

# PD6928 Ex-Proof & I.S. Loop-Powered Flow Rate/Totalizer

## Instruction Manual



**ProtEx+**

SP Ex IECEx CE

**CAP TOUCH**

**MeterView XL**

USB Install

- Fully-Approved Explosion-Proof & Intrinsically Safe Loop-Powered Flow Rate/Totalizers
- 4-20 mA Input Displayed with  $\pm 0.02\%$  of Full-Scale Accuracy
- 1.5 Volt Drop (4.7 Volt Drop with Backlight)
- 0.7" (17.0 mm) 5 Alphanumeric Characters Top Display
- 0.4" (10.2 mm) 8 Alphanumeric Characters Bottom Display
- 20-Segment Bargraph Standard
- Display Mountable at 0°, 90°, 180°, & 270°
- CapTouch Through-Glass Button Programming with Normal and Delayed Modes
- Loop-Powered Backlight with Red Backlight for Alarm Conditions
- 8-Digit Total & Grand Total Display, Up to 13 Digits Using Both Lines
- Display Rate & Total Simultaneously
- Automatic or Manual Batch Control
- Display Open Channel Flow with Programmable Exponent Feature
- 32-Point Linearization & Square Root Extraction
- (2) Open Collector Outputs Standard; Assignable to Pulse, Alarm, Timer, or Stopwatch
- (2) Optional Loop-Powered Solid-State Relays; Assignable to Alarm, Control, Timer, or Stopwatch
- Stopwatch & Timer Functions to Drive Relays & Open Collectors
- Optional Isolated 4-20 mA Analog Output
- Display Relay Runtime & Cycle Count via Relay Info Menu
- Free PC-Based MeterView XL USB Programming Software
- HART® Protocol Transparent
- Enable and Disable Backlight from Menu
- Operating Temperature Range: -40 to 75°C (-40 to 167°F)
- Installation Temperature Range: -55 to 75°C (-67 to 167°F)
- Conformal Coated PCBs for Dust & Humidity Protection
- Password Protection
- CSA Certified for Explosion-Proof / Dust-Ignition Proof / Flame-Proof
- ATEX and IECEx Certified as Intrinsically Safe and Explosion-Proof
- Flange for Wall or Pipe Mounting; Loop for Stainless Steel Tag; Holes for Tamper-Proof Seal
- Explosion-Proof, IP68, NEMA 4X Die-Cast Aluminum & Stainless Steel Enclosures
- 3-Year Warranty

## PRECISION DIGITAL CORPORATION

233 South Street • Hopkinton MA 01748 USA  
Tel (800) 343-1001 • Fax (508) 655-8990

[www.predig.com](http://www.predig.com)

**PRECISION  
DIGITAL**

# The Complete PD6900 Series

## VantageView+

### Plastic Enclosures - General Purpose



**PD6907-GP-PL**  
4-20 mA Input  
Feet & Inches Meter



**PD6908-GP-PL**  
4-20 mA Input  
Process Meter



**PD6928-GP-PL**  
4-20 mA Input  
Flow Rate/Totalizer



**PD6938-GP-PL**  
Pulse Input  
Flow Rate/Totalizer



### Aluminum Enclosures - Hazardous Area Approved



**PD6907-HA-AL**  
4-20 mA Input  
Feet & Inches Meter



**PD6908-HA-AL**  
4-20 mA Input  
Process Meter



**PD6928-HA-AL**  
4-20 mA Input  
Flow Rate/Totalizer



**PD6938-XX-AL**  
Pulse Input  
Flow Rate/Totalizer

### Stainless Steel Enclosures - Hazardous Area Approved



**PD6907-HA-SS**  
4-20 mA Input  
Feet & Inches Meter



**PD6908-HA-SS**  
4-20 mA Input  
Process Meter



**PD6928-HA-SS**  
4-20 mA Input  
Flow Rate/Totalizer



**PD6938-XX-SS**  
Pulse Input  
Flow Rate/Totalizer

## Table of Contents

Introduction .....	6
Key Features .....	7
Ordering Information .....	12
Accessories .....	12
Specifications.....	14
Display .....	14
General .....	14
Enclosure .....	15
Input.....	15
Rate/Totalizer .....	15
Batch Control.....	16
Common Open Collector & Relay Specifications.....	16
Open Collector Outputs .....	16
Solid-State Relays .....	16
4-20 mA Transmitter Output .....	16
On-Board Digital Input .....	17
MeterView XL Software .....	17
Compliance Information.....	18
Electromagnetic Compatibility .....	18
Hazardous Area Approvals.....	18
EU Declaration of Conformity.....	19
Safety Information .....	19
Installation .....	19
Unpacking .....	19
Mounting.....	20
Dimensions .....	20
Cover Jam Screw.....	20
Connections .....	21
Display & Options Modules .....	21
Connectors Labeling.....	22
Wiring Diagrams .....	24
Intrinsically Safe Wiring.....	24
I/O Parameter Table.....	24
Explosion-Proof Wiring.....	24
Current Loop (4-20 mA) Connections .....	24
Digital Input Connections .....	25
4-20 mA Output Connections .....	25
Solid-State Relay Connections.....	25
Open Collector Output Connections.....	25
Setup and Programming .....	26
Overview.....	26
CapTouch Buttons .....	26
CapTouch Buttons Delay .....	26
Turning Off CapTouch Buttons.....	26
CapTouch Button Tips & Troubleshooting .....	26
MeterView XL Programming Software.....	27
CapTouch Buttons and Status Indicators.....	28
Display Functions & Messages .....	29
Main Menu .....	33
Setting Numeric Values.....	34
Scaling the 4-20 mA Input (INPUT) .....	35
Available Engineering Units .....	36
Additional Unit Classes and Units .....	36
Setting Custom Units (CUSTOM).....	37

- Setting the Display Features (DISPLAY).....37**
  - Changing the Engineering Units (UNITS).....37
  - Changing the Decimal Point (DECP).....37
  - Enabling or Disabling Commas on the Bottom Display (COMMA).....38
  - Display Capabilities Optimization (TOP and BOTTOM).....38
  - Using 13 Digits to Display Total.....38
  - Configuring the Display (TOP and BOTTOM).....39
  - Programming the Bargraph (BARGRAPH).....40
- Programming the Outputs (OUTPUT).....40**
  - Open Collector Outputs (OPEN COLLECTR).....41
  - Solid-State Relay Outputs (RELAY).....46
  - Isolated 4-20 mA Output (4-20 mA).....53
  - Output Manual Control (CONTROL).....53
- Advanced Features Menu (ADVANCE).....54**
  - Advanced Rate Setup (ADV RATE).....54
  - Additional Engineering Units.....61
  - Advanced Total and Grand Total Setup (ADV TOTAL & ADV GTOTAL)....62
  - Low-Flow Cutoff (CUTOFF).....63
  - Noise Filter (FILTER).....63
  - Enabling Password Protection (PASSWORD).....64
  - Programmable Function Keys User Menu (USER).....65
  - Changing System Settings (SYSTEM).....67
- Meter Operation .....69**
  - CapTouch Buttons Operation .....69**
  - CapTouch Buttons .....69**
    - CapTouch Button Tips & Troubleshooting .....69
  - Function Keys Operation.....70**
  - Digital Input Operation.....70**
  - Maximum/Minimum Readings.....70**
  - Runtime & Cycle Count (INF).....71**
  - Changing Engineering Units.....71**
- Batch Controller Operation.....72**
  - Default Batch Control Operation.....72**
  - Batch Control Operation Example.....72**
  - Manual Batch Control.....75**
  - Automatic Batch Control.....76**
- Troubleshooting.....77**
  - Reset Meter to Factory Defaults.....77**
  - Determining Software Version.....77**
    - Factory Default Settings.....78
  - Troubleshooting Tips.....79**

## Table of Figures

Figure 1. Enclosure Dimensions – Front View .....20  
 Figure 2. Enclosure Dimensions – Side View .....20  
 Figure 3. Enclosure Dimensions – Top View .....20  
 Figure 4. Connector Labeling for PD6928-HA-##-LNN .....22  
 Figure 5. Connector Labeling for PD6928-HA-##-L2N .....22  
 Figure 6. Connector Labeling for PD6928-HA-##-L3N .....23  
 Figure 7. Connector Labeling for PD6928-HA-##-L5N .....23  
 Figure 8. 4-20 mA Input Connection without Backlight .....24  
 Figure 9. 4-20 mA Input Connection with Backlight .....24  
 Figure 10. Digital Input Connections .....25  
 Figure 11. 4-20 mA Output Connections .....25  
 Figure 12. Solid-State Relay Connections .....25  
 Figure 13. Open Collector Output Connections .....25



Watch the Loop-Powered Meters Video



Click or Scan

**Disclaimer**

The information contained in this document is subject to change without notice. Precision Digital Corporation makes no representations or warranties with respect to the contents hereof; and specifically disclaims any implied warranties of merchantability or fitness for a particular purpose.

**CAUTION**

- Read complete instructions prior to installation and operation of the meter.

**WARNINGS**

- This product is not recommended for life support applications or applications where malfunctioning could result in personal injury or property loss. Anyone using this product for such applications does so at his/her own risk. Precision Digital Corporation shall not be held liable for damages resulting from such improper use.
- Failure to follow installation guidelines could result in death or serious injury. Make sure only qualified personnel perform the installation.
- For Explosion-Proof / Dust-Ignition Proof / Flame-Proof applications, never remove the meter cover in explosive environments when the circuit is live.
- Cover must be fully engaged to meet Explosion-Proof / Dust-Ignition Proof / Flame-Proof requirements.

**WARNING**

Cancer and Reproductive Harm - [www.P65Warnings.ca.gov](http://www.P65Warnings.ca.gov)

**Limited Warranty**

Precision Digital Corporation warrants this product against defects in material or workmanship for the specified period under "Specifications" from the date of shipment from the factory. Precision Digital's liability under this limited warranty shall not exceed the purchase value, repair, or replacement of the defective unit. See Warranty Information and Terms & Conditions on [www.prediq.com](http://www.prediq.com) for complete details.

**Registered Trademarks**

All trademarks mentioned in this document are the property of their respective owners.

© 2023 Precision Digital Corporation.  
All rights reserved.

**Introduction**

The PD6928 ProtEX+ loop-powered explosion-proof & intrinsically safe flow rate/totalizer can be installed virtually anywhere to provide convenient and informative display of any 4-20 mA signal. They can operate down to -40°C and be installed in areas that get as cold as -55°C, however the display will cease functioning. One of the most convenient features of these instruments is their dual-line display which is typically used to display the flow rate on the 5-character alphanumeric top display and flow total, flow grand total, or a tag on the 8-character alphanumeric bottom display. The top display uses 12-segment, and the bottom display uses 14-segment alphanumeric characters for clear indication of tags, units, or alarm messages.

Further enhancing the display on these instruments is a 20-segment bargraph.

These flow rate/totalizers can be installed virtually anywhere because they get their power from the 4-20 mA loop and therefore require no separate power source. And they only drop 1.5 V (4.7 V with backlight), so they add very little burden to the loop. Additional features that allow these instruments to be installed virtually anywhere include a NEMA 4X, IP68 explosion-proof, an operating temperature range of -40 to 167°F (-40 to 75°C), conformally coated PCBs, and a backlit LCD that can be read in bright sunlight or dimly lit areas.

The ProtEX+ Series is CSA Certified as Explosion-Proof / Dust-Ignition Proof / Flame-Proof and ATEX and IECEx Certified as Intrinsically Safe and Explosion-Proof. The enclosure itself is ATEX, IECEx, CSA, and UL approved.

Free, PC-based, MeterView XL software that connects to the meter via a micro USB cable is available for programming and setup of the meters. For more details, see the [MeterView XL manual](#). Four CapTouch through-glass buttons are available to operate the instrument without removing the cover.

All models come equipped with two open collector outputs and a digital input. There are also models available with two solid-state relays and isolated 4-20 mA analog output options. The open collector outputs are useful for alarm indication or pulse output. The digital input can be used to remotely reset the total, to start/stop a timer/stopwatch, and more. The relays can be programmed for alarm indication, sample, timer, batch control, or stopwatch.

## Key Features

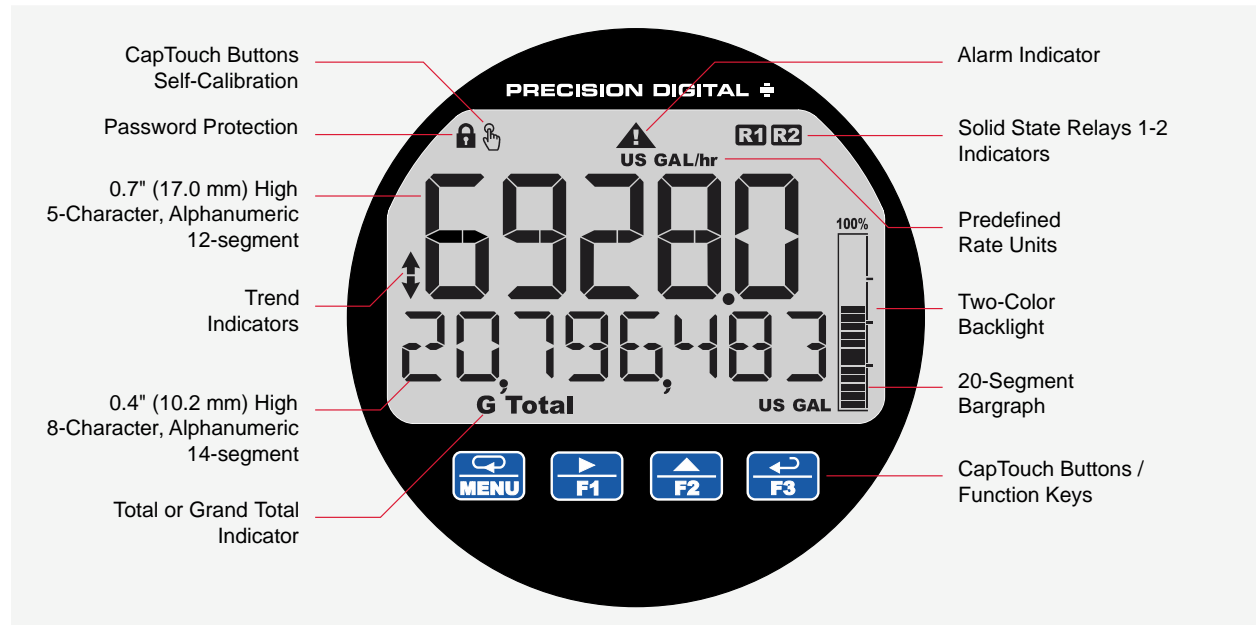

### 2X More Informative Display

The PD6928 display offers a 50% larger display area and is twice more informative than previous generations of loop-powered meters. Featuring an alphanumeric dual-line display and a 20-segment bargraph, reading and understanding process values is easy and intuitive. The addition of status indicators provides a quick glance at alarm conditions, relays, process trends, and more. Predefined display units give users even more display flexibility. Plus, the high contrast backlit LCD display is readable from far away and under various lighting conditions.

### CapTouch Through-Glass Buttons

The PD6928 is equipped with four capacitive sensors that operate as through-glass buttons so that it can be operated without removing the cover (and exposing the electronics) in a hazardous area. CapTouch buttons are designed to work under any lighting condition and to protect against false triggering. They can be disabled for security via a switch on the display module.

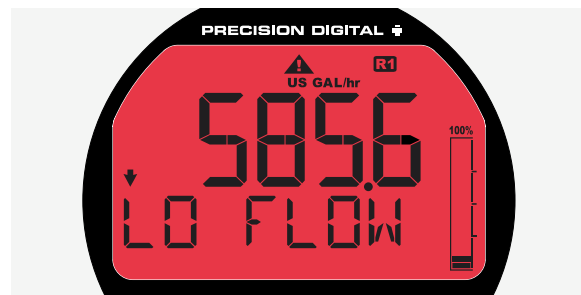

### Backlight Turns Red on Alarm

When an alarm occurs, the display can be programmed to turn red, flash, and display an alarm indicator ▲. In addition, a unique custom alarm message for each of the two relays and two open collectors can be displayed on the bottom display. These features can be activated even if no relay or open collector is connected.



CapTouch buttons have two modes of operation: Normal and Delayed. Delayed mode prevents accidental trigger of the buttons. In the Delayed mode, the buttons enter into a low sensitivity state (sleep) and they ignore quick button presses after 20 seconds of inactivity. To wake up the buttons, press and hold any button for more than 2 seconds, the buttons respond normally.

### Commas on 8-Digit Totalizer for Easy Reading

It may seem like a simple thing, but adding commas to an eight-digit number makes it easier to read:

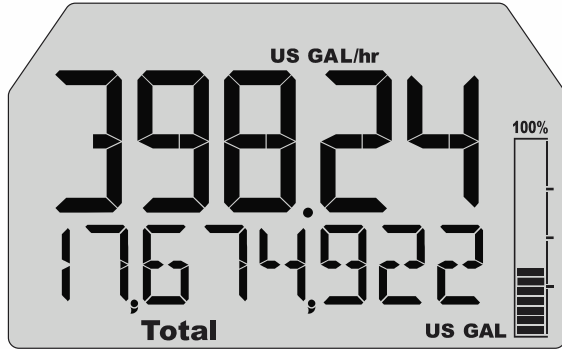

### Predefined and Custom Units

The PD6928 flow rate/totalizer has the most common predefined rate and volume units. If the desired unit is not available, the user can program a custom unit.

### 14-Segment Characters



Notice how much better letters like “T”, “N” and “K” appear as 14-segment characters on the bottom display vs. 7-segment characters found on other meters.



### Enable / Disable Backlight

The backlight may be enabled or disabled using the System - Backlight menu. The backlight is enabled by default, but the input must be wired appropriately for the backlight to function. See *Enabling or Disabling the Backlight (BACKLIGHT)* on page 68 for details.

### Multiple Outputs

- Two open collector outputs (standard)
- Two solid-state relays   (optional)
- One 4-20 mA output (optional)

The open collector outputs and relays generally operate in the same manner, with the major exception being the open collectors are not available for batch control and the relays are not available with pulse features. The open collectors and relays can be controlled either automatically or manually.

The isolated analog output signal can be configured to represent the process variable (flow rate, total, or retransmit). It can also be reverse scaled such that the meter’s high calibration value outputs 4 mA and the meter’s low calibration outputs 20 mA.

### Password Protection

A password can be set up for programming security to prevent unauthorized changes to the programmed parameter settings.



### Free MeterView XL Programming Software

The fastest and easiest way to program the meter is using the free MeterView XL programming software. This software greatly simplifies the programming process and allows the user to save configuration files for later use.

The meter connects to the PC via a provided micro-USB cable and is powered by the USB connection, so no additional power is needed during programming.



### Easy Wiring & Service

The PD6928 has been designed for easy wiring and servicing. All connections are made to removable screw terminal blocks. There are no exposed printed circuit boards.



### Wide Viewing Angle

The window and display module have been optimized to provide a wide viewing angle of approximately ±40°; nearly twice that of the competition.



### Modern and Practical Enclosure

The PD6928 NEMA 4X, IP68 enclosure provides serious protection from the elements, high impact, corrosion, and electrical interference. Plus, the extensive worldwide agency approvals allow it to be installed virtually anywhere.



#### Aluminum or Stainless Steel Enclosure

The enclosure is available in copper-free (0.3%), die-cast aluminum and type 316 stainless steel.



#### Built-In Flange for Pipe Mounting

The built-in mounting flange allows easy mounting to walls or pipes.



A slot on the back makes it easy to center the unit on a pipe. There are two 3/4" NPT threaded conduit holes for wiring.



#### Grounding Screw

A grounding screw is provided on the top of the enclosure.



#### SS Tag Attaching Loop

The enclosure is also equipped with a loop at the top to easily attach a PDA-SSTAG stainless steel tag.



#### Tamper-Proof Capability

The instrument can be made tamper-proof by inserting a wire through the built-in loop on the base of the enclosure and a hole in the lid of the enclosure and securing this wire with a lead seal.

## Rate/Totalizer Features

### Display Flow Rate & Total at the Same Time

The PD6928 can display flow rate and total at the same time. In addition, the meter can toggle between the rate and total and their corresponding units as the following example illustrates.

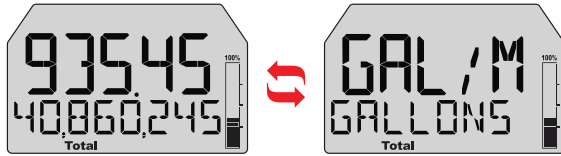

### Total Limit & Initial Value

The *Advanced – Total Count* menu allows the digit limit to be selected between 8-digit (bottom display only) and 13-digit (uses top and bottom display to display the full number).

The user can set the initial value at which the total and grand total should start counting.

### Using 13 Digits to Display Total

The top and bottom displays can be set up to display a 13-digit total.

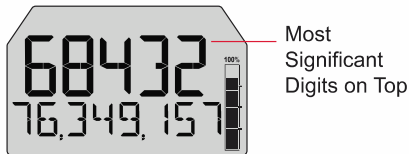

**Note:** The number above should be read as 6,843,276,349,157

### Total & Rate in Different Units

The user can select to display total in different units than the rate. For instance, a customer could measure flow rate in gallons per minute and total in acre-feet by simply selecting AF (acre-feet) units for the total. Additionally the user can enter a custom unit and conversion factor to display the total in any unit of measure.

### Rate in Units Per Second, Minute, Hour, or Day

The user may select a rate time base in units per second, minute, hour, or day. The time base is the amount of time over which the rate parameter will totalize. For example, if the rate was 10 gallons/min (and stayed constant for one minute), then the total would increase by 10 every minute.

### 4-20 mA Output for Rate or Total

The 4-20 mA output can be assigned to the rate or the total.

### Total Stored in Non-Volatile Memory

Total and grand total values, and all programmed settings are stored in non-volatile memory for a minimum of ten years if power is lost.

### Total Reset Capabilities

The total and grand total can be reset using a CapTouch button, an external contact closure on the digital input, or MeterView XL software. In addition, both total and grand total reset can be password protected to prevent unauthorized resets.

### Total Reset via CapTouch Button

The CapTouch function key F2 is set up to reset the total. If reset grand total is enabled, it is possible for the user to reset either the total or the grand total without removing the cover or the need for external devices.



### Total Reset via Digital Input

The PD6928's digital input can also be used to reset the total or grand total.

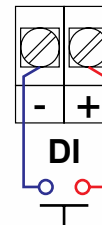

### Total Reset Password Protection

Total and grand total passwords can be set to prevent resetting the total or grand total unless a password is entered. Grand total reset can be disabled through the meter interface, and it can also be permanently disabled.

### Non-Resettable Grand Total

The user can set up the grand total to be non-resettable by selecting YES at the PERMIT menu; see page 62 for details. Once this is done, the grand total can never be reset.

### Batch Control Capabilities

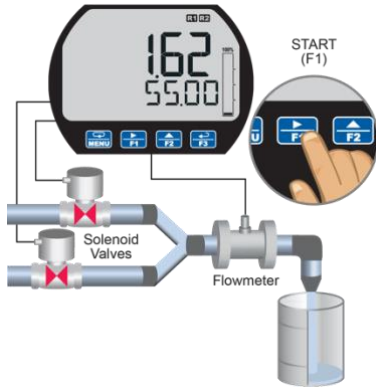

The meter can be equipped with two solid-state relays that may be set up for batch control. Selecting batch control for relay 1 enables the batching features on the meter. The top display changes to show the total and the bottom display changes to show the batch preset. The function keys also change for batch control functions such as F1 starts a batch, F2 opens the preset menu to allow the preset value to be changed, and F3 stops the currently running batch. Enabling batch control for relay 1 allows access to the batch menu under relay 2. The second relay may be programmed as a preclose relay or as another batching relay with its own preset amount.

### Manual or Automatic Operation

Batching can be set to either manual or automatic operation.

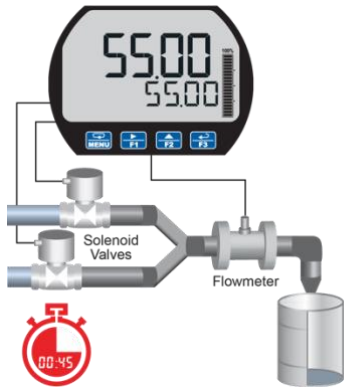

If set to automatic, then a delay before the next batch starts must be programmed.

### Count Up or Down Batching

The batch total can be set to count up or down.

### Input Signal Conditioning

To satisfy applications that require scaling in ways other than the usual 2-point linear method, the PD6928 can also be scaled for square root (DP flow), programmable exponent (open channel flow) or round horizontal tank volume calculation.

#### Square Root Linearization

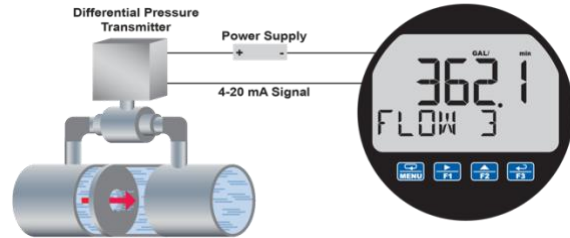

The square root function can be used to linearize the signal from a differential pressure transmitter and display flow rate in engineering units.

#### Programmable Exponent Linearization

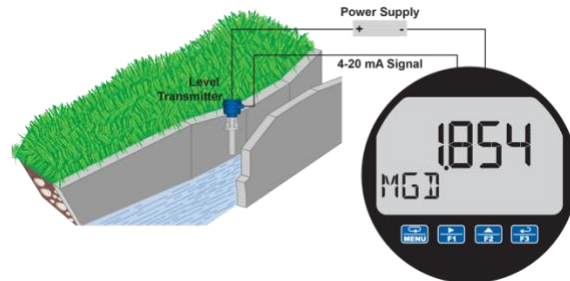

The programmable exponent can be used to linearize the signal from level transmitters in open-channel flow applications using weirs and flumes.

The PD6928, in combination with an ultrasonic level transmitter, makes for an economical way to measure and display open channel flow rate in most weirs and flumes. A guide such as the ISCO Open Channel Flow Measurement Handbook can provide the user with all the information needed: the exponent used in the flow equation for the desired flow units and the flow rate for any given head height. For example, to display the open channel flow rate from a 3" Parshall flume, the ISCO handbook advises the exponent is 1.547 and at the maximum head height of 3.0 feet, the flow rate is 3.508 MGD.

## Ordering Information

### Hazardous Area Instruments

ProtEX+ PD6928 • Flow Rate/Totalizers • Aluminum Enclosure	
Model	Description
PD6928-HA-AL-LNN	Loop-Powered Explosion-Proof & Intrinsically Safe Flow Rate/Totalizer, No Options
PD6928-HA-AL-L2N	Loop-Powered Explosion-Proof & Intrinsically Safe Flow Rate/Totalizer, Two Solid-State Relays
PD6928-HA-AL-L3N	Loop-Powered Explosion-Proof & Intrinsically Safe Flow Rate/Totalizer, 4-20 mA Analog Output
PD6928-HA-AL-L5N	Loop-Powered Explosion-Proof & Intrinsically Safe Flow Rate/Totalizer, Two Solid-State Relays & 4-20 mA Analog Output

ProtEX+ PD6928 • Flow Rate/Totalizers • Stainless Steel Enclosure	
Model	Description
PD6928-HA-SS-LNN	Loop-Powered Explosion-Proof & Intrinsically Safe Flow Rate/Totalizer, No Options
PD6928-HA-SS-L2N	Loop-Powered Explosion-Proof & Intrinsically Safe Flow Rate/Totalizer, Two Solid-State Relays
PD6928-HA-SS-L3N	Loop-Powered Explosion-Proof & Intrinsically Safe Flow Rate/Totalizer, 4-20 mA Analog Output
PD6928-HA-SS-L5N	Loop-Powered Explosion-Proof & Intrinsically Safe Flow Rate/Totalizer, Two Solid-State Relays & 4-20 mA Analog Output

#### Notes:

1. All models come with bargraph, two open collector outputs, and one digital input standard.
2. The meter comes standard with two 3/4" NPT conduit holes. To order models with M20 conduit holes instead, add -21 at the end of the part number (e.g. PD6928-HA-AL-LNN-21)

## Accessories

Model	Description
<a href="#">PD659</a>	Signal Isolators, Splitters, and Conditioners
<a href="#">PD9501</a>	Multi-Function Calibrator
<a href="#">PD9502</a>	Low-Cost Signal Generator
<a href="#">PDA1002</a>	6" DIN Rail Mounting Kit
<a href="#">PDA1024-01</a>	24 VDC Transmitter Power Supply for DIN Rail
<a href="#">PDA6846</a>	Steel 2" U-Bolt Kit. All Material: Zinc Plated Steel; (1) U-Bolt for 2" Pipe with (2) Washers, (2) Lock Washers, and (2) Nuts
<a href="#">PDA6846-SS</a>	Stainless Steel 2" U-Bolt Kit. All Material: Stainless Steel; (1) U-Bolt for 2" Pipe with (2) Washers, (2) Lock Washers, and (2) Nuts
<a href="#">PDAPLUG75</a>	3/4" NPT 316 Stainless Steel Conduit Plug with Approvals
<a href="#">PDAREDUCER-75M-50F</a>	M-3/4" NPT to F-1/2" NPT Reducer with Approvals
<a href="#">PDAREDUCER-75M-M20F</a>	M-3/4" NPT to F-M20 Reducer with Approvals
<a href="#">PDA-SSTAG</a>	Custom Stainless Steel Tag (see website for convenient ordering form)

#### WARNING

- Accessories do not carry hazardous area approvals unless otherwise specified and are thus not suitable for location in hazardous areas. The use of additional protective devices may allow them to be installed in a safe area and connected to a device in a hazardous area. User should consult a professional engineer to determine suitability of these products for their specific application.

**PDA1024-01 24 VDC Power Supply**



The PDA1024-01 is a DIN rail mounted 1.5 A, 24 VDC power supply that can be used to power the 4-20 mA transmitter.

**PDA6846 2" U-Bolt Kits**



The PDA6846 U-Bolt Kits provide a convenient way to mount the meter to 1.5" or 2" pipes. They are available in steel and stainless steel.

**PDA-SSTAG Stainless Steel Tag**



The PDA-SSTAG is a laser etched stainless steel tag that can be customized with three lines of text. Each tag comes with a stainless steel wire and lead seal for easy mounting wherever you need.

**PD9501 Multi-Function Calibrator**



This [PD9501](#) Multi-Function Calibrator has a variety of signal measurement and output functions, including voltage, current, thermocouple, and RTD.

**PD9502 Low-Cost Signal Generator**



The [PD9502](#) is a low-cost, compact, simple to use 4-20 mA or 0-10 VDC signal generator. It can easily be set for 0-20 mA, 4-20 mA, 0-10 V or 2-10 V ranges. Signal adjustment is made with a one-turn knob. A wall plug is provided with the instrument. Optional USB power bank is available.

## Specifications

Except where noted all specifications apply to operation at +25°C.

### Display

<b>Display</b>	Dual-line LCD with backlight. Both lines: alphanumeric Top: 0.7" (17.8 mm) 5 digits, 12-segment Bottom: 0.4" (10.2 mm) 8 characters, 14-segment Display may be programmed to turn red and flash a user-defined message on alarm condition.
<b>On-Screen Indicators</b>	See <i>CapTouch Buttons and Status Indicators</i> on page 28 for details.
<b>Top Display</b>	5 digits (-9999 to 99999) or 5 characters (all capital & most lower-case letters)
<b>Bottom Display</b>	8 digits (-9,999,999 to 99,999,999; separated by commas) or 8 characters (all capital & most lower-case letters)
<b>Backlight</b>	Powered by 4-20 mA loop Intensity varies with signal level
<b>Bargraph</b>	20 segments (100% label at top fixed) Assignable to rate, total, or off Scale: 0 to 100%
<b>Decimal Point</b>	Up to four decimal places on top display and up to seven decimal places on bottom display
<b>Commas</b>	Commas to indicate 1000s (e.g. 88,987,628) on the bottom display only
<b>Dual-Scale Feature</b>	If the totalizer is disabled, the input can be displayed in different scales on the top and bottom displays. For instance, the top display could display the flow in GPM and the bottom display could display that same input in CFM.
<b>Alarm Indication</b>	Programmable: loop-powered red backlight, flashing display, alarm symbol ▲, bargraph segment flashes on alarm.
<b>Custom Alarm Messages</b>	Programmable for each relay/open collector: 8 characters maximum; displayed every 10 sec for 1 sec on bottom display. May be turned off.
<b>Display Update Rate</b>	Ambient > -10°C: 1 Update/Second Ambient = -20°C: 1 Update/2 Seconds From -20°C to -40°C the update rate slows down 1 second for every -2°C (e.g. at -24°C, 1 update/4 seconds).
<b>Overrange</b>	Top: 99999; Bottom: 99,999,999 (flashing)
<b>Underrange</b>	Top: -9999; Bottom: -9,999,999 (flashing)

### General

<b>Programming Method</b>	Four CapTouch through-glass buttons when cover is installed. The CapTouch buttons can be used with the cover removed. Free PC-based USB MeterView XL programming software.
<b>Environmental</b>	Operating temperature range: -40 to 75°C (-40 to 167°F) Storage temperature range: -55 to 85°C (-67 to 185°F) Installation temperature range: -55 to 75°C (-67 to 167°F) (The display ceases to function, however inputs and outputs continue to operate) Relative humidity: 0 to 90% non-condensing Printed circuit boards are conformally coated
<b>Noise Filter</b>	Averages the input signal over a period of time between 1 and 16 seconds to dampen the effects of a noisy signal that causes a jumpy display.
<b>Filter Bypass</b>	0.0 to 99.9% of full scale. Input signal changes that are greater than the bypass value are displayed immediately.
<b>Recalibration</b>	Recommended at least every 12 months.
<b>Max / Min Display</b>	Max / min readings reached by the process are stored until reset by the user or until power to the meter is turned off.
<b>Tare</b>	If the totalizer is disabled, the Tare function zeros out the meter to remove the weight of a container. Tare function can be assigned to a function key or the digital input.
<b>Password</b>	There are three separate passwords available that can be set independently of each other: Main, Total, and Grand Total. The Main password prevents access to the meter Programming Mode. Total and Grand Total passwords prevent resetting the total and grand total, respectively.
<b>Non-Volatile Memory</b>	Total and Grand Total values, and all programmed settings are stored in non-volatile memory for a minimum of ten years if power is lost.
<b>Normal Mode Rejection</b>	64 dB at 50/60 Hz
<b>Connections</b>	Removable screw terminal blocks Display terminals: accept 16 to 30 AWG wire Relay terminals: accept 12 to 26 AWG wire 4-20 mA output: accept 16 to 30 AWG wire
<b>Tightening Torque</b>	Display terminals: 2.5 lb-in (0.28 Nm) Relay terminals: 4.5 lb-in (0.5 Nm) 4-20 mA output terminals: 2.5 lb-in (0.28 Nm)
<b>Overall Dimensions</b>	5.25" x 5.65" x 4.80" (133 x 144 x 122 mm) (W x H x D)
<b>Weight</b>	Aluminum: 5.1 lbs (2.3 kg) Stainless Steel: 9.4 lbs (4.3 kg)
<b>Warranty</b>	3 years parts and labor. See Warranty Information and Terms & Conditions on <a href="http://www.prediq.com">www.prediq.com</a> for complete details.

## Enclosure

<b>Material</b>	-AL Models: ASTM A413 LM6 die-cast aluminum, copper-free, enamel coated. -SS Models: ASTM A743 CF8M investment-cast 316 stainless steel
<b>Gasket</b>	Fluoroelastomer
<b>Rating</b>	NEMA 4X, IP68 explosion-proof
<b>Color</b>	-AL: Blue; -SS: Silver
<b>Window</b>	Borosilicate glass
<b>Conduits</b>	Two 3/4" NPT threaded conduit openings. M20 conduits are available. See <i>Ordering Information</i> on page 12 for details.
<b>Conduit Stopping Plug</b>	Sold separately. See <i>Ordering Information</i> on page 12 for details.
<b>Flange</b>	Built-in flange for wall and pipe mounting.
<b>Tamper-Proof Seal</b>	Enclosure lid may be secured with tamper-proof seal.
<b>Instrument Tag Loop</b>	Built-in loop for securing stainless steel tag
<b>Overall Dimensions</b>	5.25" x 5.65" x 4.80" (133 x 144 x 122 mm) (W x H x D)
<b>Weight</b>	Aluminum: 4.8 lbs (2.18 kg) Stainless Steel: 9.0 lbs (4.08 kg)
<b>ATEX &amp; IECEx (Enclosure only)</b>	Flameproof protection Ⓜ II 2GD Ex db IIC Gb Ex tb IIIC Db IP66/IP68 Tamb: -55°C to +85°C Certificate No.: Sira 19ATEX1252U Certificate No.: IECEx SIR 19.0075U
<b>CSA (Enclosure only)</b>	Class I, Division 1, Groups A, B, C, D Class II, Division 1, Group E, F, G; Class III Ex db IIC Gb Ex tb IIIC Db Class I, Zone 1, AEx db IIC Gb; Zone 21, AEx tb IIIC Db IP66/IP68/TYPE 4X Tamb: -55°C to +85°C Certificate No.: 80011200
<b>UL (Enclosure only)</b>	Class I, Division 1, Groups A, B, C and D Class II, Division 1, Groups E, F and G Class III; Class I, Zone 1, AEx db IIC Gb Zone 21, AEx tb IIIC Ex db IIC Gb Ex tb IIIC Db IP66/IP68/TYPE 4X Tamb: -55°C to +85°C Certificate Number: E518920

**Note:** The above approvals are for the enclosure only. See *Hazardous Area Approvals* on page 18 for approvals on the entire instrument.

## Input

<b>Input</b>	4-20 mA
<b>Accuracy</b>	±0.02% of span ±1 count, Square root and programmable exponent: 10-100% FS
<b>Voltage Drop</b>	Without backlight: 1.5 V maximum, With backlight: 4.7 V maximum
<b>Equivalent Resistance</b>	Without backlight: 75 Ω @ 20 mA With backlight: 235 Ω @ 20 mA
<b>Input Overload</b>	Over current protection to 1 A maximum, Over voltage protection to 30 VDC max (Between mA+ and mA- / BL-)
<b>Temperature Drift</b>	25 PPM/°C from -40 to 75°C ambient
<b>Function</b>	Rate: Linear (2-32 points), square root, or programmable exponent If the totalizer is disabled, PV1 and PV2: Linear (2-32 points) or round horizontal tank
<b>Low-Flow Cutoff</b>	0.1 to 999,999 or disable. Point below at which the display always shows zero.
<b>HART Transparency</b>	The meter does not interfere with existing HART communications; it displays the 4-20 mA primary variable and it allows the HART communications to pass through without interruption. The meter is not affected if a HART communicator is connected to the loop. The meter does not display secondary HART variables.

## Rate/Totalizer

<b>Rate Display</b>	Top display: -9999 to 99999; Bottom display: -9,999,999 to 99,999,999 (with commas)
<b>Total &amp; Grand Total Display</b>	Top display: 0 to 999999; Bottom display: 0 to 99,999,999 (with commas)
<b>13-Digit Total &amp; Grand Total</b>	Up to 9,999,999,999,999 using both lines with 13-digit total feature enabled.
<b>Total Decimal Point</b>	Up to four decimal places on top, up to seven decimal places on bottom. Total decimal point is independent of rate decimal point.
<b>Totalizer</b>	Calculates total based on rate and rate units to display total in engineering units. A custom factor must be programmed if using custom defined units.
<b>Time Base</b>	Seconds, Minutes, Hours, Days
<b>Totalizer Rollover</b>	Totalizer rolls over when display exceeds 99,999,999 (9,999,999,999,999 if 13-digit limit enabled). Relay status reflects display.
<b>Total &amp; Grand Total Reset</b>	Via CapTouch button, external contact closure on digital input, or MeterView XL.
<b>Total &amp; Grand Total Reset Passwords</b>	Total and grand total passwords may be entered to prevent resetting the total or grand total unless a password is entered.
<b>Non-Resettable Grand Total</b>	Grand total reset may be disabled through the meter interface. Grand total reset may be permanently disabled by selecting YES at the PERMLCK menu.

### CAUTION

- Once the Grand Total has been programmed as "non-resettable" the feature **CANNOT** be disabled.

**Non-Volatile Memory** Total and Grand Total values are stored in non-volatile memory for a minimum of ten years if power is lost.

## Batch Control

<b>Methods</b>	Automatic or Manual, count up or count down
<b>Manual Batch Start</b>	Pressing F1 function key starts the batch
<b>Manual Batch Pause/Stop</b>	Pressing F3 once pauses the batch, pressing it twice cancels the batch
<b>Automatic Batching</b>	The ProtEX+ can be used as an automatic batch controller where batches run continuously without operator input
<b>Batching Relay Operation</b>	Single or dual-relay batching with optional preclose for dual-stage operation
<b>Batch Preset</b>	Set via F2 function key anywhere between 0.0001 to 99,999 based on batch total decimal point. If batch total is assigned to bottom, the preset can be up to 8 digits.
<b>Batch Preclose</b>	For two-stage batch application, a preclose value can be set to close the main flow line.
<b>Automatic Batch Restart Delay</b>	1 to 9,999 seconds. The batch will automatically restart after completion of the last batch.

## Common Open Collector & Relay Specifications

<b>Number</b>	Two open collectors & two relays
<b>High or Low Alarm</b>	User programmable for high or low alarm
<b>Alarm Deadband</b>	0-100% FS, user programmable
<b>Output Assignment</b>	Alarm, Timer, Stopwatch, or Disable
<b>Alarm Output Source</b>	Assign to rate, total, grand total, or digital input
<b>On &amp; Off Time Delay</b>	0 to 9,999 seconds
<b>Fail-Safe Operation</b>	Independent for each open collector and relay. Fail-safe on, the output is on under normal conditions. Fail-safe off, the output is on under alarm conditions.
<b>Alarm Operation</b>	Automatic, automatic with manual override, latching (manual reset anytime), latching with reset after cleared (manual reset only after alarm has cleared)
<b>Alarm Indication</b>	Programmable: loop-powered red backlight, flashing display, alarm symbol ▲, bargraph segment flashes on alarm.
<b>Custom Alarm Messages</b>	Programmable for each relay/open collector: 8 characters maximum; displayed every 10 sec for 1 sec on bottom display. May be turned off.
<b>Alarm Acknowledge</b>	CapTouch ACK button or external digital input resets output and screen indication.
<b>Auto Initialization</b>	When power is applied to the meter, open collectors and relays will reflect the state of the input to the meter.
<b>Timer Output</b>	One-shot or Continuous Off Time Delay: 1 sec to 99:59:59 (hrs:min:sec) On Time: 1 sec to 99:59:59 (hrs:min:sec)
<b>Stopwatch</b>	Output turns on when started and off when stopped.

## Open Collector Outputs

<b>Rating</b>	Isolated open collector, sinking NPN 5-30 VDC @ 150 mA maximum
<b>Output Assignment</b>	Pulse, Alarm, Timer, Stopwatch, or Disable
<b>Pulse Output Source</b>	Pulse output based on Rate, Total, Grand Total, or Test Frequency, Alarm, Timer, Total Reset, Stopwatch on/off, or Disable
<b>Pulse Output Factor</b>	0.000001 to 999,999.9
<b>Pulse Width</b>	0.5 ms @ 1 kHz; 500 ms @ 1 Hz; 50% duty cycle
<b>Pulse Output Frequency</b>	1,000 Hz maximum
<b>Quadrature Pulse Output</b>	Available for Output 2 (90° behind Output 1) 500 Hz max
<b>Alarm Output Source</b>	Assign to Rate, Total, Grand Total or Digital Input

## Solid-State Relays

<b>Rating</b>	250 VAC/VDC @ 0.5 A resistive 38 VA; 250 VAC; 0.3 A pilot duty (inductive) 13 VA; 250 VDC; 0.3 A pilot duty (inductive)
<b>Noise Suppression</b>	Metal oxide varistors across outputs
<b>Relay Assignment</b>	Alarm, Sample, Timer, Batch, Stopwatch on/off, or Disable
<b>Alarm Output Source</b>	Assign to Rate, Total, Grand Total, or Digital Input
<b>Relay Runtime</b>	Meter will keep track of how long each relay has operated and display this information.
<b>Relay Cycles</b>	Meter will keep track of how many times the relays have cycled and display this information.

## 4-20 mA Transmitter Output

<b>Accuracy</b>	±0.05% FS ±0.001mA
<b>Output Source</b>	Rate, total, re-transmit; reverse scaling allowed
<b>Scaling Range</b>	1.00 to 23.0 mA
<b>Disable</b>	High impedance state, less than 1 mA
<b>Calibration</b>	Factory calibrated 4.00 to 20.00 mA
<b>Underrange</b>	1.0 mA, 3.5 mA, or 3.8 mA (If input < 3.5 mA); or Off; user selectable
<b>Overrange</b>	20.5 mA, 20.8 mA, or 23.0 mA (If input > 20.5 mA); or Off; user selectable
<b>Isolation</b>	500 V input-to-output
<b>Temperature Drift</b>	0.5 µA/°C max from -40 to 75°C ambient
<b>External Loop Power Supply</b>	7.0 VDC to 30.0 VDC maximum
<b>Output Loop Resistance</b>	10-750 Ω @ 24 VDC; 10-1100 Ω @ 30 VDC



## On-Board Digital Input

<b>Function</b>	Remote operation of front-panel buttons, acknowledge/reset relays, reset total, reset max/min values, start/stop batch, etc. See User section of <i>Display Functions &amp; Messages</i> on page 29 for a complete list of capabilities.
<b>Contacts</b>	2.1 VDC on contact. Connect normally open contacts across DI+ and DI-
<b>Logic Levels</b>	Logic High: 2.4 to 30 VDC (max) Logic Low: 0 to 0.9 VDC

## MeterView XL Software

<b>Availability</b>	Free download from <a href="http://www.predig.com">www.predig.com</a>
<b>System Requirements</b>	Microsoft® Windows® 7 & 10
<b>Communications</b>	USB 2.0 (Standard USB A to Micro USB B) Cable provided
<b>Configuration</b>	Configure all parameters on the meter. Configure meters one at a time.
<b>Configuration Files</b>	Generate with or without meter connected; Save to file for later use.
<b>USB Power Connection</b>	Meter is powered by USB connection during programming, if 4-20 mA loop is not connected.

### WARNING

- The meter should only be connected to a computer while it is located in a safe area

<b>Compatibility</b>	Programs created for Loop Leader and Loop Leader+ may be run on either meter. Programs created for VantageView+ and ProtEX+ can be run on either meter. No other program sharing is permissible.
----------------------	--



To download the latest MeterView XL programming software and manual, visit [predig.com/meterviewxl](http://predig.com/meterviewxl).

## Compliance Information

### Electromagnetic Compatibility

<b>EMC Emissions</b>	<ul style="list-style-type: none"> <li>CFR 47 FCC Part 15 Subpart B Class A emissions requirements (USA)</li> <li>ICES-003 Information Technology emissions requirements (Canada)</li> <li>AS/NZS CISPR 11 Group 1 Class A ISM emissions requirements (Australia/New Zealand)</li> <li>EN 55011 Group 1 Class A ISM emissions requirements (EU)</li> <li>EN 61000-6-4 Emissions requirements for Heavy Industrial Environments - Generic</li> </ul>
<b>EMC Emissions and Immunity</b>	EN 61326-1 EMC requirements for Electrical equipment for measurement, control, and laboratory use – industrial use

### Hazardous Area Approvals

<b>CSA</b>	<p>Explosion-proof for use in: Class I, Division 1, Groups B, C and D</p> <p>Dust-ignition proof for use in: Class II/III, Division 1, Groups E, F and G; T6</p> <p>Flame-proof for use in: Zone 1, Ex d IIC T6 Ta = -55 to 75°C.</p> <p>Enclosure: Type 4X &amp; IP66/IP68. Certificate number: 2325749</p>
<b>ATEX</b>	<p>Intrinsically safe for use in:</p> <p>⊕ II 1 G D Ex ia IIC T4 Ga Ex ia IIIC T200°C Da Ta = -55 to 75°C Enclosure: Type 4X &amp; IP66/IP68 Install per Control Drawing DW2636 (contained within <a href="#">LIM6908-2</a>) Certificate number: CML 18ATEX2089X</p> <p>Explosion-proof for use in:</p> <p>⊕ II 2 G D Ex db IIC T6 Gb Ex tb IIIC T85°C Db IP68 Ta = -55 to 75°C Certificate number: Sira 10ATEX1116X</p>
<b>IECEX</b>	<p>Intrinsically safe for use in:</p> <p>Ex ia IIC T4 Ga Ex ia IIIC T200°C Da Ta = -55 to 75°C Enclosure: Type 4X &amp; IP66/IP68 Install per Control Drawing DW2636 (contained within <a href="#">LIM6908-2</a>) Certificate number: IECEX CML 18.0050X</p> <p>Explosion-proof for use in:</p> <p>Ex db IIC T6 Gb Ex tb IIIC T85°C Db IP68 Ta = -55 to 75°C Certificate number: IECEX SIR 10.0056X</p>

### ATEX/IECEX Special Conditions for Safe Use

The following conditions relate to safe installation and/or use of the equipment.

- The equipment loop/power port shall be connected to an intrinsically safe barrier with  $U_o \geq 5.8V$
- The 4-20 mA input port shall be connected to an intrinsically safe barrier with  $U_o \geq 5.1V$
- The PD6928-HA-AL enclosure is manufactured from aluminum. In rare cases, ignition sources due to impact and friction sparks could occur. This shall be considered during installation, particularly if the equipment is installed in a Zone 0 location.
- All cable entries into the equipment shall be via cable glands or conduit which provide a minimum degree of protection of IP54.
- The equipment may not have 500V isolation between the circuit and earth. This shall be taken into account when installing the equipment.
- The equipment label and epoxy coating may generate an ignition-capable level of electrostatic charges under certain extreme conditions. The user should ensure that the equipment is not installed in a location where it may be subjected to external conditions (such as high-pressure steam) which might cause a buildup of electrostatic charges on non-conducting surfaces. Additionally, cleaning of the equipment should be done only with a damp cloth.
- Flameproof joints are not intended to be repaired.
- All entry closure devices shall be suitably certified as "Ex d", "Ex t" and "IP66/68" as applicable. Suitable thread sealing compound (non-setting, non-insulating, non-corrosive, not solvent based, suitable for the ambient rating) must be used at the NPT conduit entries to achieve the IPx8 rating while maintaining the Ex protection concept.

### Year of Construction

This information is contained within the serial number with the first four digits representing the year and month in the YYMM format.

### For European Community:

The PD69XX Series must be installed in accordance with the ATEX directive 2014/34/EU, the product certificates CML 18ATEX2089X, Sira 10ATEX1116X, IECEX CML 18.0050X, IECEX SIR 10.0056X and the product manual.

## EU Declaration of Conformity

For shipments to the EU and UK, a Declaration of Conformity was printed and included with the product. For reference, a Declaration of Conformity is also available on our website [www.prediq.com/docs](http://www.prediq.com/docs).

## Safety Information

### CAUTION

- Read complete instructions prior to installation and operation of the meter.

### WARNINGS

- Hazardous voltages exist within enclosure. Installation and service should be performed only by trained service personnel.
- Service requiring replacement of internal components must be performed at the factory.
- Control room equipment must not use or generate more than 250 VRMS or VDC.
- Hazardous location installation instructions for associated apparatus (barrier) must be followed when installing this equipment.
- For safe installation of an ATEX approved transmitter in series with PD6928 loop-powered flow rate/totalizers, the hazardous location installation instructions for the transmitter, PD6928 loop-powered flow rate/totalizer, and associated apparatus (barrier) must be compatible.
- PD6928 loop-powered flow rate/totalizers do not add capacitance or inductance to the loop under normal or fault conditions.
- Substitution of components may impair hazardous location safety.
- Equipment contains non-metallic materials and therefore special care and consideration should be made to the performance of these materials with respect to chemicals which may be present in a hazardous environment.

## Installation

To access the connectors, remove the enclosure cover and unclip the display module by pulling it from the enclosure. The display module may be disconnected from the options module to facilitate wiring to the options module.

Refer to Control Drawing DW2636 (contained within [LIM6908-2](#)) for details related to intrinsically safe field wiring.

### WARNING

Explosion-Proof / Dust-Ignition Proof / Flame-Proof

- Disconnect from supply before opening enclosure. Keep cover tight while circuits are live. Conduit seals must be installed within 18" (450mm) of the enclosure.

## Unpacking

Remove the meter from box. Inspect the packaging and contents for damage. Report damages, if any, to the carrier.

If any part is missing or the meter malfunctions, please contact your supplier or the factory for assistance.

## Mounting

The PD6928 has a slotted mounting flange that may be used for pipe mounting or wall mounting. Alternatively, the unit may be supported by the conduit using the conduit holes provided. Refer to *Figure 1* and *Figure 2*.

- ⚠ WARNING**
- Do not attempt to loosen or remove flange bolts while the meter is in service.

## Dimensions

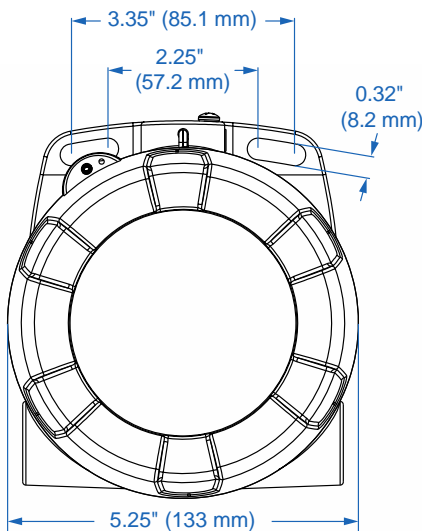

Figure 1. Enclosure Dimensions – Front View

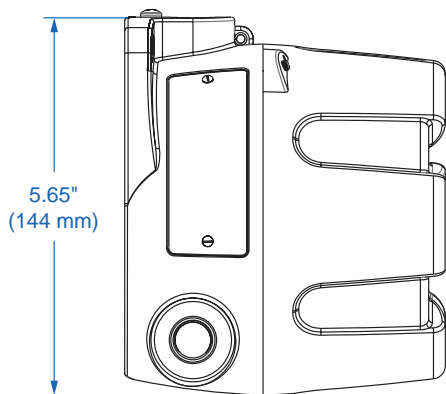

Figure 2. Enclosure Dimensions – Side View

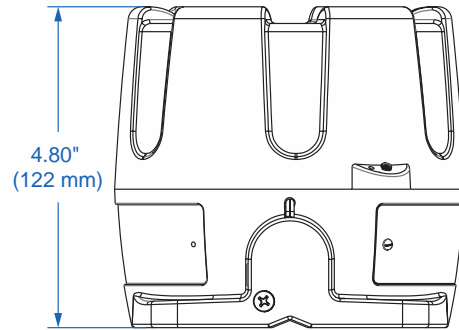

Figure 3. Enclosure Dimensions – Top View

ENCLOSURE  
**CAD**  
DIMENSIONAL DRAWINGS

Download free 3-D CAD files of these instruments to simplify your drawings!

[predig.com/documentation-cad](http://predig.com/documentation-cad)

## Cover Jam Screw

The cover jam screw should be properly installed once the meter has been wired and tested in a safe environment. The cover jam screw is intended to prevent the removal of the meter cover in a flame-proof environment without the use of tools. Using a M2 hex wrench, turn the screw clockwise until the screw contacts the enclosure's base. Turn the screw an additional 1/4 to 1/2 turn to secure the cover.



- ⚠ CAUTION**
- Excess torque may damage the threads, screw head, and/or wrench.

## Connections

To access the connectors, remove the enclosure cover and unclip the display module by pulling it from the enclosure. Signal, backlight, open collector, and digital input connections are made to removable connectors on the display module. Relays and 4-20 mA output connections (if installed) are made to removable connectors on the options module mounted in the base of the enclosure. The display module may be disconnected from the options module to facilitate wiring to the options module. Grounding connections are made to the two ground screws provided on the base of the enclosure, one internal and one external.

### **⚠ WARNINGS**

- Observe all safety regulations. Electrical wiring should be performed in accordance with all agency requirements and applicable national, state, and local codes to prevent damage to the meter and ensure personnel safety.
- Static electricity can damage sensitive components.
- Observe safe handling precautions for static-sensitive components.
- Use proper grounding procedures/codes.
- If the meter is installed in a high voltage environment and a fault or installation error occurs, high voltage may be present on any lead or terminal.

## Display & Options Modules

The display module snaps into built-in rails on the enclosure ensuring a secure and perfect fit every time. No tools are needed to install or remove it. The options module is screwed into the base of the enclosure. Both modules completely encase the printed circuit boards.



Options Board (Left) and Display Module (Right)



Options Board Connected to Display Module



Options Board Mounted on the Bottom of Enclosure



Display Module Mounted on Built-In Rails

## Connectors Labeling

The following graphics show the locations of the connectors for each available configuration.

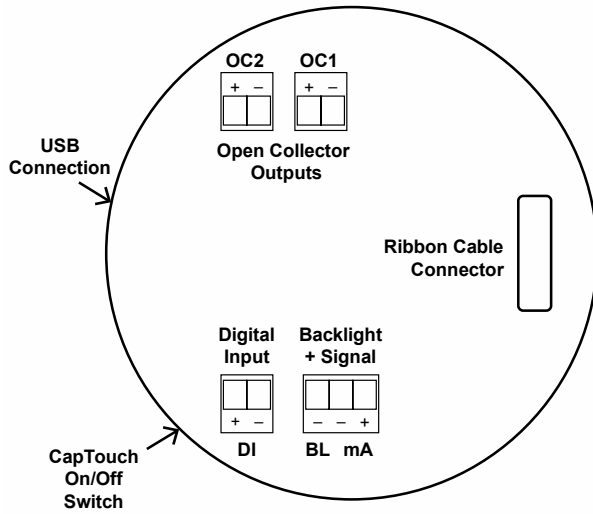

Figure 4. Connector Labeling for PD6928-HA-##-L1N

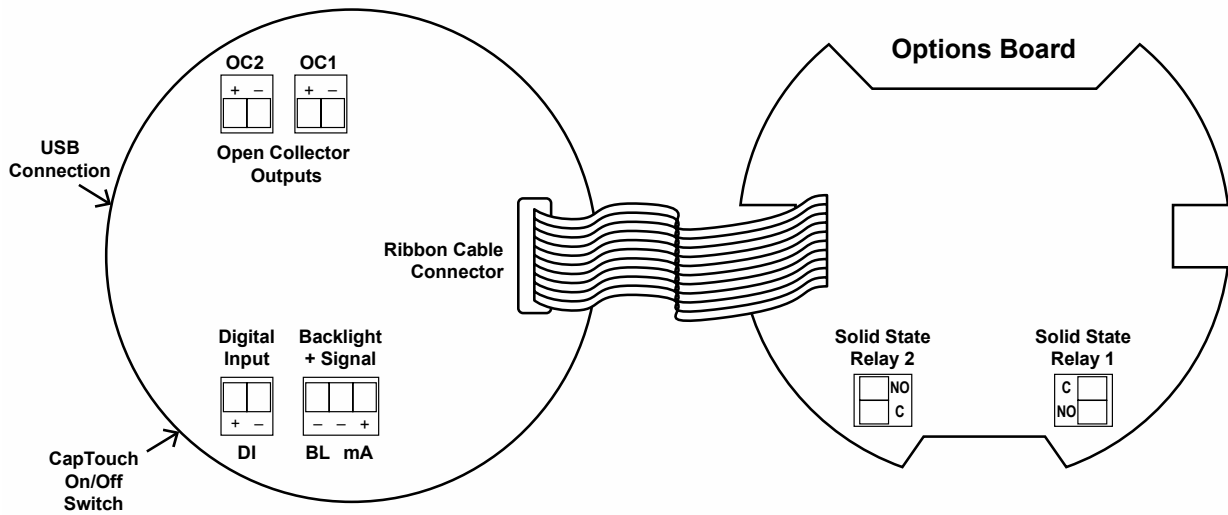

Figure 5. Connector Labeling for PD6928-HA-##-L2N

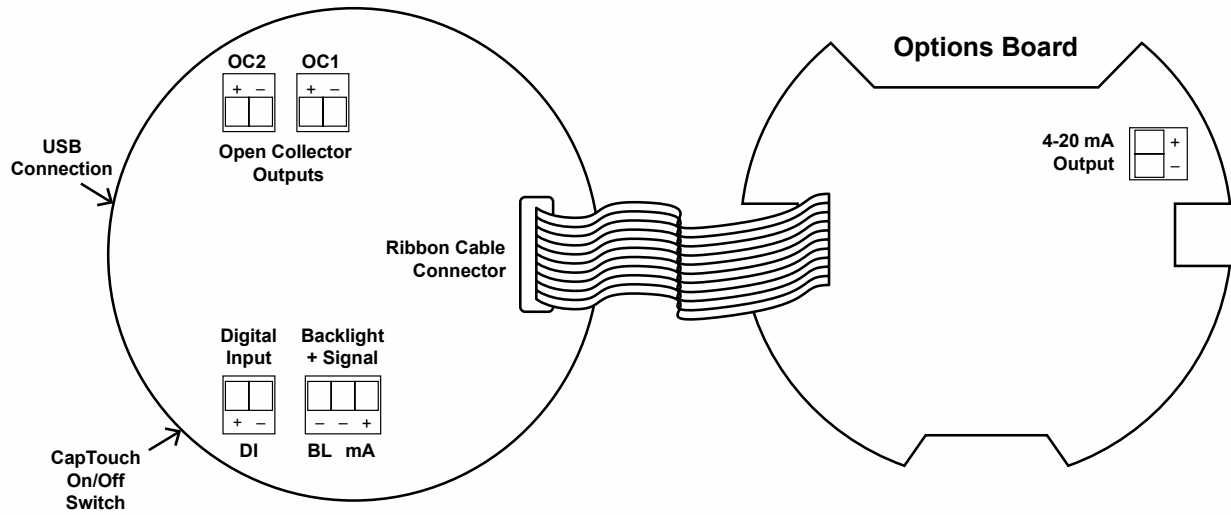

Figure 6. Connector Labeling for PD6928-HA-##-L3N

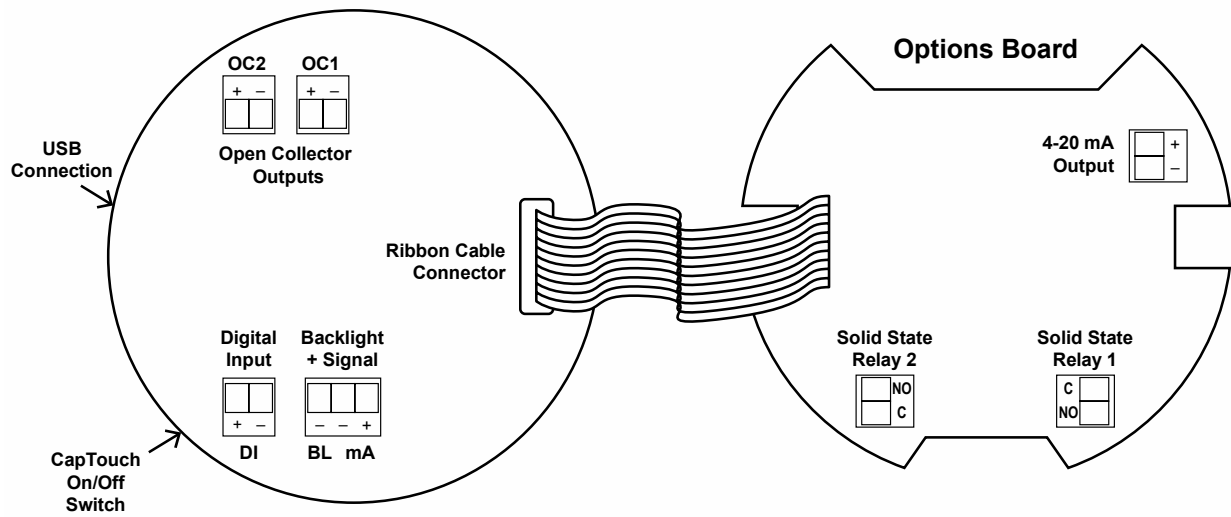

Figure 7. Connector Labeling for PD6928-HA-##-L5N

# Wiring Diagrams

## Intrinsically Safe Wiring

**⚠ WARNING**

1. PD6928 installation must be performed in accordance with control drawings included in the [LIM6908-2](#), in order to meet agency approval ratings.
  - For ATEX certification, barrier and transmitter must be ATEX Certified with Entity Parameters and must be connected per manufacturer's instructions.
  - Service requiring replacement of internal components must be performed at the factory.
  - Entire meter assembly (electronic assembly) may be replaced in the field with a unit supplied from the factory labeled "Field Modification".

### I/O Parameter Table

4-20 mA Loop Input			Switch Port		
Ui	=	30 V	Ui	=	30 V
li	=	175 mA	li	=	175 mA
Pi	=	1 W	Pi	=	1 W
Ci	=	0	Ci	=	0
Ll	=	0	Ll	=	0
Open Collector Outputs			Backlight Terminal		
Ui	=	30 V	Ui	=	30 V
li	=	175 mA	li	=	175 mA
Pi	=	1 W	Pi	=	1 W
Ci	=	0	Ci	=	0
Ll	=	0	Ll	=	0
Power Supply Input			mA Output		
Ui	=	30 V	Ui	=	30 V
li	=	175 mA	li	=	175 mA
Pi	=	1 W	Pi	=	1 W
Ci	=	0	Ci	=	0
Ll	=	0	Ll	=	0
Relay Outputs					
Ui	=	30 V			
li	=	1000 mA			
Pi	=	1 W			
Ci	=	0.013 uF			
Ll	=	0			
Uo	=	11.55 V			
Io	=	1 mA			
Po	=	0.012 W			

## Explosion-Proof Wiring

### Current Loop (4-20 mA) Connections

Signal connections are made to a three-terminal connector. See *Connectors Labeling* on page 22. The following figures show a 4-20 mA current loop connected to the meter. *Figure 8* shows the connection without the backlight and *Figure 9* shows the connection with the backlight (the backlight can be disabled/enabled in the SYSTEM menu, if connected). The meter and the backlight are powered by the 4-20 mA current loop.

There are no switches or jumpers to set up for the input. Setup and programming are performed through the CapTouch buttons or PC-based software.

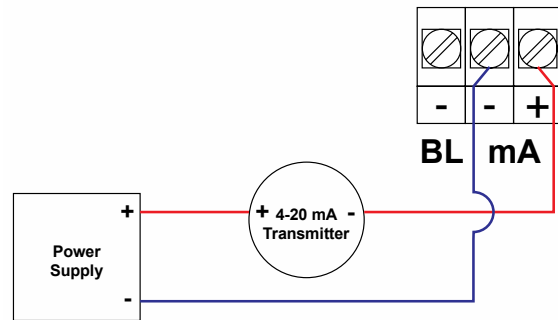

Figure 8. 4-20 mA Input Connection without Backlight

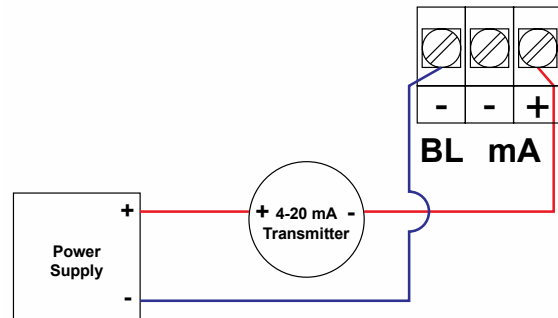

Figure 9. 4-20 mA Input Connection with Backlight

The current input is protected against current overload up to 1 amp. The display may or may not show a fault condition depending on the nature of the overload.



### Digital Input Connections

A digital input is standard on the meter. This digital input is connected with a normally open contact across DI+ and DI-, or with an active low signal applied to DI+ and DI-.

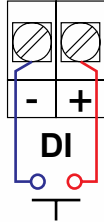

Figure 10. Digital Input Connections

### 4-20 mA Output Connections

Connections for the 4-20 mA transmitter output are made to the connector terminals labeled 4-20 mA Output on Figure 6, page 23. The 4-20 mA output must be powered from an external power supply.

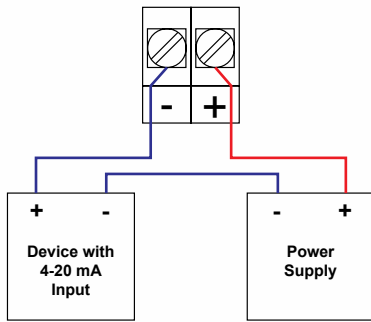

Figure 11. 4-20 mA Output Connections

### Solid-State Relay Connections

Relay connections are made to two-terminal connectors, as shown on Figure 5, page 22. Each relay's C terminal is common only to the normally open (NO) contact of the corresponding relay.

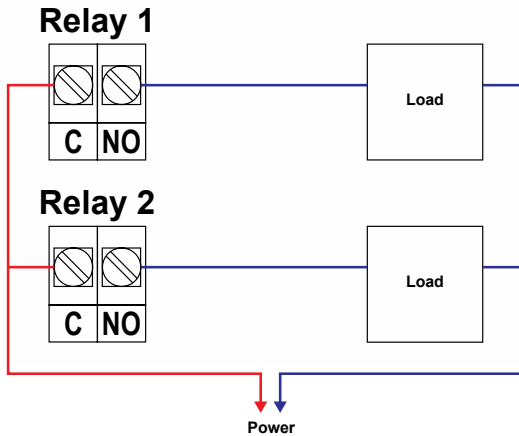

Figure 12. Solid-State Relay Connections

### Open Collector Output Connections

Open collector output 1 and 2 connections are made to terminals labeled OC1 and OC2 on Figure 4, page 22. Connect the alarm or pulse input device as shown below.

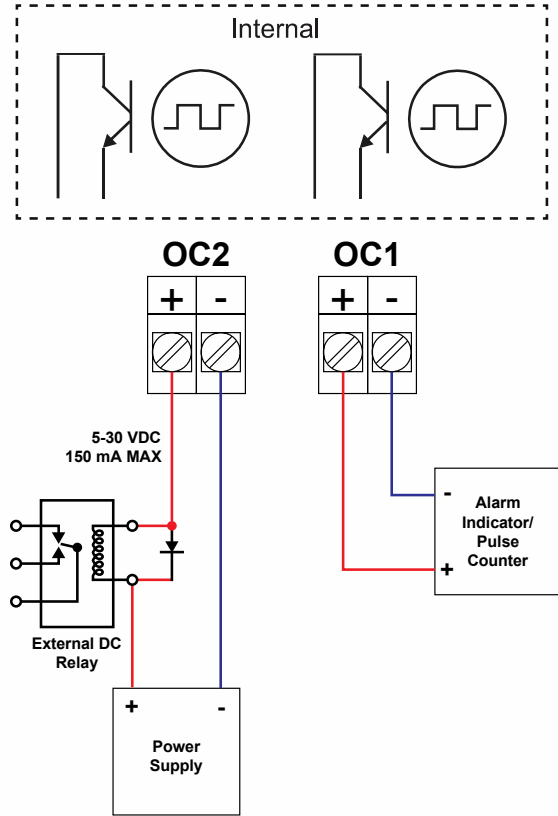

Figure 13. Open Collector Output Connections

## Setup and Programming

The meter is factory calibrated prior to shipment to display 0.00 to 100.00, which corresponds to the 4-20 mA input. The calibration equipment is traceable to NIST standards.

### Overview

There are no jumpers to set; setup and programming is done through the CapTouch buttons or the free MeterView XL PC-based software.



The meter may be powered via the micro-USB connection located on the display module for the purpose of programming only. The backlight will not work while the meter is powered via the USB connection.

### CapTouch Buttons

The PD6928 is equipped with four capacitive sensors that operate as through-glass buttons so that it can be programmed and operated without removing the cover (and exposing the electronics) in a hazardous area.



These buttons can be turned off for security by selecting the *Off* setting on the switch located on the side of the display module, close to the Menu button.

To actuate a button, press one finger to the window directly over the marked button area. When the cover is removed, the CapTouch buttons can be used after the meter completes a self-calibrating routine (hand symbol  flashes). The sensors are disabled when more than one button is pressed, and they will automatically re-enable after a few seconds (hand symbol  off).

### CapTouch Buttons Delay

The CapTouch have two modes of operation: *Normal* and *Delayed*. Use the Delayed mode to prevent accidental trigger of the buttons. In the Delayed mode, the buttons enter into a low sensitivity state (sleep) and they ignore quick button presses after 20 seconds of inactivity. To wake up the buttons, press and hold any button for more than 2 seconds, the buttons respond normally.

### Turning Off CapTouch Buttons

The CapTouch buttons can be turned off for security by moving the slide switch located on the display module to the *Off* position.



### CapTouch Button Tips & Troubleshooting

The CapTouch buttons are designed to work under any lighting condition and to protect against false triggering. If the CapTouch buttons are not needed during operation, they can be turned off (slide switch to *Off*).

- To remove cover with power applied (safe area only) or to clean the window, place your hand over the buttons; this will temporarily disable the CapTouch buttons to prevent inadvertent use.
- Keep the window clean.
- Tighten the cover securely.
- Use a password to prevent tampering.

#### IMPORTANT

- CapTouch buttons will not work if two or more buttons are detected as being pressed simultaneously. Be careful to avoid triggering multiple buttons or reaching across one button location to press another.

## MeterView XL Programming Software



The fastest and easiest way to program the meter is using the free MeterView XL programming software. This software greatly simplifies the programming process and allows the user to save configuration files for later use.

The meter connects to the PC via a provided micro-USB cable and is powered by the USB connection, so no additional power is needed during programming.

To download the latest MeterView XL programming software and manual, visit [predig.com/meterviewxl](http://predig.com/meterviewxl).

### **WARNING**

- The meter should only be connected to a computer while it is located in a safe area.

### **CAUTION**

- Care should be exercised to avoid ground loops when connecting the USB to an active loop (e.g. power supply, transmitter, loop-powered meter, etc.). It is recommended to connect the (mA+) terminal of the meter to the (-) terminal of a two-wire transmitter and the (mA-) to the (+) of the next device in the loop or to the (-) terminal of the power supply.



## CapTouch Buttons and Status Indicators

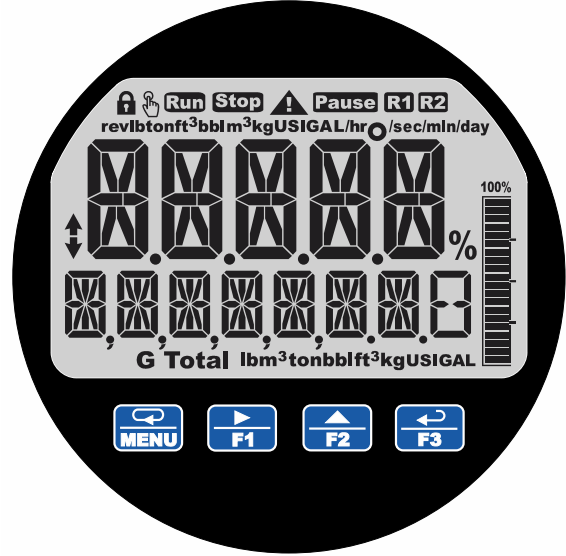

### Buttons

Button	Description
	Menu
	Right Arrow/F1
	Up Arrow/F2
	Enter/F3

1. Press the **Menu** button to enter or exit the Programming Mode at any time.
2. Press or hold the **Right-Arrow** button to scroll forward through the menus, select digits during numeric programming, select characters during text programming, or decrement the value of a digit or character selected with the **Up-Arrow** button.
3. Press and hold the **Right-Arrow** button to zero or clear digits/characters while in data-entry mode.
4. Press or hold the **Up-Arrow** button to scroll backwards through the menus or to increment the value of a digit or character.
5. Press the **Enter** button to access a menu or to accept a setting or programmed digit/character value.

### CAUTION

- Avoid touching more than one button at a time, otherwise the buttons become unresponsive and enter into a self-calibrating routine. This is indicated by the flashing hand symbol

### Indicators

Indicator	State	Description
	Steady	Process trend arrows
	Flashing	Alarm Indicator
	Steady	Password protected
<b>R1</b>	Steady	Solid-state relay 1
<b>R2</b>	Steady	Solid-state relay 2
	Flashing	CapTouch buttons self-calibrating (wait)
	Steady	PV Bargraph
	Flashing	Alarm condition: Bargraph segment flashes on alarm
<b>Total</b>	Steady	Displaying Total
<b>G Total</b>	Steady	Displaying Grand Total
<b>Run</b>	Steady	Batch is running
	Flashing	Automatic batch control: Batch paused or start delayed
<b>Stop</b>	Steady	Batch is stopped
<b>Pause</b>	Steady	Batch is paused

### Units

Display	Units
Top	rev, lb, ton, ft <sup>3</sup> , bbl, m <sup>3</sup> , kg, US GAL, IGAL, GAL, GAL/hr, GAL/sec, GAL/min, GAL/day, ° (degree), % (percent)
Bottom	lb, m <sup>3</sup> , ton, bbl, ft <sup>3</sup> kg, US GAL, IGAL, GAL

## Display Functions & Messages

The meter displays various functions and messages during setup, programming, and operation. The following table shows the main menu functions and messages in the order they appear in the menu.

Display Functions & Messages	
Parameter	Action/Setting Description
INPUT	Program the meter 4-20 mA input
SCALE RATE	Scale the rate input
UNITS	Select the display units
/SECOND	Units per second
/MINUTE	Units per minute
/HOUR	Units per hour
/DAY	Units per day
GAL/(T)	Gallons per time unit (T)
L/(T)	Liters per time unit (T)
IGAL/(T)	Imperial gallons per time unit (T)
M <sup>3</sup> /(T)	Cubic meters per time unit (T)
BARL/(T)	Barrels per time unit (T)
BUSH/(T)	Bushels per time unit (T)
CUB YD/(T)	Cubic Yards per time unit (T)
CUB FEET/(T)	Cubic Feet per time unit (T)
CUB IN/(T)	Cubic Inches per time unit (T)
L. BARL/(T)	Liquid barrels per time unit (T)
BEER BARL/(T)	Beer barrels per time unit (T)
HECTOL/(T)	Hectoliter per time unit (T)
AF/(T)	Acre-Foot per time unit (T)
CUSTOM/(T)	Custom unit per time unit (T)
INPUT 1	Program input 1 value
INP 1	Enter the input 1 value
DISP 1	Program display 1 value
DSP 1	Enter the display 1 value
INPUT 2	Program input 2 value (up to 32 points)
INP 2	Enter the input 2 value
DISP 2	Program display 2 value (up to 32 points)
DSP 2	Enter the display 2 value
SAVE?	Press Enter to save programmed units, input, and display values. Press Menu to cancel.
OUTPUT	Program the meter's available outputs
OPEN COLLECTR	Program the meter's open collector outputs
OUTPUT 1	Open collector 1 setup
OUTPUT2	Open collector 2 setup
DISABLE	Disable the open collector
PULSE	Program the open collector for pulse output

Display Functions & Messages	
Parameter	Action/Setting Description
ALARM	Program the open collector for alarm output
TIMER	Program the open collector as a timer
TOT RST	Program the open collector for total reset
STOPWATCH	Program the open collector to turn on while the stopwatch is running
MESSAGE	Select ON to display a message when open collector is on
RELAY	Program the meter's relay outputs
OUTPUT 1	Relay 1 setup
OUTPUT2	Relay 2 setup
DISABLE	Disable the relay
ALARM	Program relay for alarm functionality
SAMPLE	Program relay for sample functionality
TIMER	Program relay as a timer
BATCH	Program the relay for batch control functionality
STOPWATCH	Program relay to turn on while the stopwatch is running
MESSAGE	Select ON to display a message when relay is on
RELAY INFO	View relay runtime and cycle count
4-20 mA	Program the meter's 4-20 mA output
RATE	Transmit a value based on the rate display
TOTAL	Transmit a value based on the total display
RETRANS	Retransmit the 4-20 mA input signal
DISABLE	Disable the 4-20 mA output
CONTROL	Program manual or automatic operation for the outputs
OC 1	Open collector 1
OC2	Open collector 2
RELAY 1	Relay 1
RELAY2	Relay 2
4-20 mA	4-20 mA output
AUTO	Set selected output to automatic operation
MANUAL	Manually control selected output operation
ADVANCE	Program the meter's advanced features
RATE	Advanced 4-20 mA rate input programming
FUNCTION	Select linear, square root, or programmable exponent function

Display Functions & Messages	
Parameter	Action/Setting Description
LINEAR	Set meter for linear function and select number of linearization points
SQROOT	Set meter for square root extraction
EXPONENT	Set meter for programmable exponent and enter exponent value
SCALECAL	Scale or calibrate the mA input
SCALE RATE	Scale the rate 4-20 mA input
CAL RATE	Calibrate the rate 4-20 mA input
TOTAL	Advanced total programming
COUNT	Program the totalizer functionality
LIMIT	Set the number of digits used for the total
8-DIGIT	Eight digits max (99,999,999)
13-DIGIT	Thirteen digits max (9,999,999,999,999) Requires top and bottom display to display entire number, total will roll over to zero when it exceeds the limit.
INITIAL	Set the total to start at a specific number
RESET	Enable or disable the ability to reset the total
ENABLE	Enable total reset (default)
DISABLE	Disable total reset
GTOTAL	Advanced grand total programming
COUNT	Program the totalizer functionality
LIMIT	Set the number of digits used for the total
8-DIGIT	Eight digits max (99,999,999)
13-DIGIT	Thirteen digits max (9,999,999,999,999) Requires top and bottom display to display entire number, total will roll over to zero when it exceeds the limit.
INITIAL	Set the total to start at a specific number
RESET	Enable or disable the ability to reset the grand total
ENABLE	Enable grand total reset (default)
DISABLE	Disable grand total reset
PERMLOCK	Set grand total as non-resettable
CUTOFF	Set low-flow cutoff
DISABLE	Disable low-flow cutoff
ENABLE	Enable low-flow cutoff
FILTER	Set noise filter value
10 SEC	1 second
20 SEC	2 seconds
40 SEC	4 seconds
80 SEC	8 seconds

Display Functions & Messages	
Parameter	Action/Setting Description
160 SEC	16 seconds
OFF	Turn filter off
BYPASS	Set filter bypass (0.0 to 99.9% FS)
PASSWRD	Set a password for the meter
MAIN	Program the main meter password
TOTAL	Program the total reset password
GTOTAL	Program the grand total reset password
USER	Assign function keys / digital input
F 1	Assign F1 function key
F 2	Assign F2 function key
F 3	Assign F3 function key
DI	Assign digital input
DISP FN	Set the function key or digital input to display a value
DISPLAY	Cycle max, min, rate, total, and grand total
DISP RATE	Display the rate
DISP TOTAL	Display the total
DISP GT	Display the grand total
PCTRATE	Display the rate's percentage of max (20 mA)
DISP UNITS	Display the rate, total, and grand total units
DISP TAG	Display the tags
DISP MIN	Display the minimum rate value
DISP MAX	Display the maximum rate value
MIN MAX	Display the minimum and maximum rate value
DISP mA IN	Display the current mA input value
DISP mA OUT	Display the current mA output value
MENU FN	Set the function key or digital input to access a menu
REL Y INFO	Go to relay information menu (INFO)
MAN CTRL	Go to output control menu (CTRL)
TIMR OC 1	Open collector 1 timer
TIMR OC 2	Open collector 2 timer
TIMER R 1	Relay 1 timer
TIMER R 2	Relay 2 timer
TIMER FN	Set the function key or digital input to start or stop a timer
START ALL	Start all timers
STOP ALL	Stop all timers
SSTP ALL	Start or stop all timers
OC 1	Start/stop open collector 1 timer
OC 2	Start/stop open collector 2 timer
RLY 1	Start/stop relay 1 timer

Display Functions & Messages	
Parameter	Action/Setting Description
RLY2	Start/stop relay 2 timer
START	Start the selected timer output
STOP	Stop the selected timer output
STR--STP	Start or stop the selected timer output
BATCHFN	Set the function key or digital input to batch control
START	Start a batch
STOP	Stop a batch
STR--STP	Start or stop a batch
PRESET	Preset batch amount
ALARMFN	Set the function key or digital input to acknowledge an alarm or access set points
ACK	Acknowledge all active alarms
SETPPOINT	Access all output set points
SETPTOC1	Access open collector 1 set point
SETPTOC2	Access open collector 2 set point
SETPTR1	Access relay 1 set point
SETPTR2	Access relay 2 set point
SWATCHFN	Set the function key or digital input to activate stopwatch
START	Start the stopwatch
STOP	Pause/Stop the stopwatch
STR--STP	Start or stop the stopwatch
HOLD FN	Set the function key or digital input to hold an output
HOLD OUT	Hold all outputs while F1-F3 or DI are active (pressed or on)
UNHOLD	Displayed when hold all outputs key is released
HL UNHLD	Displayed when hold all outputs key is released
OC 1+2	Hold/un-hold open collector outputs
RLY 1+2	Hold/un-hold relay outputs
mROUT	Hold/un-hold 4-20 mA output
HOLD	Hold selected output
HL UNHLD	Hold or un-hold selected output
DISABLE	Disable function key or digital input
RST FN	Set the function key or digital input to reset a value
RESET	Reset min, max, or max/min rate value
R MINMAX	Reset max and min rate value
RST T	Reset the total
RST GT	Reset the grand total
RST TGT	Reset the total and grand total
HINT	Display hint text on key press and execute action on next key press
OFF	Turn the hint function off

Display Functions & Messages	
Parameter	Action/Setting Description
ON	Turn the hint function on
SYSTEM	Program system settings
ADJCAL	Calibrate the analog output
DEFAULT	Load factory defaults
TOTAL	Enable or disable the totalizer
ENABLE	Enable the totalizer (Default)
DISABLE	Disable the totalizer
BACKLITE	Enable/disable display backlight
ENABLE	Enable the backlight (default)
DISABLE	Disable the backlight
CAPTUCH	Select CapTouch buttons mode
NORMAL	CapTouch normal (default)
DELAYED	CapTouch delayed
INFO	View meter software version and model; change the identifier tag
SFT	The software ID number
VER	The software version
MODEL	The meter model number
IDTAG	The meter identifier tag Press <i>Enter</i> to edit tag
ICAL	Internal calibration used for scaling
DISPLAY	Program the meter's display
UNITS	Change the display units within the selected unit class
RATE	Select the rate units
TOTAL	Select the total units
UMULT	Select the total units multiplier X1, 100 h, 1000 k, 1.0E^6 M
GTOTAL	Select the grand total units
UMULT	Select the grand total multiplier X1, 100 h, 1000 k, 1.0E^6 M
DECP	Change the decimal point location
RATE	Program the rate decimal point
TOTAL	Program the total decimal point
GTOTAL	Program the grand total decimal point
COMMA	Enable or disable the use of a comma on the bottom display
ENABLE	Enable comma (default)
DISABLE	Disable comma
BARGRAPH	Turn off or change the bargraph
RATE PCL	Set the bargraph to display the rate percentage of full scale
RATE	Set the bargraph to display the rate percentage of a user-selected range
TOTAL	Set the bargraph to display the total percentage of a user-selected range
OFF	Turn the bargraph feature off

Display Functions & Messages	
Parameter	Action/Setting Description
TOP	Select what to display on the top display
RATE	Display the rate
RATE+U	Display the rate and its units alternating
TOTAL	Display the total
TOTAL+U	Display the total and its units alternating
GTOTAL	Display the grand total
TAG	Display the tag
UNITS	Display the units
PRESET	Display the preset value
STPWATCH	Display the stopwatch
TIMR OC 1	Display open collector 1 timer
TIMR OC 2	Display open collector 2 timer
TIMER R 1	Display relay 1 timer
TIMER R 2	Display relay 2 timer
MIN	Display minimum value
MAX	Display maximum value
MIN MAX	Display alternating min and max
OFF	Disable the top display
BOTTOM	Select what to display on the bottom display
TOTAL	Display the total
TOTAL+U	Display the total and its units alternating
TOT+TAG	Display the total and its tag alternating
T+U+RU	Display the total, its units, and the rate units alternating
GTOTAL	Display the grand total
GT+UNITS	Display the grand total and its units alternating
GT+TAG	Display the grand total and its tag alternating
GT+U+RU	Display the grand total, units, and rate units alternating
RATE	Display the rate
RATE+TU	Display the rate and the total's units alternating
RATE+U	Display the rate and its units alternating
RATE+TAG	Display the rate and its tag alternating
R UNITS	Display the rate units
T UNITS	Display the total units
TAG	Display the tag
UNITS	Display the units
PRESET	Display the preset value
STPWATCH	Display the stopwatch
TIMR OC 1	Display open collector 1 timer

Display Functions & Messages	
Parameter	Action/Setting Description
TIMR OC 2	Display open collector 2 timer
TIMER R 1	Display relay 1 timer
TIMER R 2	Display relay 2 timer
TAG+RU	Display the tag and rate units alternating
TAG+TU	Display the tag and total units alternating
OFF	Disable the bottom display
R PCT	Display the rate's percentage of full scale
mA IN	Display the current mA input value
mA OUT	Display the current mA output value



## Main Menu

The main menu consists of all the meter's programmable functions: *Input*, *Output*, *Advanced*, and *Display*.

- Press **Menu** button to enter *Programming Mode* then press the **Right-Arrow** button to move forward through the menu and the **Up-Arrow** button to move back.
- Press **Menu** at any time to go back one level or press & hold to exit and return to *Run Mode*. Changes made to settings prior to pressing **Enter** are not saved.
- Changes to the settings are saved to memory only after pressing **Enter/F3** to confirm the setting or pressing **Enter/F3** at the **SAVE ?** screen when available.

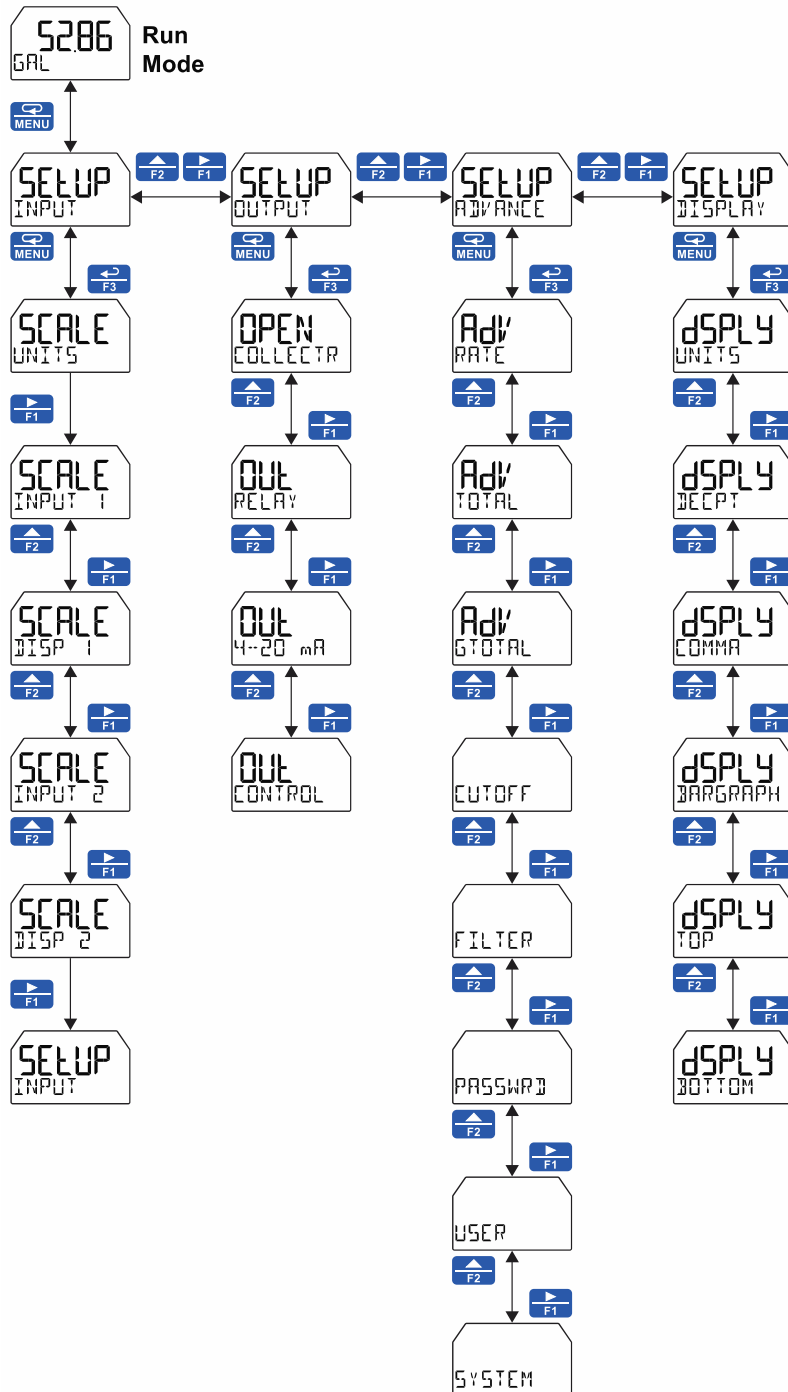

**Note:** The navigation returns to the top

### Setting Numeric Values

The numeric values are set using the **Right** and **Up-Arrow** buttons.

1. Press **Right-Arrow** to select next digit and **Up-Arrow** to increment digit value. The selected digit will flash.
2. Press and hold **Up-Arrow** to auto-increment the display value. If you have made a mistake or would like to enter a new value, select the left-most digit, and press and hold the **Right-Arrow** button until all digits reset to zero.
3. Press the **Enter** button at any time to accept a setting or **Menu** button to exit without saving changes.

**Note:** the underscore in the graphic below is provided to show which digit would be flashing.

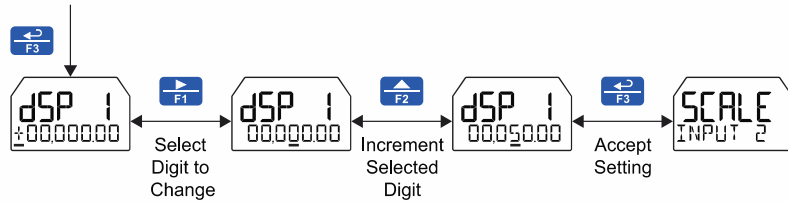

**Note:** Selected digit flashes. Flashing digit demonstrated using underscore.  
Example: 0005000

## Scaling the 4-20 mA Input (INPUT)

It is **very important** to read the following information before proceeding to program the meter:

- The meter is factory calibrated prior to shipment to display 0.00 to 100.00 gal/sec, which corresponds to the 4-20 mA input. The calibration equipment is traceable to NIST standards.
- A calibrated signal source is not needed to scale the meter.

Enter the *Input* menu to scale the meter to display the 4-20 mA input. The input can accept any signal from 4-20 mA.

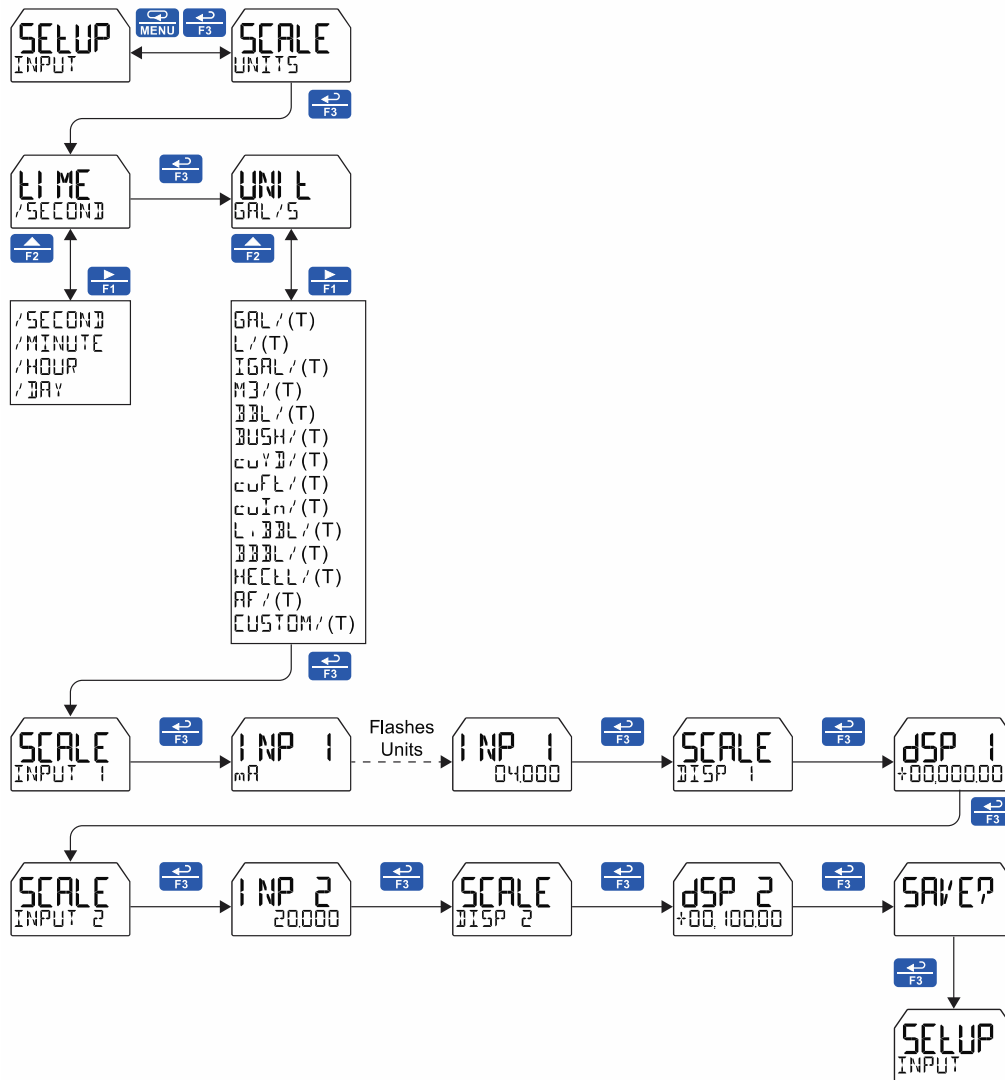

**IMPORTANT**

- **Reverse Scaling**  
The meter can be scaled so that 4 mA represents the high end of the process value range being measured by the transmitter and 20 mA represents the low end of the process value range.

### Available Engineering Units

The meter has preprogrammed rate and time base units. The following are the available units to choose from:

Rate Time Bases (TIME)	
/SECOND	Units per second
/MINUTE	Units per minute
/HOUR	Units per hour
/DAY	Units per day

Rate Units (RATE)	
GAL/(T)	Gallons per time unit (T)
L/(T)	Liters per time unit (T)
IGAL/(T)	Imperial gallons per time unit (T)
M3/(T)	Cubic meters per time unit (T)
BARREL/(T)	Barrels per time unit (T)
BUSH/(T)	Bushels per time unit (T)
CUYD/(T)	Cubic Yards per time unit (T)
CUFT/(T)	Cubic Feet per time unit (T)
CUIN/(T)	Cubic Inches per time unit (T)
L.BARREL/(T)	Liquid barrels per time unit (T)
BBBL/(T)	Beer barrels per time unit (T)
HECLL/(T)	Hectoliter per time unit (T)
AF/(T)	Acre-Foot per time unit (T)
CUSTOM/	Custom unit per time unit (T)

#### IMPORTANT

- For access to additional predefined units, you must disable the totalizer. See *Disabling the Totalizer (TOTAL)* on page 67.

### Additional Unit Classes and Units

The meter has six available preprogrammed unit classes, if the total is not enabled: *volume, height, temperature, pressure, weight, and rate*. Each unit class has the following available units to choose from:

Volume Units (VOLUME)	
GAL	Gallons
L	Liters
IGAL	Imperial Gallons
M3	Cubic Meters
BARREL	Barrels
BUSH	Bushels
CUYD	Cubic Yards
CUFT	Cubic Feet
CUIN	Cubic Inches
L.BARREL	Liquid barrels
BBBL	Beer barrels
HECLL	Hectoliter
AF	Acre-Foot
CUSTOM	Custom Unit

Height Units (HEIGHT)	
INCH	Inches
FEET	Feet
FT-IN	Feet & Inches
YARD	Yards
CM	Centimeters
M	Meters
CUSTOM	Custom unit

Temperature Units (TEMP)	
°F	Degrees Fahrenheit
°C	Degrees Celsius
K	Kelvin
°RA	Degrees Rankine

Pressure Units (PRESSURE)	
PSI	Pounds per square inch
INHG	Inches of mercury
INH2O	Inches of water
mmHG	Millimeters of mercury
KG/CM2	Kilograms per square centimeter
KG/M2	Kilograms per square meter
mBAR	Millibar
BAR	Bar
PA	Pascal
HPA	Hectopascal
KPA	Kilopascal
MPA	Megapascal
CUSTOM	Custom unit

Weight Units (WEIGHT)	
Gm	Grams
KG	Kilograms
TONNE	Tonnes (metric)
oz	Ounces
lb	Pounds
TON	Tons
CUSTOM	Custom unit

### Setting Custom Units (CUSTOM)

When the desired unit class or unit of measure within a class is not available, a custom unit may be programmed. Select the CUSTOM menu (or CUSTOM unit within a unit class) to enter a custom unit name.

Text values are set using the **Right** and **Up-Arrow** buttons. Press **Right-Arrow** to select next character and **Up-Arrow** to increment character value. The selected character will flash. Press and hold the **Up** or **Right-Arrow** buttons to auto-increment or decrement the character. Press **Enter** to accept the character.

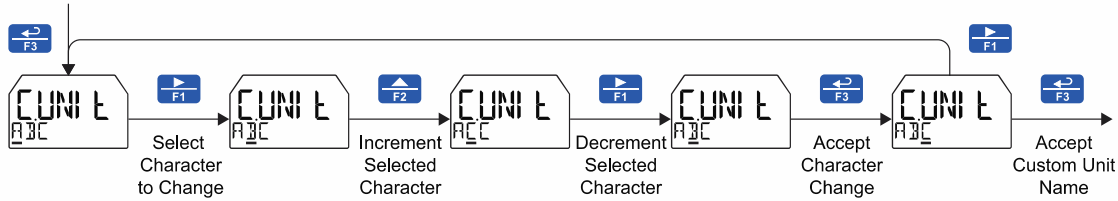

**Notes:**

- Press and hold the **Right-Arrow** while no character is being edited to erase all characters to the right of the flashing character
- Press and hold **Up** or **Right-Arrow** to auto-increment or decrement a selected character.
- All text values, including tags and alarm messages, are set in a similar fashion.

### Setting the Display Features (DISPLAY)

The meter's display functions may be programmed using the Display menu. This menu consists of the following submenus: *Units, Decimal Point, Comma, Bargraph, Top, and Bottom.*

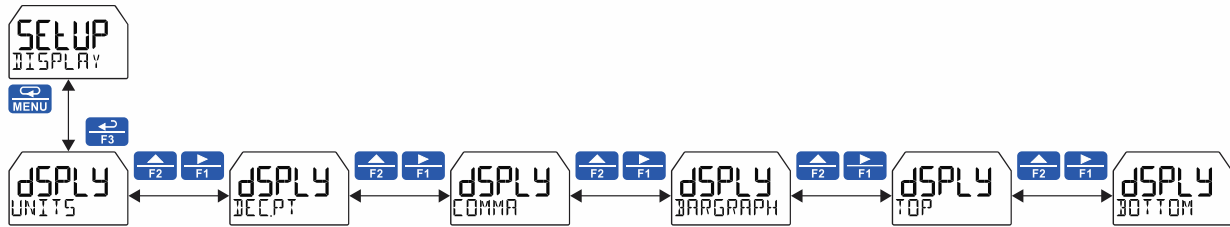

### Changing the Engineering Units (UNITS)

It is possible to change the engineering units within the selected unit class without the need to re-scale the meter. When selecting a new unit from within the DISPLAY menu (e.g. changing from gallons (GAL) to liters (L)), the meter will automatically convert the display values to display the new unit. Enter the UNITS menu, select a new unit of measure from the list of predefined units, and press the **Enter** button. If entering a custom unit (CUSTOM), a custom conversion factor will need to be entered.

### Changing the Decimal Point (DECP)

The decimal point may be set with up to seven decimal places or with no decimal point at all.

Pressing the **Right-Arrow** moves the decimal point one place to the right until no decimal point is displayed, and then it moves to the left most position. Pressing the **Up-Arrow** moves the decimal point one place to the left.

If the dual-scale level feature is selected, the decimal point selections for PV1 & PV2 are enabled.

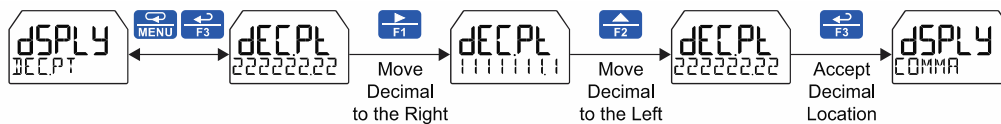

### Enabling or Disabling Commas on the Bottom Display (COMMA)

The bottom display is set to show a comma separating the thousands and millions place by default if a numeric value is being displayed. This feature can be disabled or enabled using the *Comma* menu.

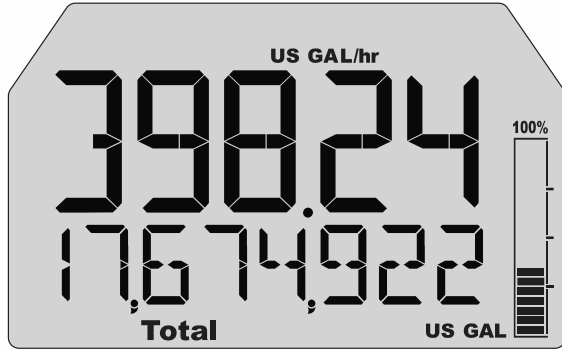

### Display Capabilities Optimization (TOP and BOTTOM)

#### Display Configuration Examples

The meter's dual-line display can be setup in multiple ways to provide an extremely informative view of the process variable being monitored. The following graphics show typical configurations:

**Top Display:** Toggle Flow Rate and Rate Units  
**Bottom Display:** Toggle Total Flow and Total Units

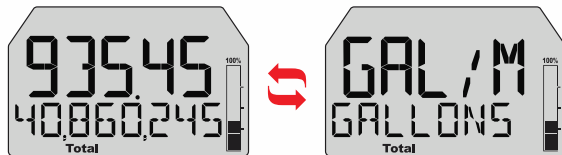

**Note:** To display units as GALLONS, select custom units and enter the desired text.

**Top Display:** Flow Rate  
**Bottom Display:** Toggling Between Units and Tag

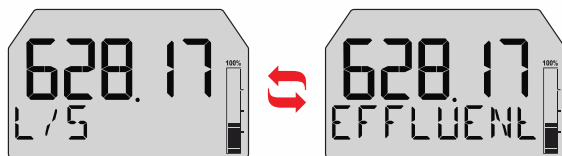

### Dual-Scale Mode:

**Top Display:** Toggle Rate and GPM Units

**Bottom Display:** Toggle Rate and CFM Units

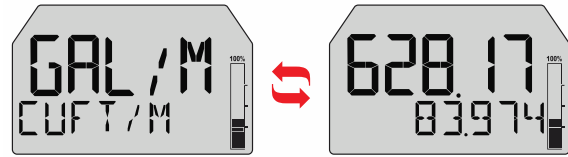

**Top Display:** Maximum Value  
**Bottom Display:** Process Value

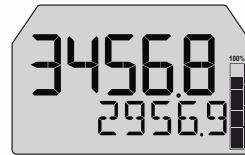

### Using 13 Digits to Display Total

The top and bottom displays can be set up to display a 13-digit total.

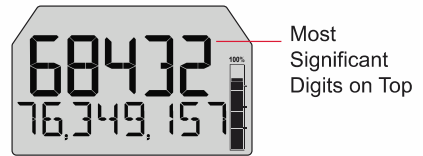

**Note:** The number above should be read as 6,843,276,349,157

### Configuring the Display (TOP and BOTTOM)

The display is configured using the TOP and BOTTOM menus in the DISPLAY menu.

If the totalizer is disabled and PV2 is enabled, additional options will be available for displaying the second PV on the bottom display.

The top display (TOP) can display:

- Rate
- Rate and its units alternating
- Total
- Total and its units alternating
- Grand Total
- Tag
- Units
- Preset batch value
- Stopwatch
- Open Collector 1 or 2 Timer
- Relay 1 or 2 Timer
- Minimum Value, Maximum Value, or Both
- Off (Blank)

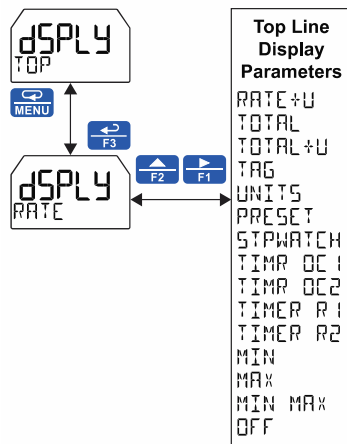

The bottom display (BOTTOM) can display:

- Total (with units or tag alternating)
- Total, its units, and the rate units alternating
- Grand total (with units or tag alternating)
- Grand total, units, and rate units alternating
- Rate (with units or tag alternating)
- Rate and the total's units alternating
- Rate or total units
- Tag
- Units
- Preset batch value
- Stopwatch
- Open Collector 1 or 2 Timer
- Relay 1 or 2 Timer
- Tag and rate units alternating
- Tag and total units alternating
- Off (Blank)
- Rate's percentage of max scale
- mA input value
- mA output value

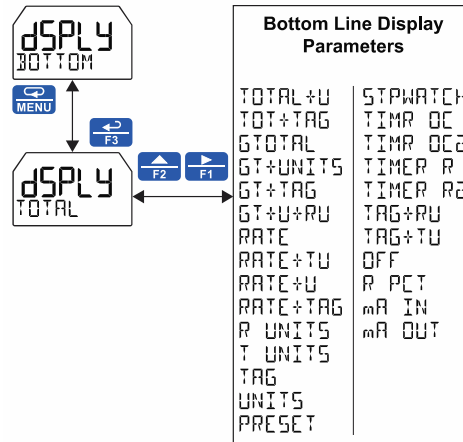

### Programming the Bargraph (BARGRAPH)

The ProtEX+ Rate/Totalizers come equipped with a bargraph display for applications where a visual representation of the rate or total's percentage of full scale is desirable. This feature can be changed to represent either rate, a percentage of the rate, total, or it can be disabled, using the *Bargraph* menu (BARGRAPH). If the bargraph is set to represent total, the total full scale will need to be set.

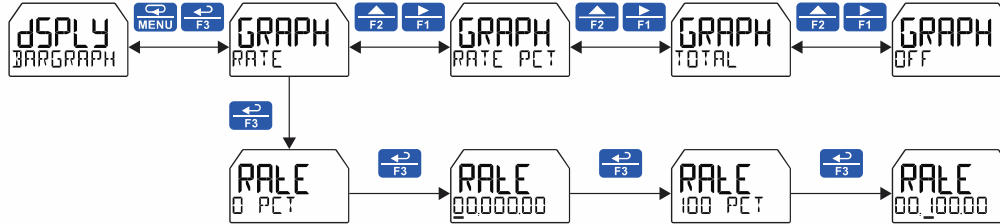

### Programming the Outputs (OUTPUT)

All models come with two open collectors. Depending on the model purchased, the meter may include two solid-state relays, and one 4-20 mA output. The *Output* menu will only show options for the available outputs. See *Ordering Information* on page 12 for details.

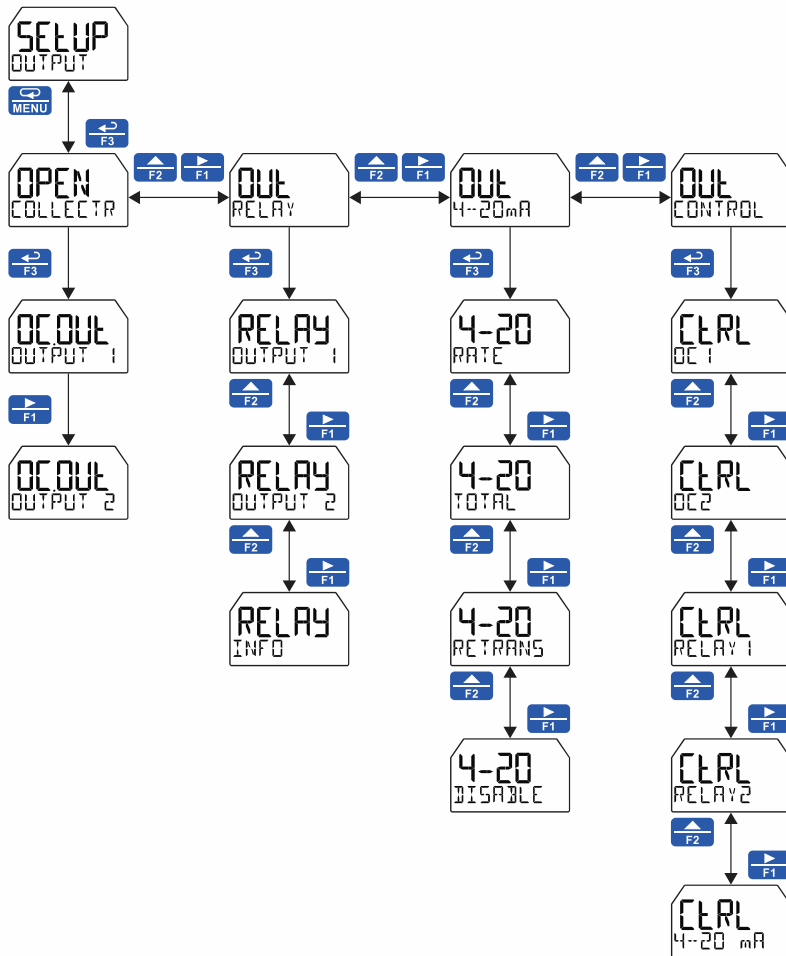



### Open Collector Outputs (OPEN COLLECTR)

The meter is equipped with two NPN open collector outputs that may be set up for pulse outputs, alarms, timed pulses, total reset, or disabled.

Pulse outputs can be set to transmit the rate, total, or grand total. Output 2 may be used to generate a quadrature output based on the other open collector output. An output test mode is also selectable to generate pulses at a constant programmable frequency.

Alarms are available based on the rate value or the digital input. The alarm status will show on the display even if the output is not wired.

A timer output (TIMER) turns the open collector on and off at the specified time intervals. The timer can be set as single-shot or continuous timer.

A total reset output generates a pulse whenever the total is reset, regardless of the reset method used. The On time is programmable between 0 and 9,999 seconds.

The stopwatch output (STPWATCH) allows the open collector to be manually activated by starting the stopwatch. The stopwatch count can be displayed on the top or bottom display.

The output may be disabled by selecting DISABLE.

The Open Collector Outputs are programmed in the following manner:

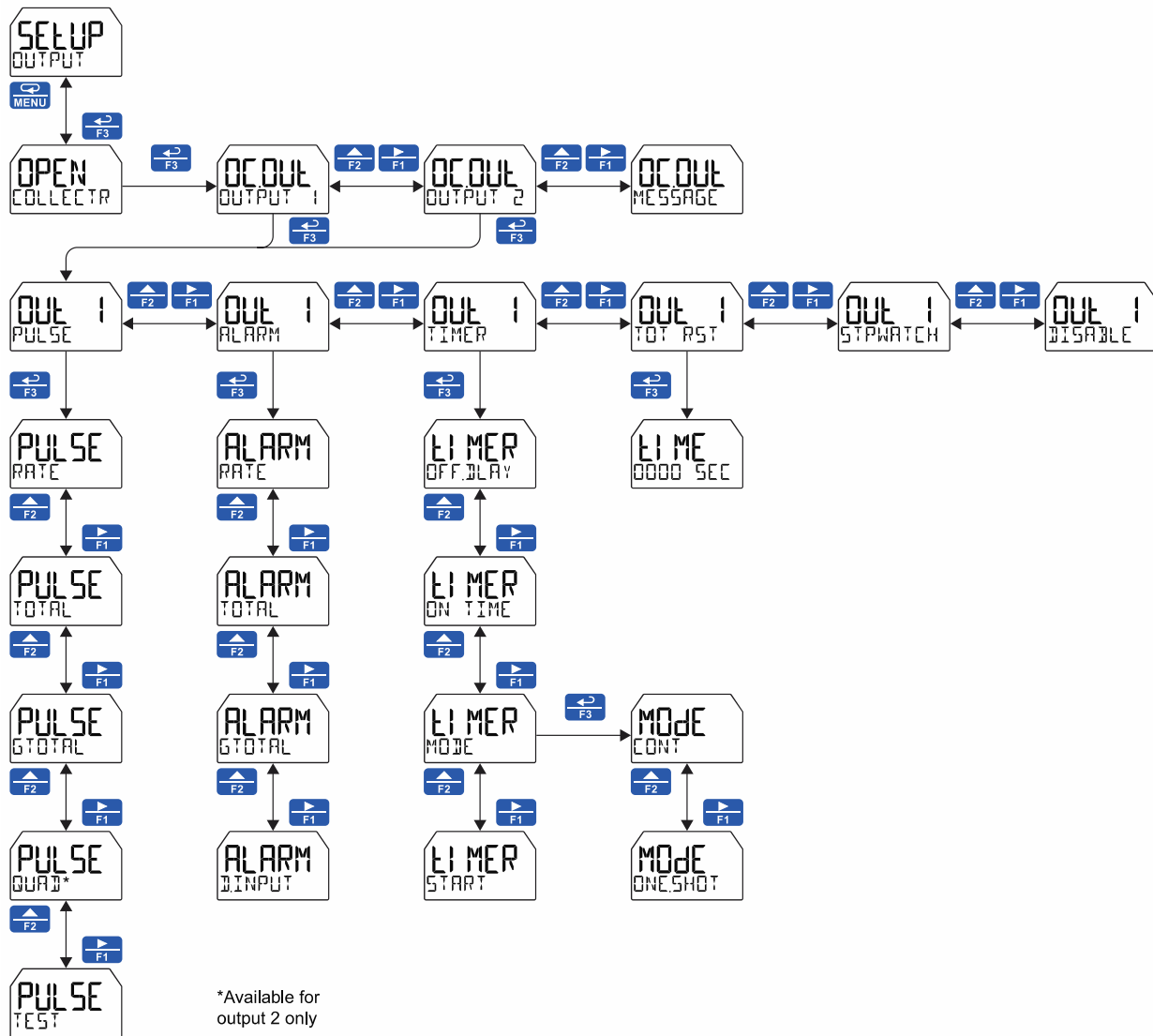

### Pulse Output (PULSE)

Pulse outputs may be assigned to output the rate, total, or grand total at a programmable factor. If the output is assigned to rate, the factor is a multiplier that determines the number of pulses generated based on the rate. For example, if the meter display shows 100 gallons/second and the factor is set to 2, the number of pulses generated per second would be 200. If the output is assigned to total or grand total, the k-factor corresponds to the number of pulses generated per unit of measure. For example, if the k-factor is 0.001 and the units are gallons, one pulse will be generated for every 1,000 gallons. The maximum frequency is 1,000 Hz.

Setting output 2 to quadrature will duplicate the other open collector output, but lag by 90 degrees out of phase. The other output should be programmed as desired for the quadrature output function and must be a pulse (PULSE) output selection. The quadrature maximum frequency for both outputs is 500 Hz.

The TEST option will output a fixed number of pulses per second based on the FREQ value entered.

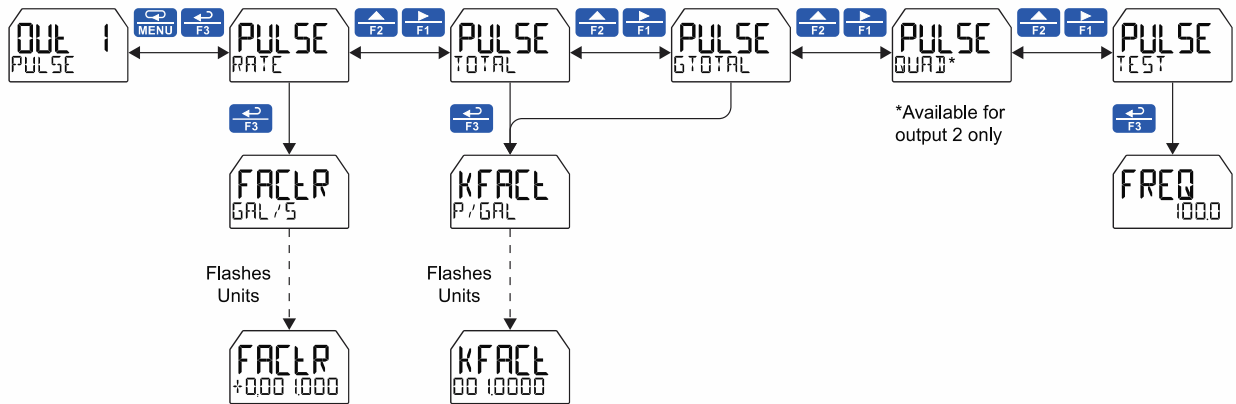

### Alarm (ALARM)

Alarm outputs may be assigned to the rate, total, grand total, or the digital input. When assigned to the rate, the alarm may be set as either a high alarm or a low alarm. Alarm actions (AUTO, AUTOMAN, LATCH, L--CLEAR) determine how and when the alarm should be reset. They operate as follows:

- **Automatic (AUTO):** Alarm will reset automatically once the alarm condition has cleared.
- **Automatic/Manual (AUTOMAN):** Alarm will reset automatically once the alarm condition has cleared but can also be reset using the **Enter** (ACK) button (or whichever function key is set to acknowledge) at any time.
- **Latching (LATCH):** Alarm must be reset manually and can be done so at any time. Press the **Enter** (ACK) button at any time to clear the alarm.
- **Latching with Reset after Clear (L--CLEAR):** Alarm must be reset manually and can only be done so after the alarm condition has cleared. Press the **Enter** (ACK) button after the alarm condition has cleared to reset the alarm.

If the alarm is set to rate, a set and reset point must be programmed. The set point is the display value at which the alarm will turn on and the reset point is the display value at which the alarm will turn off. If the set point is lower than the reset point, the alarm will be a low alarm; if the set point is higher than the reset point, the alarm will be a high alarm. The digital input alarm will trigger whenever the digital input is triggered.

For both the rate and digital input alarms, a delay before the alarm is turned on or off may be set, as well as a fail-safe feature which reverses the on/off operation of the open collectors.

Alarm states will be displayed on the meter even if no open collector output is physically connected. These may include a red LED backlight, flashing the rate value (rate alarm only), a programmable alarm message, an alarm indicator ▲, and flashing bargraph segment.

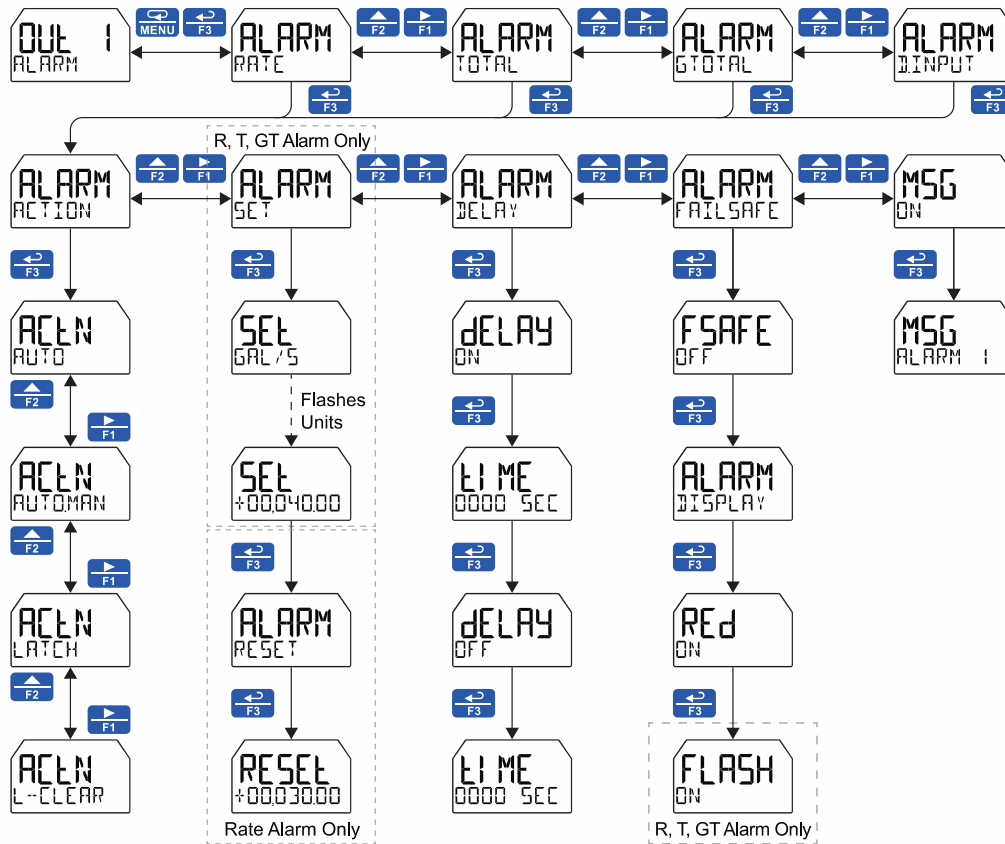

### Flashing Red Alarm (RED)

The last two lines in the preceding menu flow chart show how to program the display to turn red, flash, and display a message when an alarm occurs.



Alarm 1 is High Alarm



Alarm 2 is Low Alarm

### Timer (TIMER)

The timer output may be set to generate the timed pulse only once (ONESHOT) or continuously (CONT).

The timer output produces a constant width pulse at a constant frequency, if set as continuous timer. Program the *Off Delay* (OFF DELAY) from 1 second to 99 hours 59 minutes and 59 seconds. This is the time it takes from selecting START to turning on the output and for how long the output is off in continuous mode.

Program the *On Time* (ON TIME) for the active low pulse from 1 second to 99 hours 59 minutes and 59 seconds (pulse width). This is the period of time for which the output will remain on.

Select *Start* (START) to begin outputting the constant timed pulse.

Select *Stop* (STOP) to end outputting the constant timed pulse.

Function keys or the digital input may be assigned to start and stop timer functions (see the USER menu in the *Advanced Menu*).

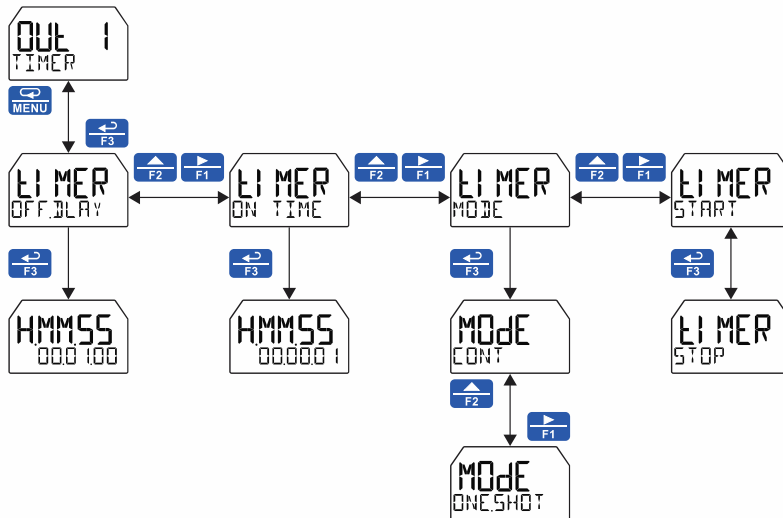

## Stopwatch (STPWATCH)

The stopwatch function may be used to manually run and control a process for a specific time interval up to 99 hrs., 59 min, and 59 seconds. The stopwatch function may be assigned to any open collector. There are three settings needed to use the function effectively.

1. Assign stopwatch to either top or bottom display
2. Assign the open collector to control the process (on/off)
3. Assign a function key or digital input to start/stop the stopwatch

### Application Example

To maintain consistency of a product, it is necessary to take and test samples at different times throughout the day. The stopwatch function is used to open and close a solenoid valve to know the exact amount of time needed to complete the desired sample. Once this is determined, the timer function can be used to automatically take a sample (batch) based on the time determined using the stopwatch function.

**Setup:** Assign the following to *Stopwatch Function*

- Bottom display  
(see pages 37 & 39 for details how to change the display)
- Relay 1  
(see pages 40 & 46 how to change Open Collector and Solid-State Relay functionality)
- F3: Start/Stop  
(see pages 65 & 66 for details on how to change the function keys)

### Procedure

- Press F3 to start the stopwatch; relay 1 turns on and the process starts running.
- Press F3 to stop the stopwatch; relay 1 turns off and the process stops.
- The bottom display indicates the time it took to complete the sample.

### Solid-State Relay Outputs (RELAY)

The meter is optionally equipped with two solid-state relays that may be set up for alarms, sample, timer, batch control, or stopwatch. Alternatively, they may be disabled.

Alarms are available based on the rate, total, grand total, or the digital input. The alarm status will show on the display even if the output is not wired.

Sample will engage the relay for a programmed period of time when either the total or the grand total have reached a programmed amount.

A timer output (TIMER) turns the relay on and off at the specified time intervals. The timer can be set as single-shot or continuous timer.

For use in batch control applications, the meter relays must be set to batch. This will enable the batch control features of the meter.

The stopwatch output (STOPWATCH) allows the relay to be manually activated by starting the stopwatch. The stopwatch count can be displayed on the top or bottom display.

The output may be disabled by selecting **DISABLE**.

#### CAUTION

- During setup, the relays do not follow the input and they will remain in the state found prior to entering the *Relay* menu.
-

Relay Menu

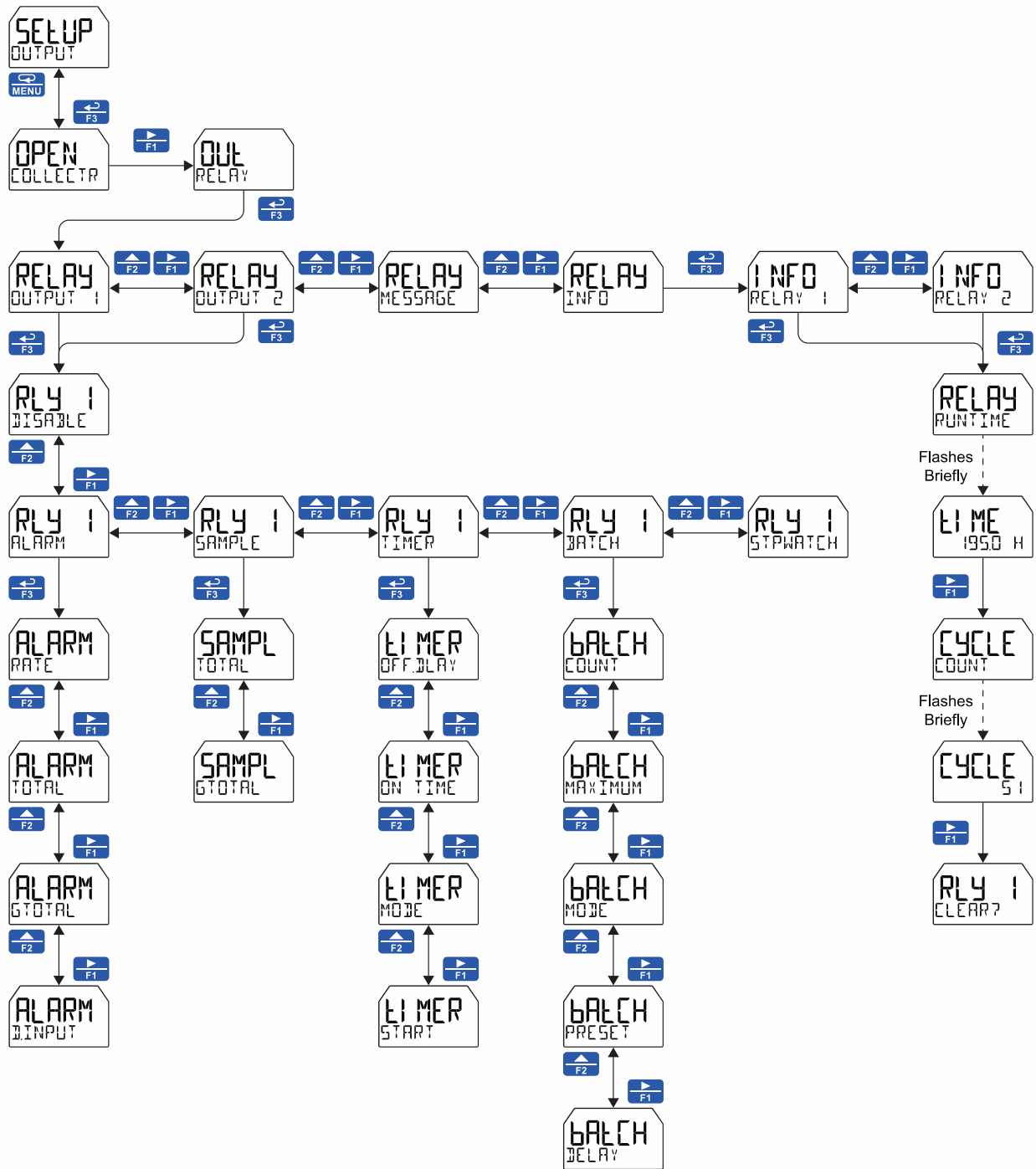

### Alarm (ALARM)

Alarm outputs may be assigned to the rate, total, grand total, or the digital input. When assigned to the rate, the alarm may be set as either a high alarm or a low alarm. Alarm actions (AUTO, AUTOMAN, LATCH, L--CLEAR) determine how and when the alarm should be reset. They operate as follows:

- **Automatic (AUTO):** Alarm will reset automatically once the alarm condition has cleared.
- **Automatic/Manual (AUTOMAN):** Alarm will reset automatically once the alarm condition has cleared but can also be reset using the **Enter** button (or whichever function key is set to acknowledge).
- **Latching (LATCH):** Alarm will **not** reset automatically even if the alarm condition has cleared. Press the **Enter** button at any time to acknowledge the alarm.
- **Latching with Reset after Clear (L--CLEAR):** Alarm must be reset manually and can only be done so after the alarm condition has cleared. Press the **Enter** (ACK) button after the alarm condition has cleared to reset the alarm.

If the alarm is set to rate, a set and reset point must be programmed. The set point is the display value at which the alarm will turn on and the reset point is the display value at which the alarm will turn off. If the set point is lower than the reset point, the alarm will be a low alarm; if the set point is higher than the reset point, the alarm will be a high alarm. If the alarm is set to total or grand total, only a set point needs to be programmed. The digital input alarm will trigger whenever the digital input is triggered.

For all alarms, a delay before the alarm is turned on or off may be set, as well as a failsafe feature which will inverse the on/off programming.

Alarm states will be displayed on the meter even if no relay output is physically connected. The alarm indicator ▲ will display as well as optional red LED backlight, flashing rate, total, or grand total value (rate, total, or grand total alarms only), and a programmable alarm message.

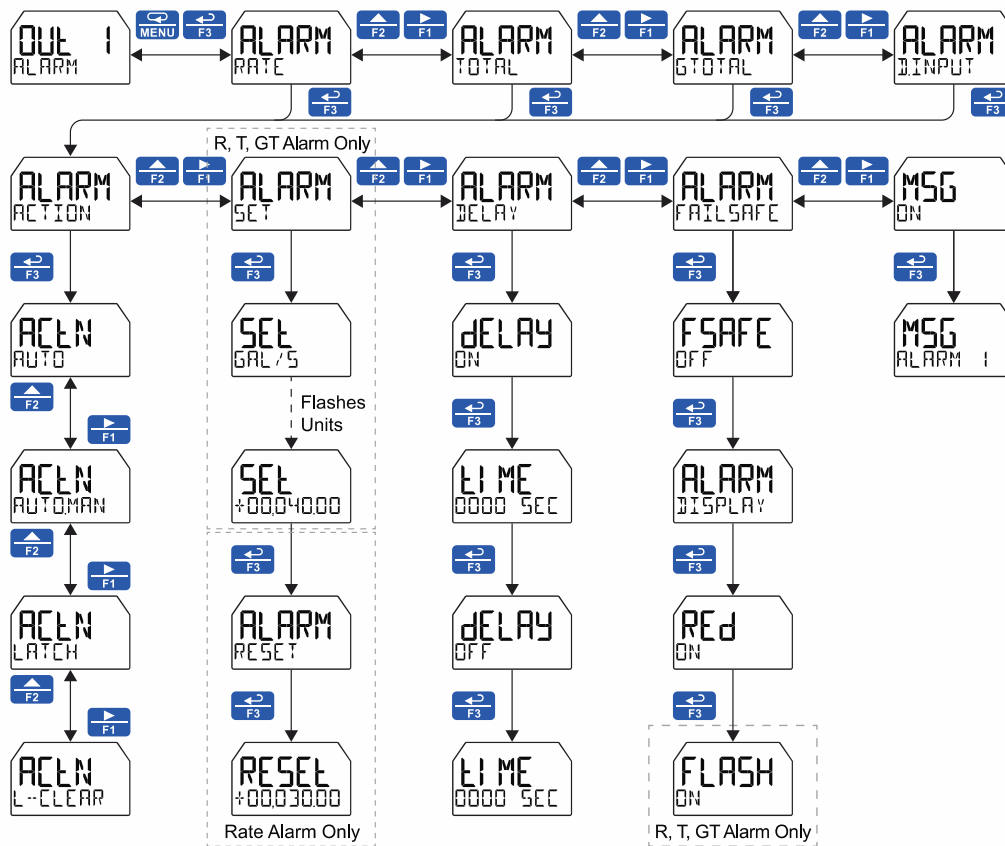



### Sample (SAMPLE)

A relay set to sample will trigger when the total or grand total value has incremented by a programmed amount. The relay can be programmed to stay on for a specified amount of time.

**For example:** if a relay is set to sample the total with a **COUNT** of 1,000 and a **TIME** of 10 seconds, the relay will engage for 10 seconds whenever the total has incremented by 1,000 (e.g. 1000, 2000, 3000).

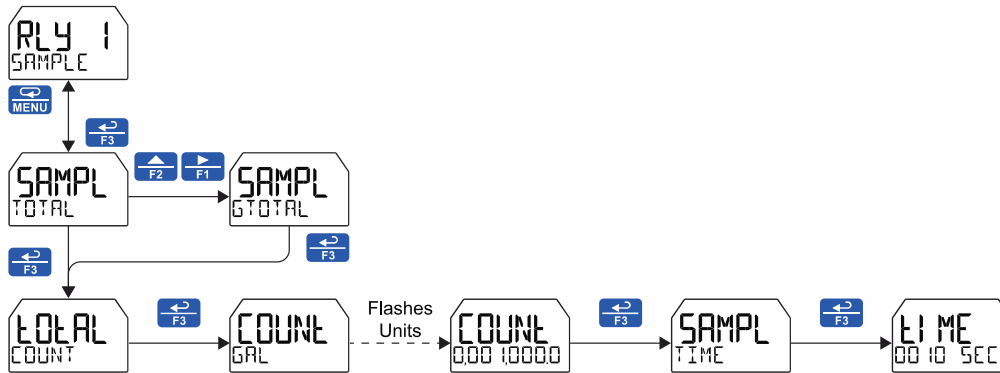

### Timer (TIMER)

The timer output may be set to generate the timed pulse only once (**ONESHOT**) or continuously (**CONT**). The timer output produces a constant width pulse at a constant frequency, if set as continuous timer.

Program the *Off Delay* (**OFF DELAY**) from 1 second to 99 hours 59 minutes and 59 seconds. This is the time it takes from selecting **START** to turning on the output and for how long the output is off in continuous mode.

Program the *On Time* (**ON TIME**) for the active low pulse from 1 second to 99 hours 59 minutes and 59 seconds (pulse width). This is the period of time for which the output will remain on.

Select *Start* (**START**) to begin outputting the constant timed pulse. Select *Stop* (**STOP**) to end outputting the constant timed pulse. Function keys or the digital input may be assigned to start and stop timer functions (see the **USER** menu in *Advanced*).

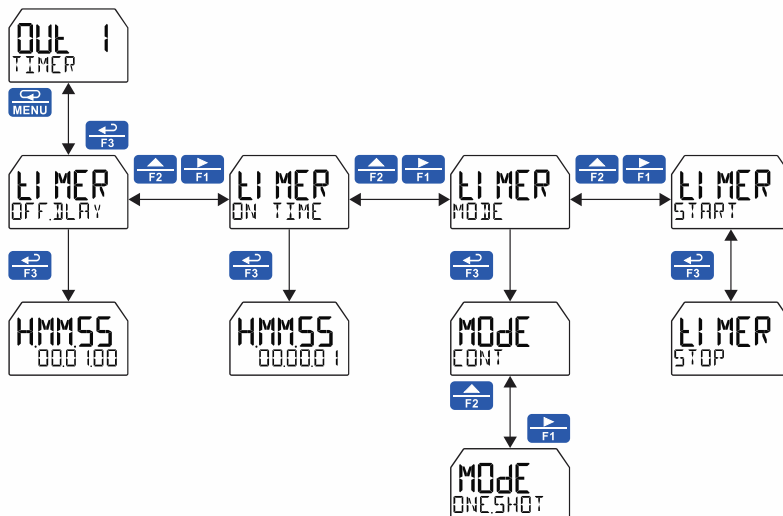

### Batch Control (BATCH)

Selecting batch control for relay 1 enables the batching features on the meter. The top display is changed to show the total and the bottom display is changed to display the preset batch amount. The function keys are changed so that F1 starts a batch, F2 opens the preset menu to allow the preset value to be changed, and F3 stops the currently running batch. Enabling batch control for relay 1 allows access to the batch menu under relay 2 (this menu does not appear by default).

#### Batch Control Relay 1

The batch total can be set to count UP or DOWN. The batch MAXIMUM is the max preset amount that can be batched. Batching can be set to either manual or automatic operation (MANUAL or AUTO). If setting batching to automatic, a delay before the next batch is started must be programmed. The PRESET amount is the value at which the batch will stop and can be programmed up to the value assigned in the MAXIMUM menu. An on and off delay may be set for batching relays.

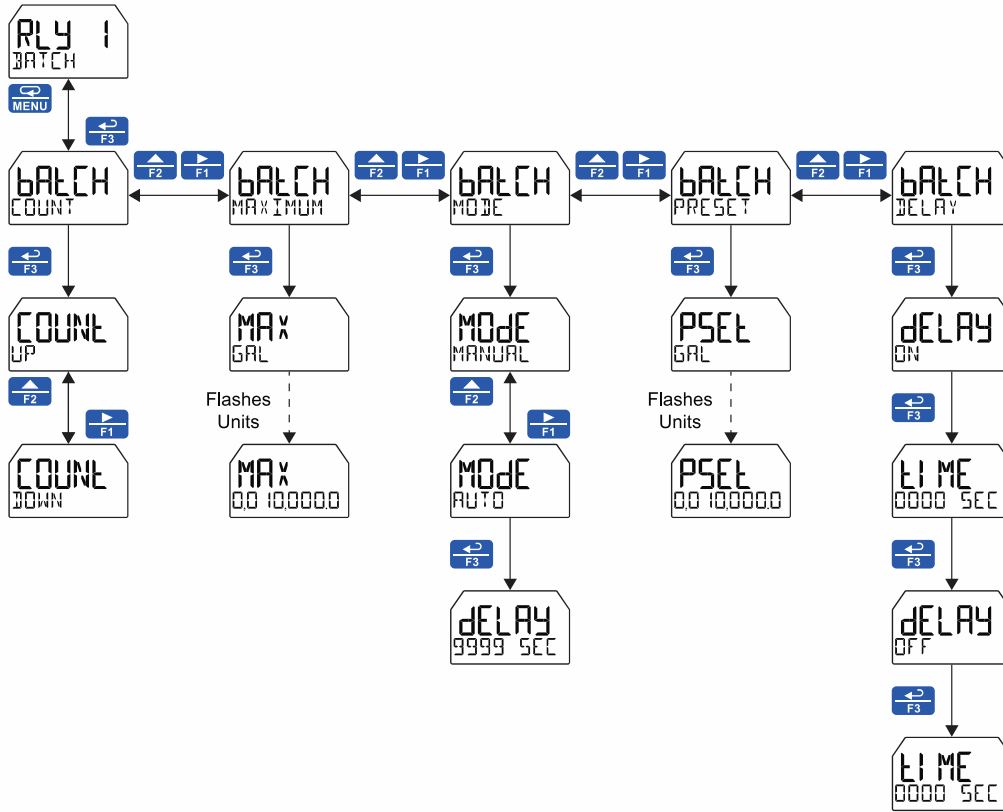

### Batch Control Relay 2

The **BATCH** option only appears under relay 2 if relay 1 has also been set to batch control. The second relay may be programmed as a preclose relay or as another batching relay with its own preset amount.

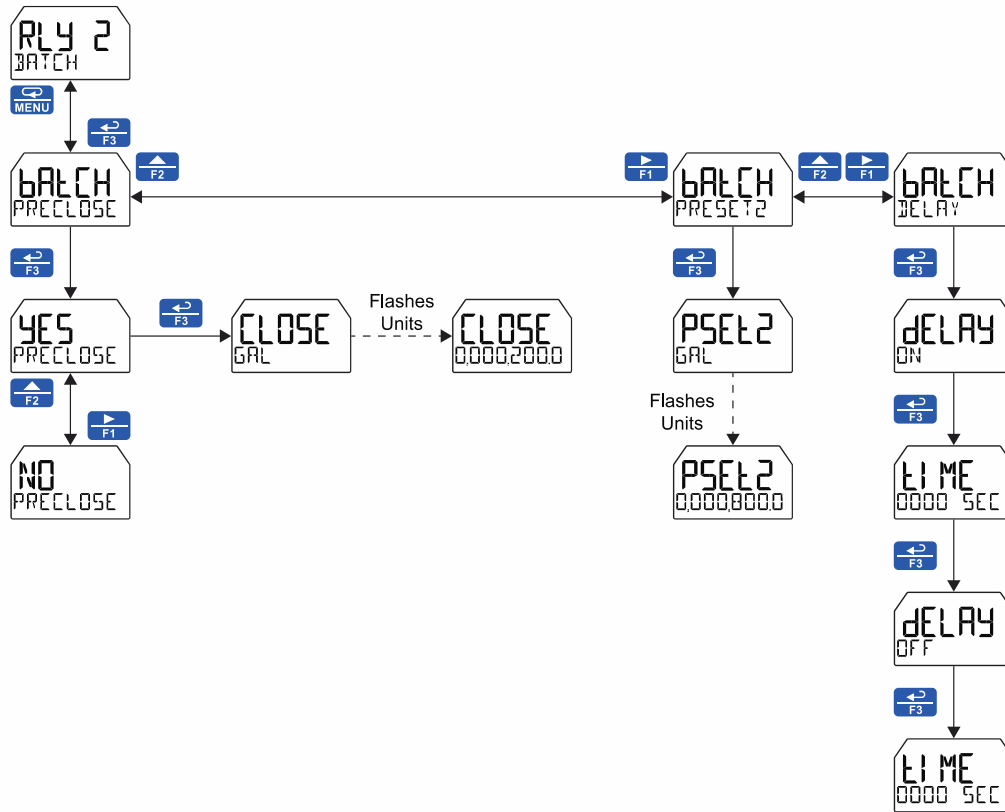

### Stopwatch (STPWATCH)

The stopwatch function may be used to manually run and control a process for a specific time interval up to 99 hrs., 59 min, and 59 seconds. The stopwatch function may be assigned to any relay. There are three settings needed to use the function effectively.

1. Assign stopwatch to either top or bottom display
2. Assign the relay to control the process (on/off)
3. Assign a function key or digital input to start/stop the stopwatch

#### Application Example

To maintain consistency of a product, it is necessary to take and test samples at different times throughout the day. The stopwatch function is used to open and close a solenoid valve to know the exact amount of time needed to complete the desired sample. Once this is determined, the timer function can be used to automatically take a sample (batch) based on the time determined using the stopwatch function.

**Setup:** Assign the following to *Stopwatch Function*

- Bottom display  
(see pages 37 & 39 for details how to change the display)
- Relay 1  
(see pages 40 & 46 how to change Open Collector and Solid-State Relay functionality)
- F3: Start/Stop  
(see pages 65 & 66 for details on how to change the function keys)

#### Procedure

- Press F3 to start the stopwatch; relay 1 turns on and the process starts running.
- Press F3 to stop the stopwatch; relay 1 turns off and the process stops.
- The bottom display indicates the time it took to complete the sample.

### Runtime & Cycle Count (INFO)

The relay information menu shows runtime and cycle count for each relay. These values may be cleared at any time by selecting the *Clear* option (CLEAR?).

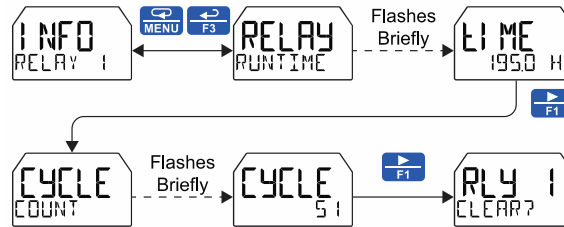

### Isolated 4-20 mA Output (4-20 mA)

The 4-20 mA menu is used to scale the isolated 4-20 mA output based on display values. This menu is not present on models without a 4-20 mA output option.

The 4-20 mA analog output (if equipped) can be scaled to provide a 4-20 mA signal for the rate or total display range or to simply retransmit the 4-20 mA input. The output may be disabled (DISABLE) and will only output the minimum signal.

Overrange and underrange values determine what mA signal the meter will output if the mA input is underrange (<3.5 mA) or overrange (>20.5 mA). This value may be set to 1 mA, 3.5 mA, 3.8 mA, 20.5 mA, 20.8 mA, 23 mA, or disabled.

No equipment is needed to scale the analog output; simply program two display values and corresponding mA output signals.

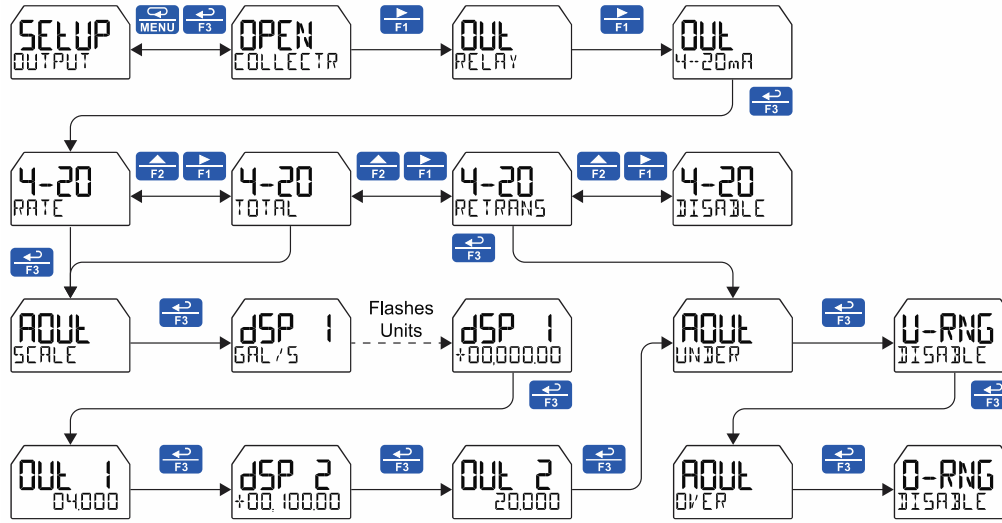

### Rate or Total (RATE or TOTAL)

To scale the analog output, enter display value 1 and a corresponding analog output value for this display, then enter display value 2 and a corresponding analog output value for this display value. This will provide a linearly scaled analog output.

### Retransmit (RETRANS)

This option will retransmit the 4-20 mA analog input without the need to scale the output.

### Output Manual Control (CONTROL)

The Control menu is used to control the open collector outputs, 4-20 mA analog output, and the relays manually, ignoring the input. Each open collector, relay, and analog output can be programmed independently for manual control. Selecting automatic control sets all relays and analog output for automatic operation.

After selecting manual control for a specific output, you can set the output value. To change the output value, return to the Control menu, select the output to control, select manual control, and enter a new value.

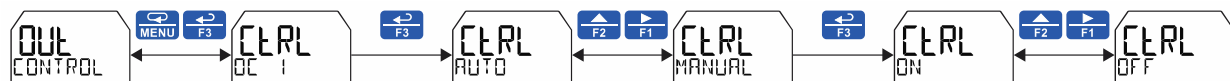

## Advanced Features Menu (ADVANCE)

To simplify the setup process, functions not needed for most applications are located in the *Advanced Features* menu. The options under advanced features include *advanced rate*, *total*, and *grand total setup*, *cutoff*, *filter*, *password*, *function key programming*, and *system settings*.

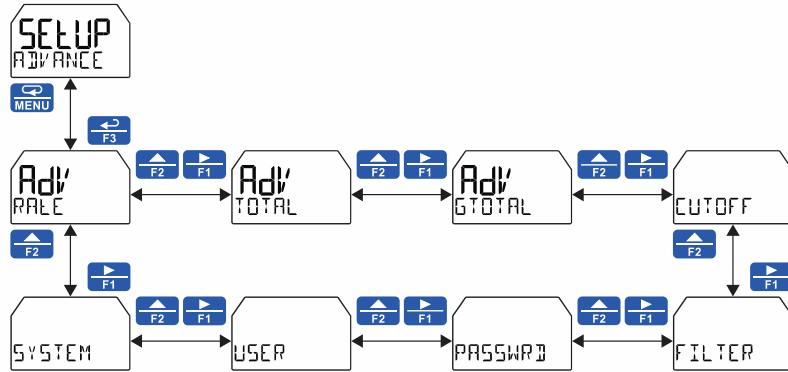

## Advanced Rate Setup (ADV RATE)

The *Advanced Rate* menu contains options to apply input signal conditioning functions to the input and scale/calibrate the input signal.

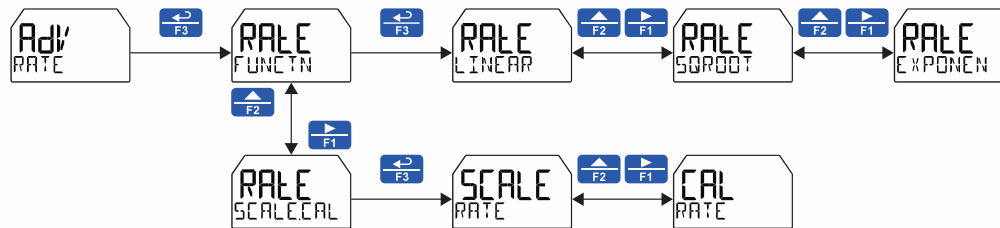

### Input Signal Conditioning Functions (FUNCTION)

The *Function* menu is used to select the input signal conditioner applied to the input: linear, square root, programmable exponent, or round horizontal tank volume calculation. Multi-point linearization is part of the linear function selection.

Meters are set up at the factory for linear function with 2-point linearization. The linear function provides a display that is linear with respect to the input signal.

#### Using MeterView XL

MeterView XL makes programming the input signal conditioning functions quick and easy. Go to the input/scale menu and select the desired function from the drop down menu in the “scale input” section.

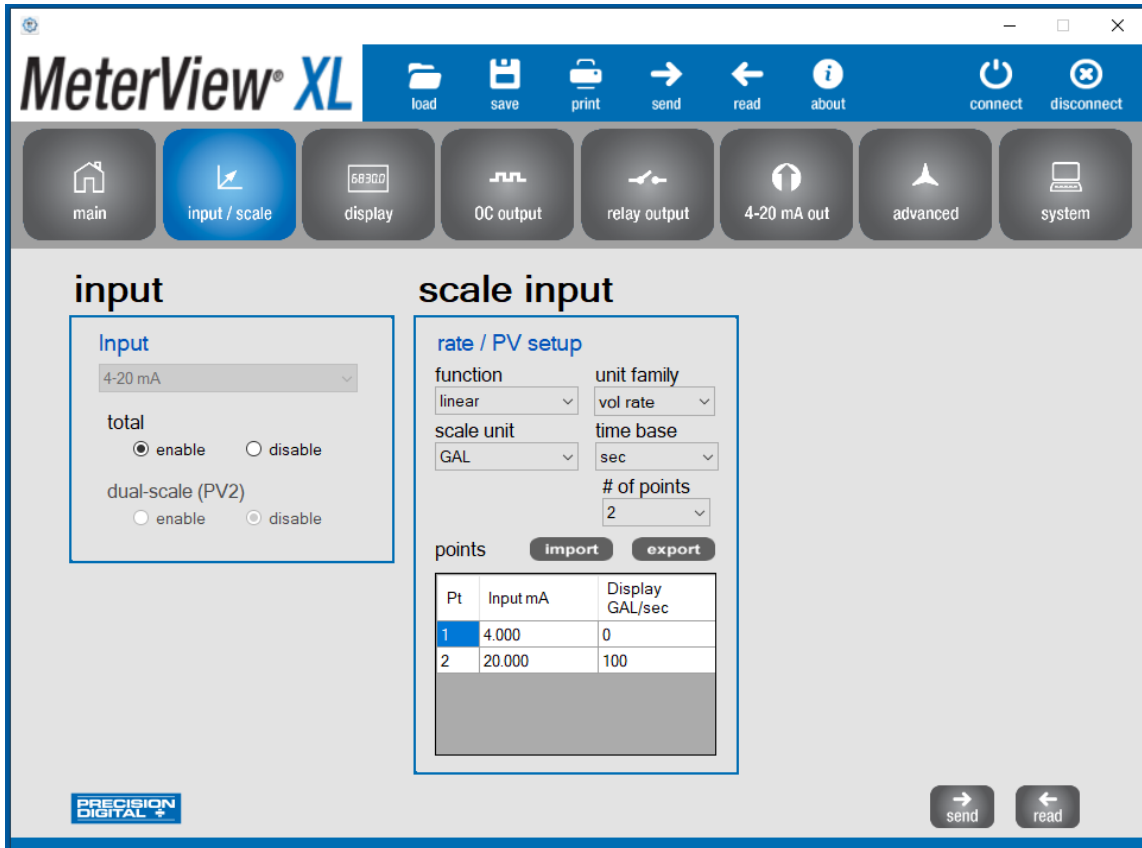

### Square Root Linearization (SORROOT)

The square root function can be used to linearize the signal from a differential pressure transmitter and display flow rate in engineering units.

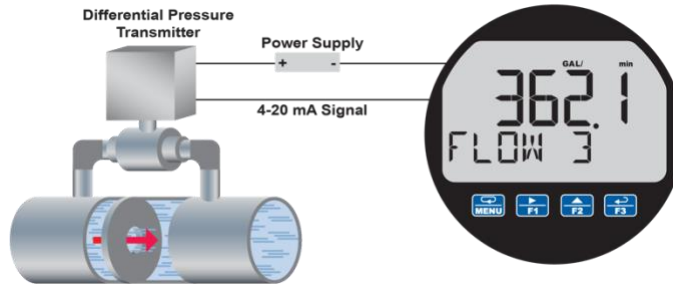

PD6928 Displaying Flow Rate by Applying the Square Root Function to the Output of a DP Transmitter.

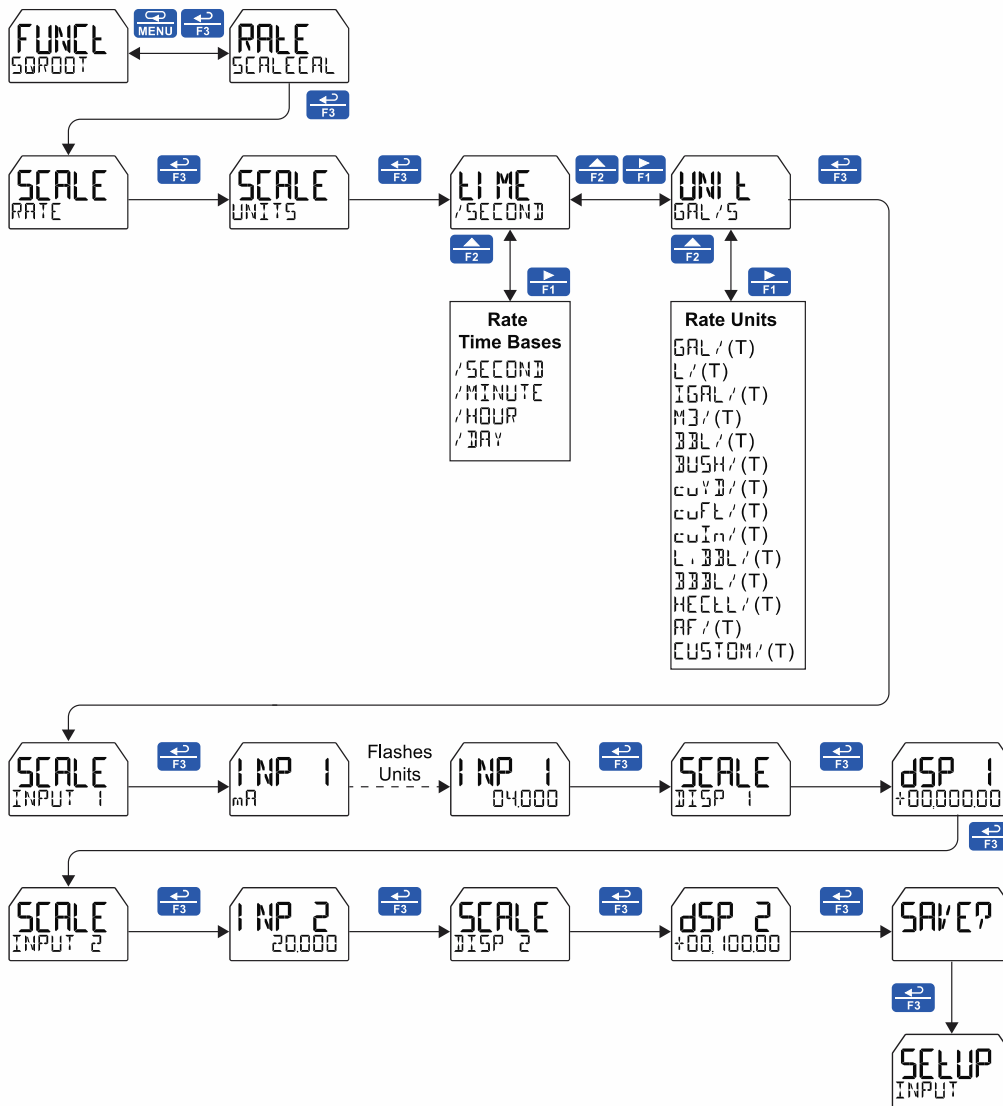



**Programmable Exponent Linearization (EXPONEN)**

The programmable exponent can be used to linearize the signal from level transmitters in open-channel flow applications using weirs and flumes.

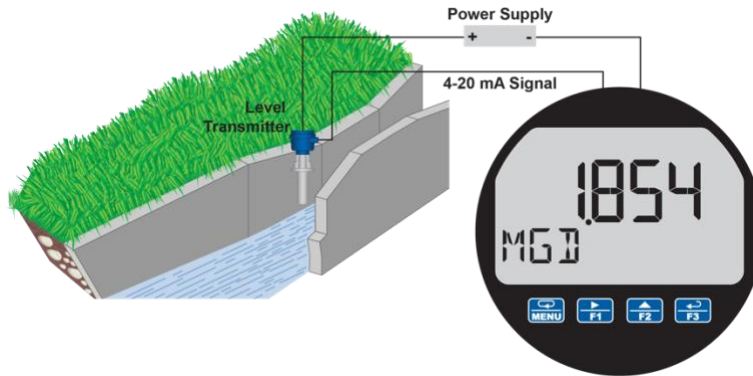

The PD6928, in combination with an ultrasonic level transmitter, makes for an economical way to measure and display open channel flow rate and total in most weirs and flumes. A guide such as the ISCO Open Channel Flow Measurement Handbook can provide the user with all the information needed: the exponent used in the flow equation for the desired flow units and the flow rate for any given head height. For example, to display the open channel flow rate from a 3" Parshall flume, the ISCO handbook advises the exponent is 1.547 and at the maximum head height of 3.0 feet, the flow rate is 3.508 MGD.

**3" Parshall Flume Discharge Table**

Formula: CFS = 0.9920 H<sup>1.547</sup>  
 GPM = 445.2 H<sup>1.547</sup>  
 MGD = 0.6411 H<sup>1.547</sup>

Where: H = Head in feet

Table 12-3			
Head (Feet)	CFS	GPM	MGD
3.00	5.428	2436	3.508

*ISCO Open Channel Flow Measurement Handbook, 3<sup>rd</sup> edition*

With this information the PD6928 should be programmed in the following fashion. This setup assumes the level transmitter is programmed to output 20 mA at the maximum head height of 3.00 feet; but any mA value at a head height with a known flow rate may be used.

Function	Desired	Programming
Open Channel Flow	3" Parshall flume	Set Programmable Exponent to 1.547
Flow Rate	Millions of Gallons per Day (MGD)	Set 4 mA = 0 20 mA = 3.508
Total	Millions of Gallons	Set Totalizer Conversion Factor = 1 (password protect "total" to avoid accidental reset)
Non-Resettable Grand Total	Program meter so grand total can never be reset	Set non-resettable grand total password
Display	Display Flow Rate	Set upper display for flow rate display and lower display units/tag for MGD.

The Programmable Exponent function is programmed in the following manner:

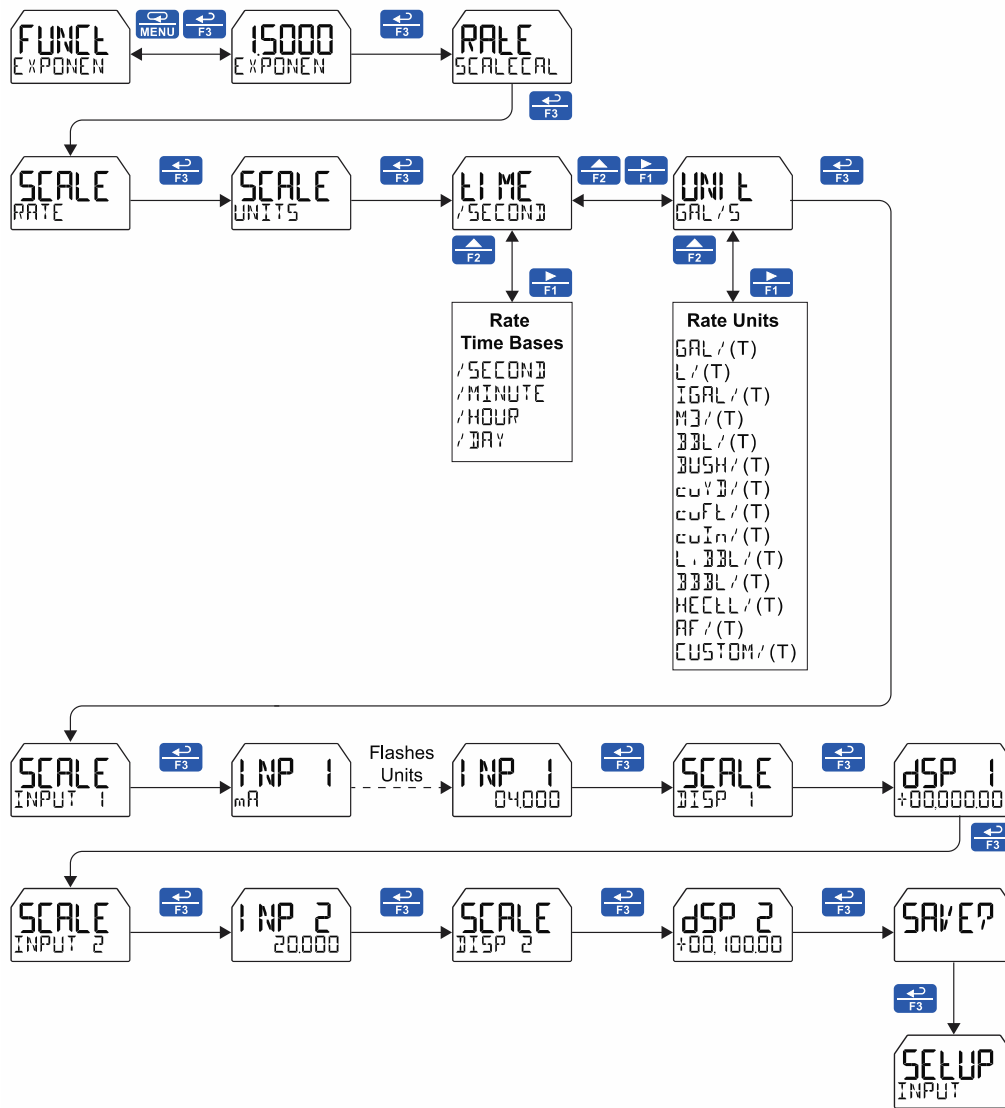

### Multi-Point Linearization (LINEAR)

Up to 32 linearization points can be selected for rate under the LINEAR function. Multi-point linearization can be used to linearize the input for non-linear signals to convert level to flow using weirs and flumes with complex equations. These points are established via direct entry (SCALE) or with a live calibration signal source (CAL).

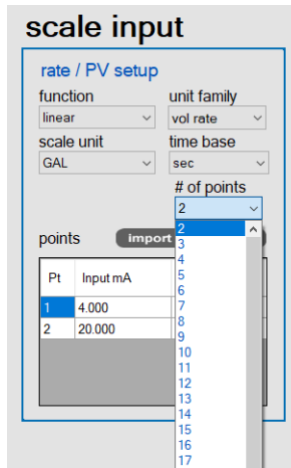

MeterView XL showing the linear points setup feature. Up to 32 points can be selected.

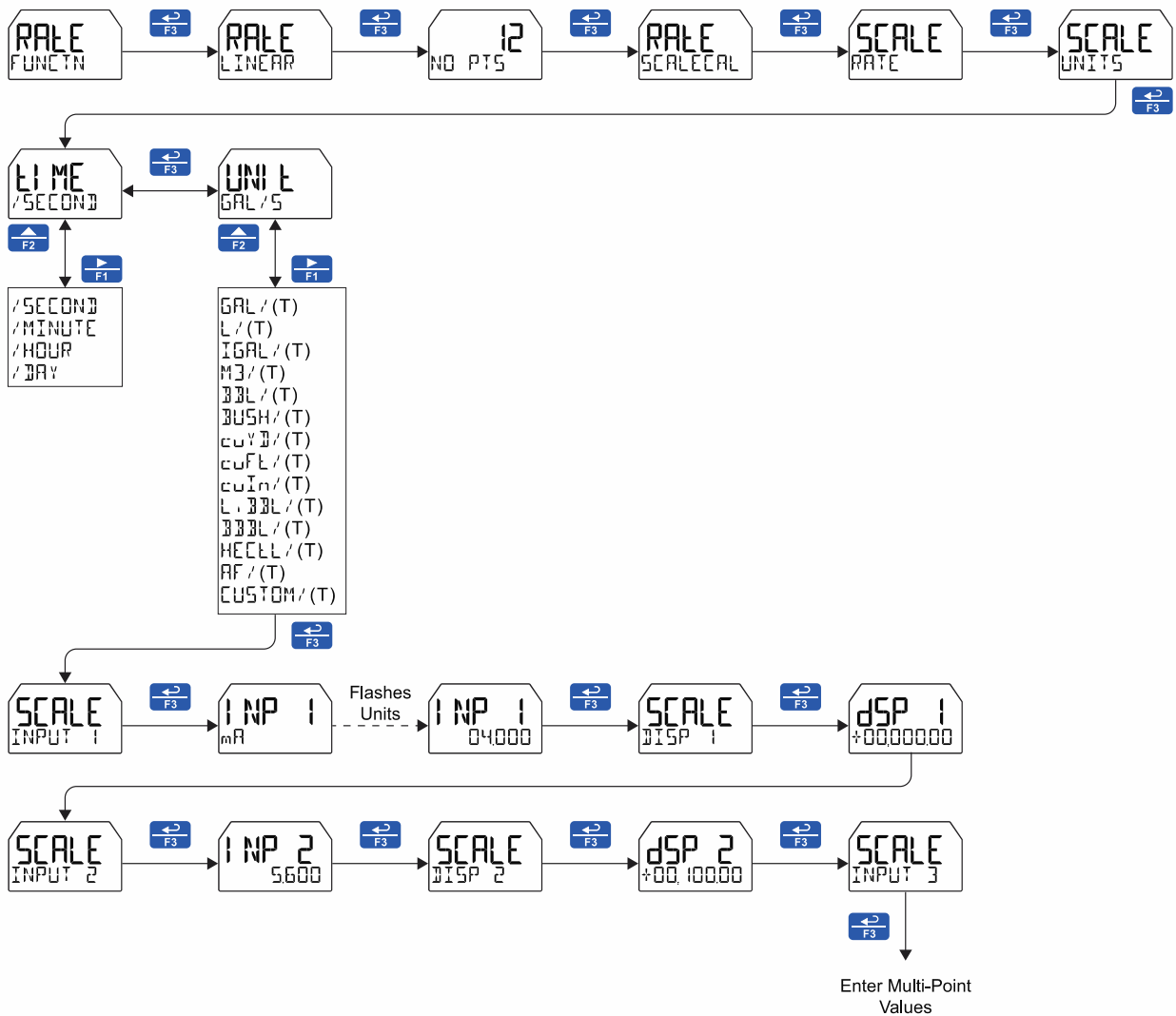

### Advanced Scaling and Calibration (SCALECAL)

This menu offers options to scale or calibrate the meter.

#### Scaling the Input (SCALE)

The scale menu in the *Advanced* menu is the same as the scale menu in the *Input* menu. See *Scaling the 4-20 mA Input (INPUT)* on page 35 for details about scaling the meter.

#### Calibrating the Input (CAL)

To scale the meter without a signal source, refer to *Scaling the 4-20 mA Input (INPUT)* on page 35.

The meter can be calibrated to display the process in engineering units by applying the appropriate input signal and following the calibration procedure. The **CAL** menu can be used either with a calibrated current source or with a live signal coming from a 4-20 mA transmitter connected to the process being measured.

During calibration, the mA input value will be displayed as **INP 1** and **INP 2**. Adjust the input source until the desired mA value is shown.

The use of a calibrated signal source is required.

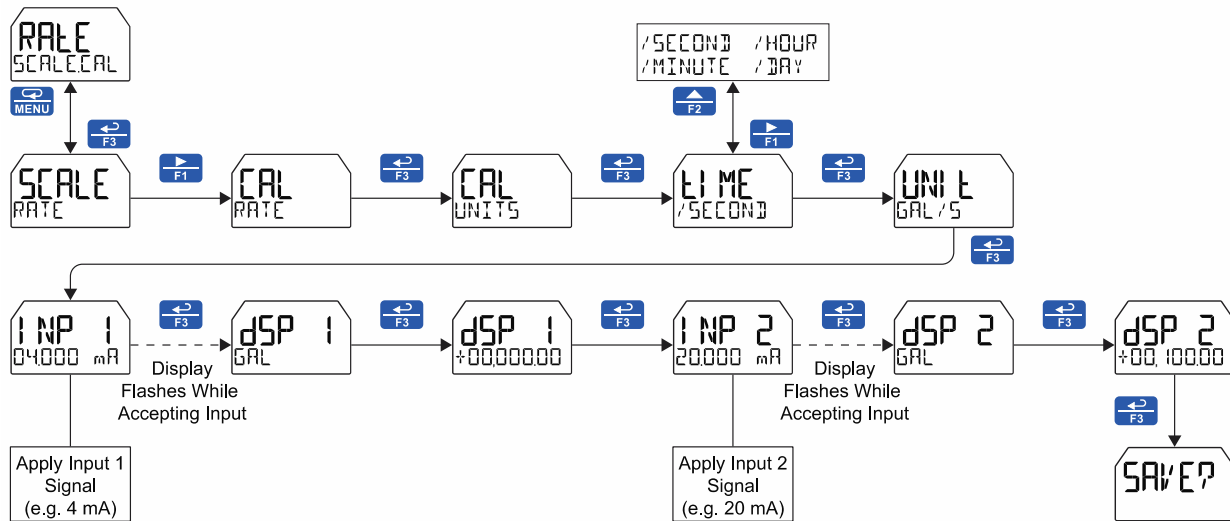

Follow these steps to calibrate the input:

1. After accessing the **SCALECAL** menu, press the **Right-Arrow** button to scroll to the *Calibration* menu (**CAL PV**) and press **Enter**.
2. Select the appropriate units for the desired process variable, then press **Enter**. For information on units, see Available Engineering Units on page 36.
3. The meter displays **INP 1**. Apply a known signal and press **Enter**. The display will flash while accepting the signal.
4. After the signal is accepted, the meter displays **DSP 1**. Enter a corresponding display value for the input signal, and press **Enter** to accept.
5. The meter displays **INP 2**. Apply a known signal and press **Enter**. The display will flash while accepting the signal.
6. After the signal is accepted, the meter displays **DSP 2**. Enter a corresponding display value for the input signal and press **Enter** to accept.
7. After completing calibration, the **SAVE ?** display will need to be acknowledged using the **Enter** key before calibration will take effect.

**Note:** The **SAVE ?** prompt is not displayed if no changes have been made to the scaling.

### Additional Engineering Units

**▲ IMPORTANT**

- If the total is disabled and the dual-scale level feature has been selected, the menus for PV1 & PV2 are enabled.
- Additional engineering units become available as shown below.

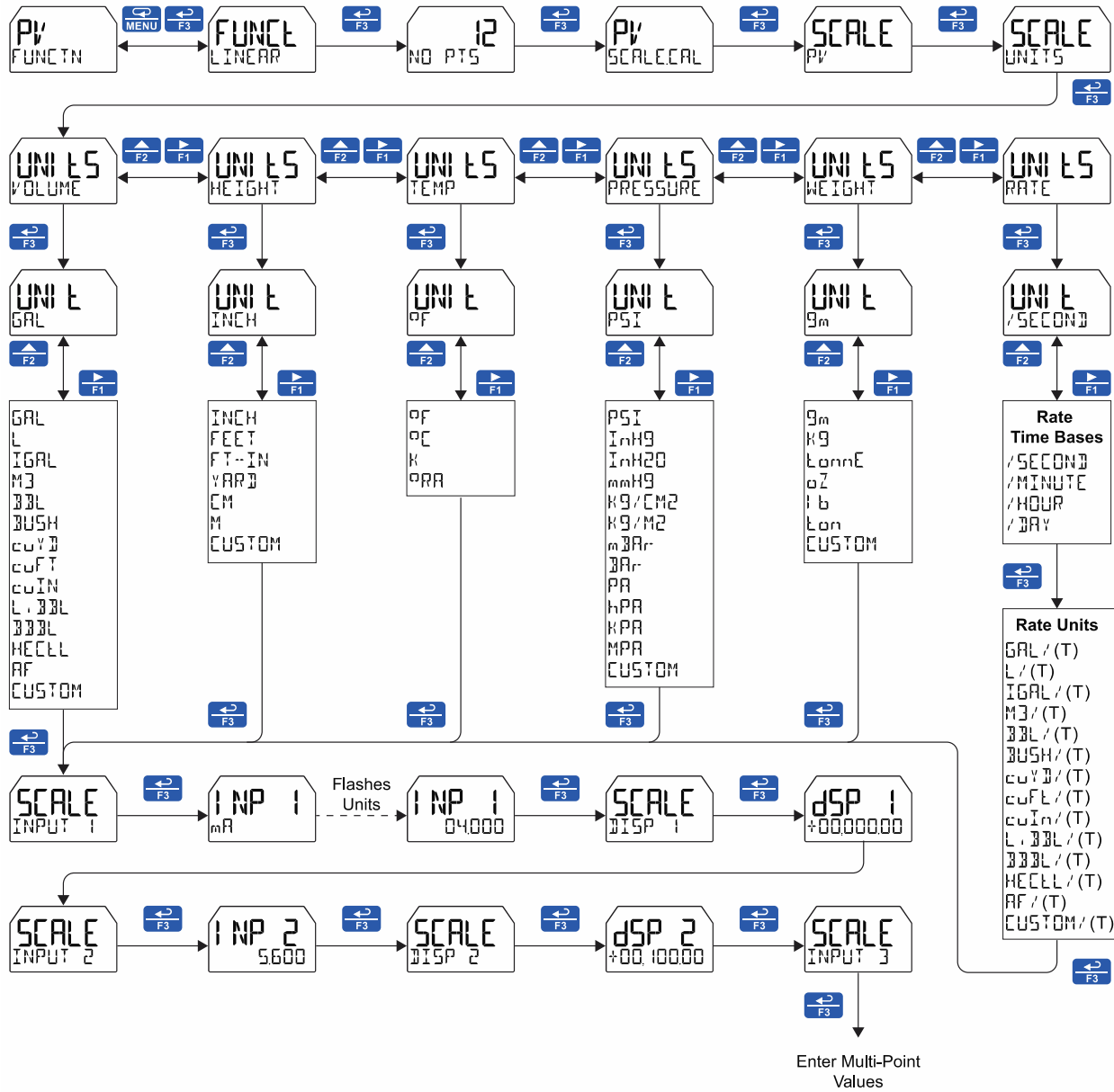

### Advanced Total and Grand Total Setup (ADV TOTAL & ADV GTOTAL)

The advanced total and grand total menu contain the count (COUNT) and reset (RESET) menus. The count menu allows the digit limit to be selected between 8-digit (bottom display only) and 13-digit (uses top and bottom display to display full number) and the initial value at which the total or grand total should start counting.

When using a 13-digit total or grand total, press the function key assigned to display (default: F1) to view the full amount once the value has exceeded 100,000,000 (decimal places are automatically truncated). If a 13-digit total or grand total is displayed on the bottom display and the value has exceeded eight digits, the truncated value will flash to indicate that it is not the complete value. To display 13-digit grand total, assigned the top and bottom display to grand total.

The reset menu is used to enable or disable the reset of the total and grand total.

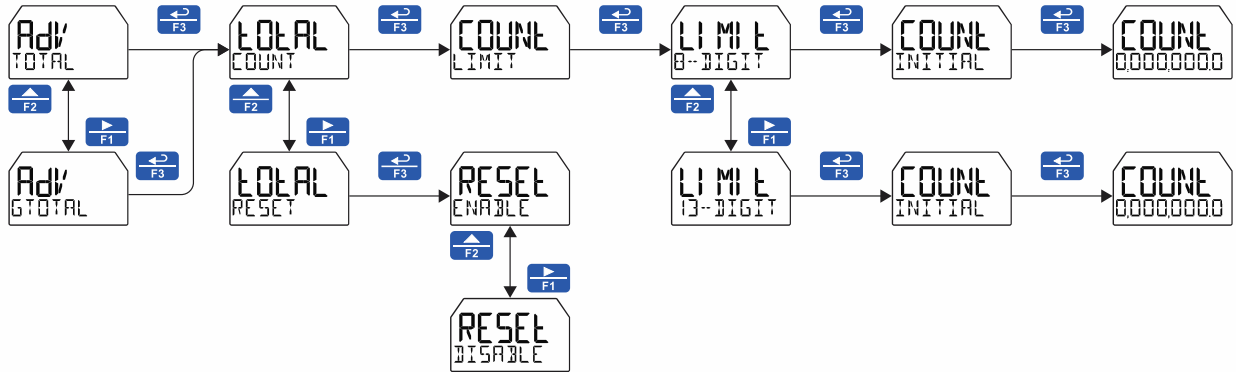

### Non-Resettable Grand Total

The grand total reset may be permanently disabled by selecting YES at the PERMLDC menu after disabling grand total reset.



**CAUTION**

- Use caution when selecting the PERMLDC feature as once the grand total reset has been permanently locked, it cannot be unlocked.

### **Low-Flow Cutoff (CUTOFF)**

The low-flow cutoff feature allows the meter to be programmed so that the often-unsteady output from a differential pressure transmitter at low flow rates always displays zero on the meter. The cutoff value may be programmed from 0.1 to 99999. The meter will display zero below the cutoff value. The cutoff can be disabled to display negative values.

### **Noise Filter (FILTER)**

The noise filter is available for unusually noisy signals that cause an unstable process variable display. The noise filter averages the input signal over a certain period of time. The filter level determines the length of time over which the signal is averaged. The filter level can be set between 1 and 16 seconds or turned off. The higher the filter level, the longer the averaging time and so the longer it takes the display to settle to its final value. Setting the filter level to off disables the filter function.

### **Noise Filter Bypass (BYPASS)**

The noise filter bypass changes the behavior of the meter so that small variations in the signal are filtered out but large abrupt changes in the input signal are displayed immediately. The bypass value determines the minimum amount of signal change to be displayed immediately. All signal changes smaller than the bypass value are filtered or averaged by the meter. The noise filter bypass may be set between 0.1 and 99.9% of full scale.

### Enabling Password Protection (PASSWRD)

The *Password* menu is used for programming security to prevent unauthorized changes to the programmed parameter settings or undesired resetting of the total or grand total. There are three separate passwords available that can be set independently of each other: *Main*, *Total*, and *Grand Total*. The *Main*, *Total*, and *Grand Total* passwords prevent access to the meter *Programming Mode*. *Total* and *Grand Total* passwords prevent resetting of the total and grand total, respectively.

To set a password, enter the *Password* menu and program a five-digit password. When a password has been enabled, the lock icon  will display in the upper-left side of the display. For instructions on how to program numeric values see *Setting Numeric Values* on page 34.

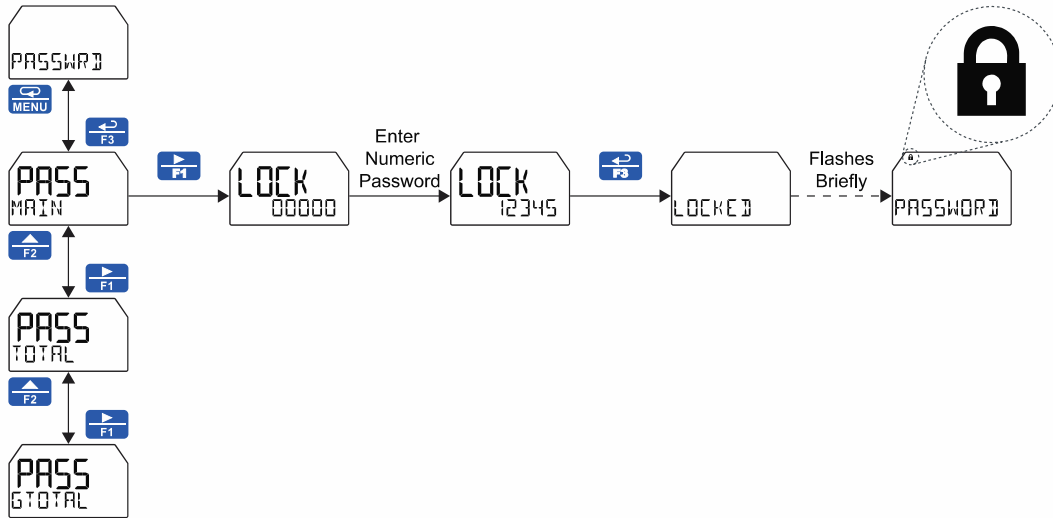

### Making Changes to a Password Protected Meter

If the *Main* password is enabled, the meter will display the message `LOCKED` when the *Menu* button is pressed. If the *Total* or *Grand Total* passwords are enabled, the meter will display the message `LOCKED` when trying to reset or change the total or grand total. Press the *Enter* button while the message is being displayed and enter the correct password to gain access to the menu. After exiting *Programming Mode*, the meter returns to its password protected condition.

### Disabling Password Protection

To disable the *Main*, *Total*, or *Grand Total* passwords, access the *Password* menu and clear the desired password either by pressing and holding the *Right Arrow* button until all digits reset to zero or manually changing all of the digits to zero. When the *Enter* button is pressed, the meter will display `UNLOCKED` and will no longer require a password to access *Programming Mode*, or a password to reset or change the total or grand total, depending on which password was cleared.

**Note:** If the meter is password protected and the password has been forgotten, the password may be overridden using the master password: **50865**



### Programmable Function Keys User Menu (USER)

The User menu allows the user to assign the CapTouch buttons function keys F1, F2, and F3, and the digital input (located on the input signal connector) to access some of the menus or to activate certain functions immediately (e.g. reset max & min, hold relay states, etc.). This allows the meter to be greatly customized for use in specialized applications.

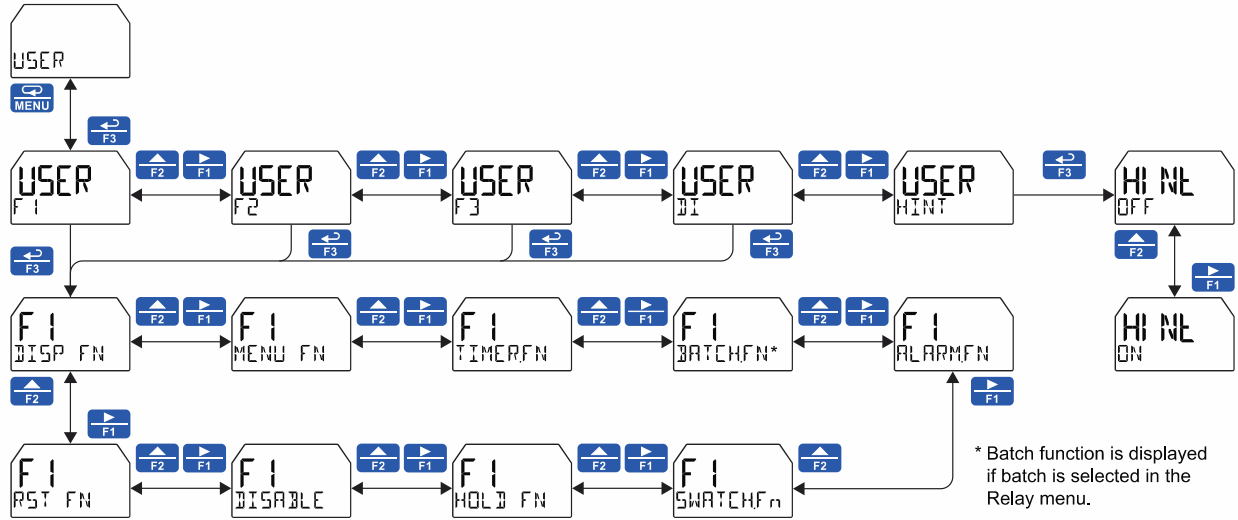

### Function Keys & Digital Input Available Settings

Refer to the following table for descriptions of each available function key or digital input setting.

Display	Description
DISP FN	Set the function key or digital input to display a value
DISPLAY	Cycle max, min, rate, total, and grand total
DISP RATE	Display the rate
DISP TOTAL	Display the total
DISP GT	Display the grand total
PCTRATE	Display the rate's percentage of max (20 mA)
DISP UNITS	Display rate, total, and grand total units
DISP TAG	Display the tags
DISP MIN	Display the minimum rate value
DISP MAX	Display the maximum rate value
MIN MAX	Display the minimum and maximum rate value
DISP mA IN	Display the current mA input value
DISP mA OUT	Display the current mA output value
MENU FN	Set the function key or digital input to access a menu
RLY INFO	Go to relay information menu (INFO)
MANCTRL	Go to output control menu (CONTROL)
TMR OC 1	Open collector 1 timer
TMR OC 2	Open collector 2 timer
TIMER R 1	Relay 1 timer
TIMER R 2	Relay 2 timer
TIMERFN	Set the function key or digital input to start or stop a timer
STARTALL	Start all timers
STOPALL	Stop all timers
SSTPALL	Start or stop all timers
OC 1	Start/stop open collector 1 timer
OC 2	Start/stop open collector 2 timer
RLY 1	Start/stop relay 1 timer
RLY 2	Start/stop relay 2 timer
START	Start the selected timer output
STOP	Stop the selected timer output
STR--STP	Start or stop the selected timer output
BATCHFN	Set the function key or digital input to batch control
START	Start a batch
STOP	Stop a batch
STR--STP	Start or stop a batch
PRESET	Preset batch amount

Display	Description
ALARMFN	Set the function key or digital input to acknowledge an alarm
ACK	Acknowledge all active alarms
SETPPOINT	Set all output set point
SETPTOC 1	Set open collector 1 set point
SETPTOC 2	Set open collector 2 set point
SETPTR 1	Set relay 1 set point
SETPTR 2	Set relay 2 set point
SWATCHFN	Set the function key or digital input to activate stopwatch
START	Start the stopwatch
STOP	Pause/Stop the stopwatch
STR--STP	Start or stop the stopwatch
HOLD FN	Set the function key or digital input to hold an output
HOLD OUT	Hold all outputs
HL UNHLD	Hold or un-hold all outputs
OC 1+2	Hold/un-hold open collector outputs
RLY 1+2	Hold/un-hold relay outputs
mAOUT	Hold/un-hold 4-20 mA output
HOLD	Hold selected output
HL UNHLD	Hold or un-hold selected output
DISABLE	Disable the function key or digital input
RST FN	Set the function key or digital input to reset a value
RESET	Reset min, max, or max/min PV value
R MINMAX	Reset max and min PV value

### Enabling the Function Key Hint Feature (HINT)

Enabling the function key hint feature will cause a hint message to be displayed when pressing the F1, F2, or F3 function keys. This text gives a brief description of what the button is programmed to do. Pressing that function key a second time will execute that action.

The hint feature does not affect the digital input (DI) which is intended for immediate execution.

### Changing System Settings (SYSTEM)

The System menu contains the following menus: *Analog Output Calibration, Restore Factory Defaults, Totalizer, Backlight, CapTouch Buttons Operation Mode, Information, and Internal Calibration.*

**Note:** The Analog Output Calibration menu is available only if the option is installed.

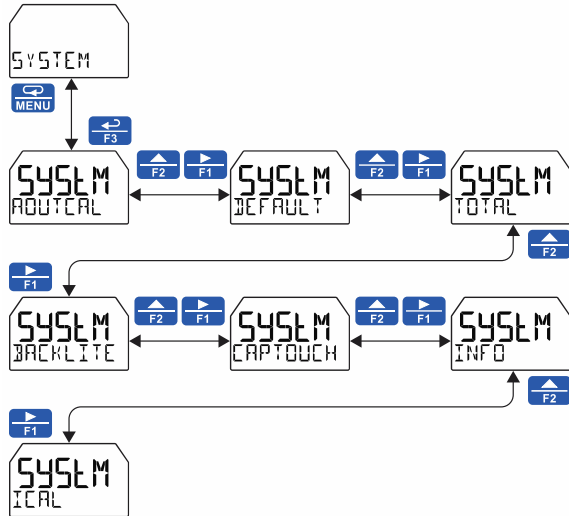

### Analog Output Calibration (ADOUTCAL)

To perform the analog output calibration, it is recommended to use a milliamp meter with a resolution of at least 0.1  $\mu$ A to measure the output current. The values saved internally during this procedure are used for scaling the 4-20 mA output in the *Setup* menu.

#### 4-20 mA Output Calibration Procedure

1. Go to the *Advanced Features* menu and navigate to the **SYSTEM** menu and press Enter. Navigate to **ADOUTCAL** and press Enter.
2. The display will show 4 mA. The ProtEX+ mA output should now be close to 4 mA. Enter the actual value read by the digital mA meter on the bottom display and press Enter.
3. The display will show 20 mA. The ProtEX+ mA output should now be close to 20 mA. Enter the actual value read by the digital mA meter on the bottom display and press Enter.
4. The ProtEX+ will now calculate the calibration factors and store them.
5. Press Menu to exit.

### Disabling the Totalizer (TOTAL)

The totalizer can be disabled using the **SYSTEM - TOTAL** menu. With the totalizer disabled, the meter will behave as a PD6908 process meter. Refer to the LIM6908 instruction manual for instructions about programming the process meter.

### Enabling or Disabling the Backlight (BACKLITE)

The backlight may be enabled or disabled using the System - Backlight menu. The backlight is enabled by default, but the input must be wired appropriately for the backlight to function. See *Wiring Diagrams* on page 24.

### CapTouch Buttons Operation Mode (CAPTOUCH)

CapTouch buttons have two modes of operation: Normal and Delayed. Delayed mode prevents accidental trigger of the buttons. In the Delayed mode, the buttons enter into a low sensitivity state (sleep) and they ignore quick button presses after 20 seconds of inactivity. To wake up the buttons, press and hold any button for more than 2 seconds, the buttons respond normally.

### Viewing System Information (INFO)

System information, such as software (firmware) number and version, model number, and system tag, may be viewed in the INFO menu. Press the *Right Arrow* button to cycle through all available meter information. Press *Menu* to go back to the previous menu.

### Calibrating the Internal mA Reference (ICAL)

The meter is factory calibrated prior to shipment to display 0.00 to 100.00, which corresponds to the 4-20 mA input. The calibration equipment is traceable to NIST standards.

The use of calibrated signal sources is necessary to calibrate the internal source of the meter. The meter's internal source is what allows the user to scale the meter without applying a signal.

Check calibration of the meter at least every 12 months.

**Note:** Allow the meter to warm up for at least 15 minutes before performing the internal source calibration procedure.

The *Internal Calibration* menu is part of the *Advanced* menu. Internal Calibration is performed as follows:

1. Press the **Menu** button to enter *Programming Mode*.
2. Press the **Up-Arrow** button **twice** and press **Enter** to access the **Advanced** menu.
3. Press the **Up-Arrow** button and press **Enter** to access the **System** menu.
4. Press the **Up-Arrow** button and press **Enter** to access the **ICAL** menu.
5. The meter displays *low* input current message (4000 mA). Apply a 4 mA signal and press **Enter**. The display flashes for a moment while the meter is accepting the low input signal.
6. After the display stops flashing, the display moves to the *high* input calibration (20000 mA). Apply the high input signal and press **Enter**. The display will flash again while the meter is accepting the high input signal.

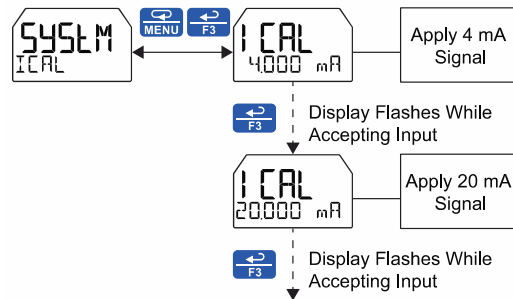

## Meter Operation

The meter is equipped with four CapTouch through-glass buttons. These buttons allow meter operation without removing the cover and exposing the electronics in a hazardous area.

Three CapTouch buttons labeled F1, F2, and F3 can be programmed as function keys to perform a variety of meter functions simply by pressing on the glass over the button. These include resetting the total, resetting the meter's relays or open collectors, starting and stopping timers, displaying max/min values and starting/stopping batches. See *Function Keys & Digital Input Available Settings* on page 66 for a complete list of settings available.

A digital input is available on the meter, and it may function in a similar fashion as the function keys to allow remote operation of a single task.





The max & min readings (peak & valley) reached by the process can be displayed either continuously by assigning it to a display line in the *Display* menu, or momentarily by pressing the F1 key (default) or assign it to any of the other function keys or the digital input.

Pressing the F1 key cycles through various display values (e.g. Grand total, max, min); press the Enter key to lock the display in the current process value and press the Enter key again to unlock the display.

The relay information menu shows runtime and cycle count for each relay.

Change the display units within the selected unit class at any time without the need to re-scale the meter. Select the desired units via the **UNITS** menu in the **DISPLAY** menu, and the meter automatically converts the display values to the new unit of measure.

## CapTouch Buttons Operation



Button	Description (Default Settings)
	Press to enter or exit <i>Programming Mode</i> , view settings, or exit max/min readings.
	Press to display grand total. Continue pressing to cycle through max, min, rate, and total displays.
	Press to access the Reset menu. Press F1 to scroll through the options. Press F3 to reset the currently displayed parameter.
	Press to acknowledge all manually resettable relays or open collectors. Press to lock/unlock the display value after pressing the F1 key.

## CapTouch Buttons

The PD6928 is equipped with four capacitive sensors that operate as through-glass buttons so that it can be programmed and operated without removing the cover (and exposing the electronics) in a hazardous area.



These buttons can be turned off for security by selecting the *Off* setting on the switch located on the side of the display module, close to the Menu button.

To actuate a button, press one finger to the window directly over the marked button area. When the cover is removed, the CapTouch buttons can be used after the meter completes a self-calibrating routine (hand symbol  flashes). The sensors are disabled when more than one button is pressed, and they will automatically re-enable after a few seconds (hand symbol  off).

## CapTouch Button Tips & Troubleshooting

The CapTouch buttons are designed to work under any lighting condition and to protect against false triggering. If the CapTouch buttons are not needed during operation, they can be turned off (slide switch to *Off*).

- To remove cover with power applied (safe area only) or to clean the window, place your hand over the buttons; this will temporarily disable the CapTouch buttons to prevent inadvertent use.
- Keep the window clean.
- Tighten the cover securely.
- Use a password to prevent tampering.

### IMPORTANT

- CapTouch buttons will not work if two or more buttons are detected as being pressed simultaneously. Be careful to avoid triggering multiple buttons or reaching across one button location to press another.

## Function Keys Operation

During operation, the programmable function keys operate according to the way they have been programmed in the *Advanced Features – User* menu. The table under *CapTouch Buttons Operation* on page 69 shows the factory default settings for F1, F2, and F3.

A hint message may be enabled to provide a description of what each function key does prior to executing their assigned function. See *Enabling the Function Key Hint Feature (HINT)* on page 66.

## Digital Input Operation

A digital input is standard on the meter. This digital input is programmed identically to function keys F1, F2, and F3. The input is triggered with a contact closure between DI+ and DI-, or with an active low signal. During operation, the digital input operates according to the way it has been programmed in the *Advanced Features – User* menu. Factory default setting is to reset total.

## Maximum/Minimum Readings

The max & min readings (peak & valley) reached by the process can be displayed either continuously or momentarily.

Display momentarily by pressing the F1 function key (default) or assigning to any of the other function keys or to the digital input in the *User* menu.

Display continuously by pressing the **Enter** button while the max/min is being displayed to lock the display. Press **Enter** again to unlock.

Any of the F1-F3 function keys (buttons) and the digital input can be programmed to reset the max & min readings. The meters are set at the factory to display the max reading by pressing the *Right Arrow/F1* button and to use the *Up-Arrow/F2* button to access the *Reset* menu. Press the *Right Arrow* button to cycle through the available parameters to reset.

**Top Display:** Process Value  
**Bottom Display:** Max & Min

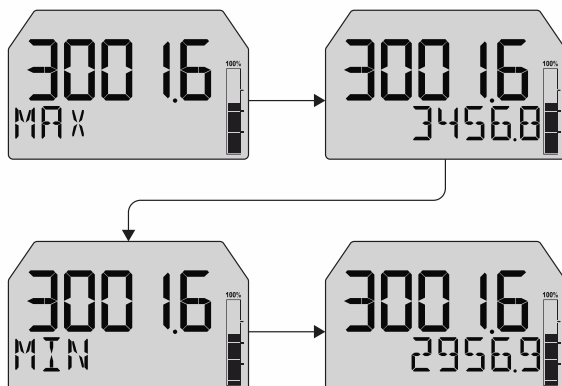

## Total Reset Capabilities

The total and grand total can be reset using a CapTouch button, an external contact closure on the digital input, or MeterView XL software. In addition, both total and grand total reset can be password protected to prevent unauthorized resets.

### Total Reset via CapTouch Button

The CapTouch function key F2 is set up to reset the total. If reset grand total is enabled, it is possible for the user to reset either the total or the grand total without removing the cover or the need for external devices.



### Total Reset via Digital Input

The PD6928's digital input can also be used to reset the total or grand total.

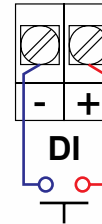

### Total Reset Password Protection

Total and grand total passwords can be set to prevent resetting the total or grand total unless a password is entered. Grand total reset can be disabled through the meter interface, and it can also be permanently disabled. See *Enabling Password Protection (PASSWORD)* on page 64.

### Non-Resettable Grand Total

The user can set up the grand total to be non-resettable by selecting **YES** at the **PERMLOC** menu; see page 62 for details. Once this is done, the grand total can never be reset.

## Runtime & Cycle Count (INFO)

The relay information menu shows runtime and cycle count for each relay. These values may be cleared at any time by selecting the *Clear* option (CLEAR?). If the cycle count or runtime values need to be changed on a frequent basis, it would be convenient to set up a CapTouch button or the digital input to simplify this process.

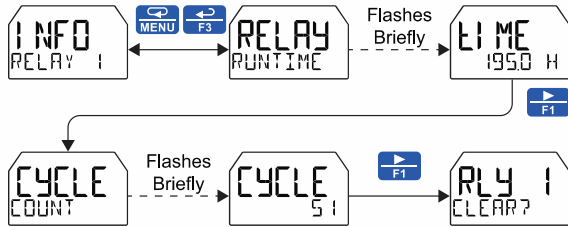

**Note:** See the menu tree under *Solid-State Relay Outputs (RELAY)* on page 46 for complete menu structure on this feature.

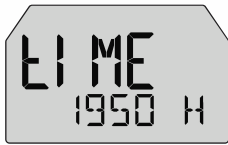

Meter displaying the amount of time a relay has been activated



Meter displaying the number of times a relay has cycled

## Changing Engineering Units

During operation of the meter, it is possible to change the display units within the selected unit class without the need to re-scale the meter. The **UNITS** menu in the **DISPLAY** menu allows the unit of measure to be changed (e.g. from gallons/second (GAL/S) to liters/second (L/S)) and the meter will automatically convert the display values to the new unit of measure. If entering a custom unit (CUSTOM), a custom conversion factor will need to be entered. See *Changing the Engineering Units (UNITS)* on page 37.

## Batch Controller Operation

Selecting batch control for relay 1 enables the batching features on the meter. The top display is changed to show the total and the bottom display is changed to display the preset batch amount. The function keys are changed so that F1 starts a batch, F2 opens the preset menu to allow the preset value to be changed, and F3 stops the currently running batch. Enabling batch control for relay 1 allows access to the batch menu under relay 2 (this menu does not appear by default). Refer to page 73 for details to setup the batch controller features.

The PD6928 has two open collector outputs that can be used for alarm indication. A 4-20 mA output option is also available for retransmitting the process variable.

## Default Batch Control Operation

The following describes the operation of the three operating keys as programmed with default settings. The digital input can be used to start and stop the batch using a momentary pushbutton. See examples for *Manual Batch Control* on page 75 and *Automatic Batch Control* on page 76.

### START Key (F1)

Press the START button to begin a new batch process. Press the START button to resume a batch that has been stopped.

### BATCH Key (F2)

Press the Batch button to access the Preset (batch amount) menu. Program the batch with the arrow keys and confirm with the Enter key.

### STOP Key (F3)

Press the STOP key once during a batch to pause. Press the STOP key while paused to stop and cancel the batch.

**⚠ WARNING**

- **Only the STOP Key is Enabled when a Batch is Running.** During a batch process, only the pause/stop functions are operational, other keys are deactivated.

## Batch Control Operation Example

The following example shows how two-stage manual batch control functions with a PD6928. This setup will establish a 55-gallon preset for the batch, with a main valve (high flow) that will close at 50 gallons, and a trickle valve (low or restricted flow) that will close at 55 gallons. Because the first batch overruns by 0.10, the batch preset will be changed to 54.90 for the next batch to compensate for overrun.

### Two-Stage Manual Batch Control Setup Using Relays 1 & 2

The following table shows the parameters as they appear within the `OUT RELAY` menu.

Parameter	Setting	Function
RELAY OUTPUT 1	RLY 1 BATCH	Press Enter to assign relay 1 batch parameters.
BATCH COUNT	UP or DOWN	Setup batch to count up or down.
BATCH MAXIMUM	1000 GAL	This setting prevents the operator from entering a preset value that exceeds a safety limit for the batch process.
BATCH MODE	MANUAL AUTO	Press Enter to select manual or automatic batch control.
BATCH PRESET	5500 GAL	Enter the batch size.
BATCH DELAY	ON & OFF	Enter the On & Off time delays for relay 1, if desired.
RELAY OUTPUT 2	RLY 2 BATCH	Press Enter to assign relay 2 batch parameters.
BATCH PRECLOSE	YES PRECLOSE  500	Set the pre-close value to 5 to close the valve being controlled by relay 2 so it closes five gallons before reaching the preset.
BATCH DELAY	ON & OFF	Enter the On & Off time delays for relay 2, if desired.
RELAY MESSAGE	MSG RELAY 1	Enter a message to be displayed while relay 1 is on, if desired.
	MSG RELAY 2	Enter a message to be displayed while relay 2 is on, if desired.

If only one-stage batch control is desired, do not assign relay 2 to batch. The following pages show illustrations of how the above settings control the batch operation. The display assignment shown is the default.



### Batch Control Relay 1

The batch total can be set to count UP or DOWN.

The batch MAXIMUM is the max preset amount that can be batched.

Batching mode can be set to either manual or automatic operation (MANUAL or AUTO). If setting batching to automatic, a delay before the next batch is started must be programmed.

The PRESET amount is the value at which the batch will stop and can be programmed up to the value assigned in the MAXIMUM menu.

An on and off delay may be set for batching relays.

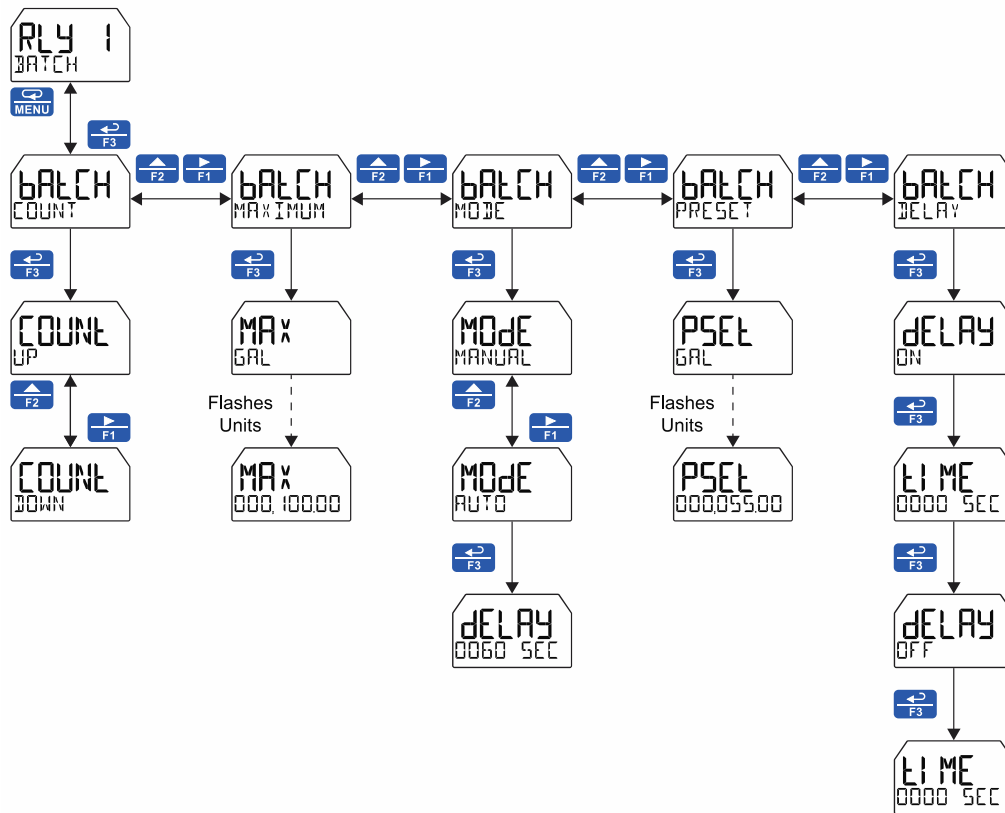

**Batch Control Relay 2**

The **BATCH** option only appears under relay 2 if relay 1 has also been set to batch control. The second relay may be programmed as a preclose relay or as another batching relay with its own preset amount.

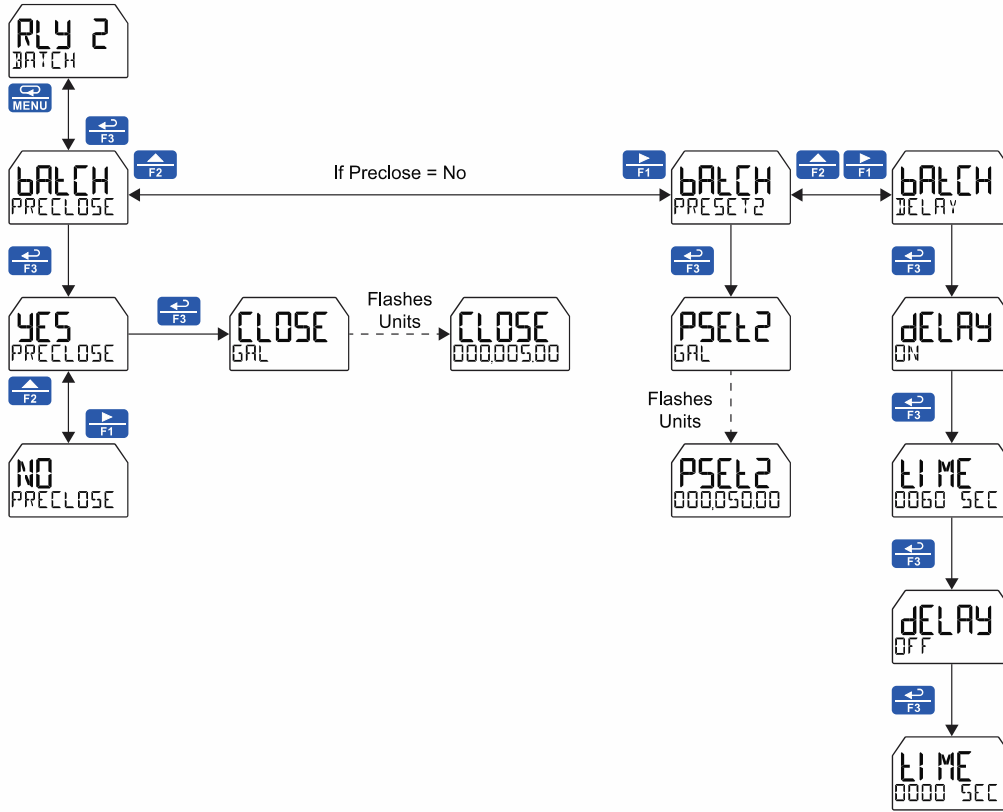

## Manual Batch Control

The manual batch control feature is used for batch processes that the operator wants to start manually. It can also be used where the batch size needs to be manually adjusted for each batch. The batch can be controlled by the button on the meter or the digital input.

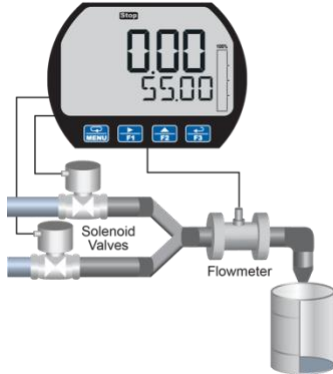

### System Setup

Both valves are closed with an empty barrel in place. The batched total is displayed in the upper display, the preset is selected for the lower display.

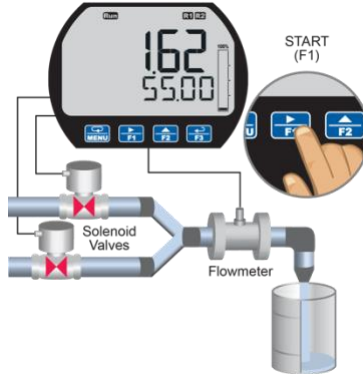

### Batch Start

The START button or (F1) is pressed. Both valves open. The barrel begins to fill.

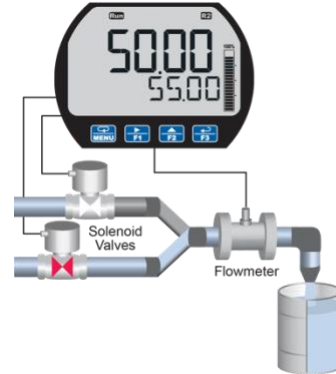

### Preclose Valve

When the batch total reaches a value of 50.00 (Preset [55.00] – Pre-close [5.00]) the full-flow valve closes. The fill rate of the tank slows as a result.

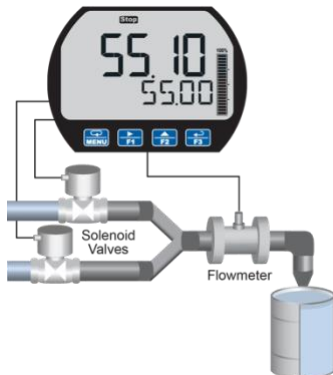

### Completed Batch

When the batch is complete, the restricted-flow valve closes. If overrun occurs, then the preset must be adjusted to compensate for the overrun. The next batch will only start after the START button or (F1) is pressed.

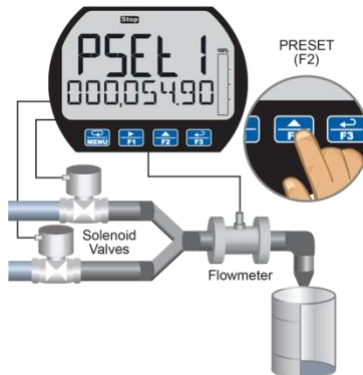

### Overrun Correction

To compensate for overrun in the previous batch, adjust the preset to 54.90, so that the next batch is accurate (55.00).

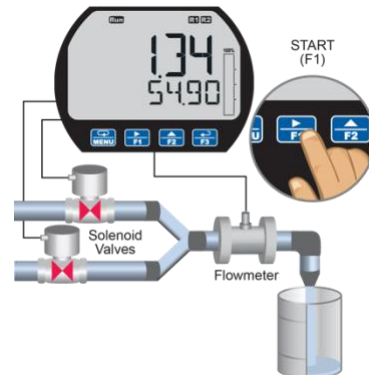

### Manual Start of Next Batch

A new, empty, barrel is put in place and the START button or (F1) is pushed to manually start the next batch.

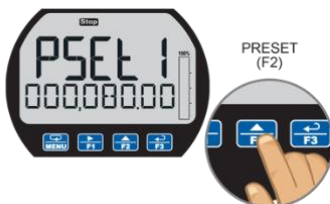

### Change Batch Size

While the process is stopped, a new preset fill amount may be selected with the Batch key (F2) for a different size barrel.



### Pause/Stop

At any time, press the STOP button or Stop key (F3) once to pause the process, or twice to cancel the batch, which stops the process.



### Resume Batch

If the batch has been paused, then press START button or (F1) to resume the batch process.

## Automatic Batch Control

The automatic batch control feature is used for batches that start automatically once the previous batch is completed. There is no opportunity for the operator to change the batch size between batches. The batch can be controlled by the button on the meter or the digital.

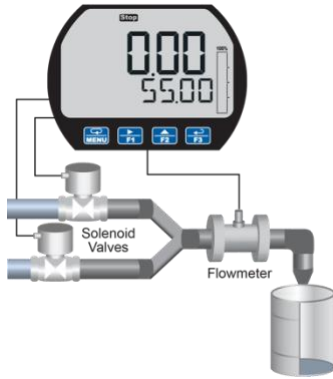

### System Setup

Both valves are closed with an empty barrel in place. The batched total is displayed in the upper display, the preset is selected for the lower display.

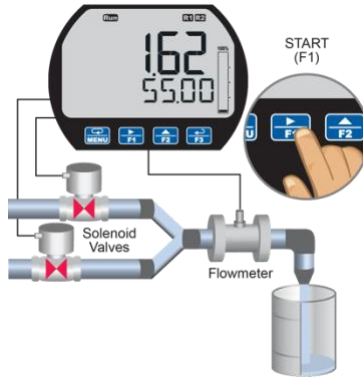

### Batch Start

The START button or (F1) is pressed. Both valves open. The barrel begins to fill.

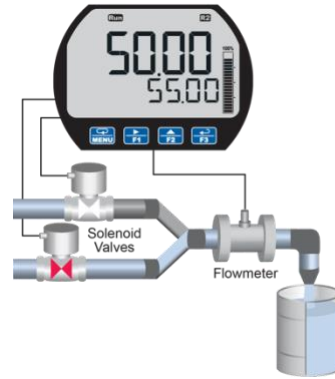

### Preclose Valve

When the batch total reaches a value of 50.00 (Preset [55.00] – Pre-close [5.00]) the full-flow valve closes. The fill rate of the tank slows as a result.

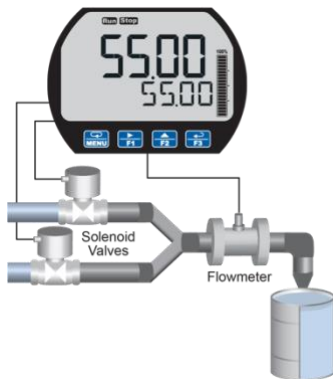

### Completed Batch

When the batch is complete, the restricted-flow valve closes. If overrun occurs, then the preset must be adjusted to compensate for the overrun.

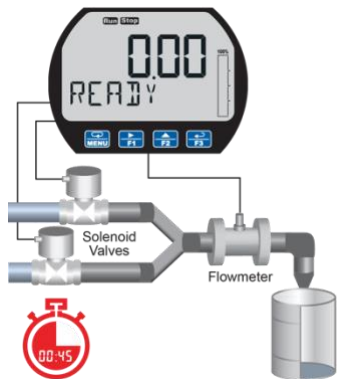

### Start Delay

After the batch is completed, the operator removes the full barrel and places an empty barrel; the new batch starts automatically after 60 seconds (Time Delay).

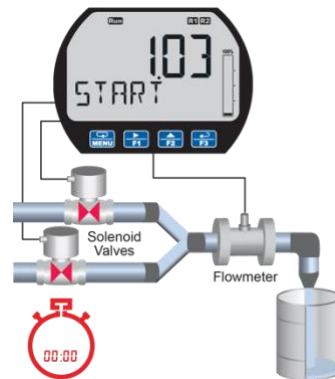

### Automatic Start of Next Batch

The new batch begins automatically after 60 seconds, both relays activate and both valves open.



### Pause

At any time, press the STOP button or Stop key (F3) once to pause the process.



### Resume Batch

If the batch has been paused, then press START button or (F1) to resume the batch process.



### Stop Process

At the end of the shift, press STOP button or Stop key (F3) twice to stop the batch process.

## Troubleshooting

This product is a highly sophisticated instrument with an extensive list of features and capabilities. If the CapTouch buttons are used to program the meter, it can be a difficult task to keep everything straight. That is why we strongly recommend the use of the free [MeterView XL](#) software for all programming activities. A cable is provided to use the MeterView XL software for programming the meter.

If you have programmed the meter with the CapTouch buttons and it is not working as intended, try re-programming the meter using the MeterView XL software.

## Reset Meter to Factory Defaults

When the parameters have been changed in a way that is difficult to determine what's happening, it might be better to start the setup process from the factory defaults. This can be accomplished using MeterView XL software or with the CapTouch buttons.

To load factory defaults:

1. Press the **Menu** button to enter *Programming Mode*.
2. Press the **Right-Arrow** button **twice** and press **Enter** to access the **Advanced** menu.
3. Press the **Up-Arrow** button and press **Enter** to access the **System** menu.
4. Press the **Right-Arrow** button and press **Enter** to access the **Default** menu.
5. Press **Enter** twice in quick succession. The meter will load default settings and restart.

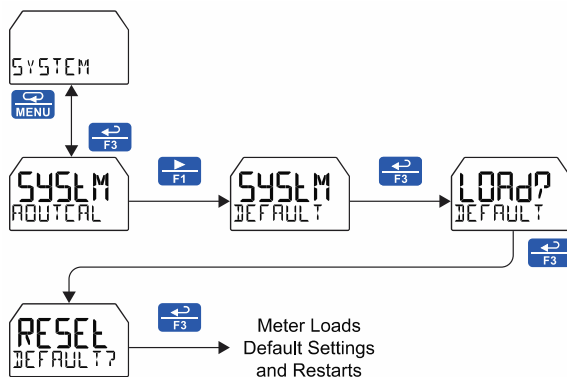

## Determining Software Version

To determine the software (firmware) version of a meter:

1. Press the **Menu** button to enter *Programming Mode*.
2. Press the **Up-Arrow** button **twice** and press **Enter** to access the **Advanced** menu.
3. Press the **Up-Arrow** button and press **Enter** to access the **System** menu.
4. Press the **Up-Arrow** button **twice** and press **Enter** to access the **Info** menu.
5. Press the **Right-Arrow** button to cycle through the meter information. When done, press the **Menu** button to return to the previous menu or press & hold **Menu** to exit to Run mode.

### Factory Default Settings

The following table shows the factory setting for most of the programmable parameters on the meter.

Parameter	Display	Default Setting
<b>Input Menu</b>		
Rate Units	UNITS	Gallons/second
Input 1	INP 1	4.000 mA
Display 1	DSP 1	0.00
Input 2	INP 2	20.000 mA
Display 2	DSP 2	100.00
<b>Output Menu</b>		
Open Collector Output 1	OUTPUT 1	Disabled
Pulse Factor	FACTOR	1.0
Test Frequency	FREQ	100
Alarm	ALARM	Rate
Alarm Action	ACTION	AUTO
Set Point	SET	20.00
Reset Point	RESET	10.00
Alarm On Delay	DELAY ON	0 seconds
Alarm Off Delay	DELAY OFF	0 seconds
Alarm Failsafe	FAILSAFE	OFF
Red LED	RED	ON
Flash rate	FLASH	ON
Alarm Message	MSG	ON
Message Text	MSG EDIT	ALARM 1
Timer Off Delay	OFF DELAY	1 minute
Timer On Time	ON TIME	1 second
Timer Mode	MODE	Continuous
Open Collector Output 2	OUTPUT 2	Disabled
Set Point	SET	40.00
Reset Point	RESET	30.00
Message Text	MSG EDIT	ALARM 2
Relay Output 1	RELAY 1	Disabled
Alarm	ALARM	Rate
Alarm Action	ACTION	AUTO
Set Point	SET	70.00
Reset Point	RESET	60.00
Alarm On Delay	DELAY ON	0 seconds
Alarm Off Delay	DELAY OFF	0 seconds
Alarm Failsafe	FAILSAFE	OFF
Red LED	RED	ON
Flash rate	FLASH	ON
Alarm Message	MSG	ON
Message Text	MSG EDIT	ALARM 3
Sample Count	TOTAL COUNT	1,000 gallons

Parameter	Display	Default Setting
Sample Time	TOTAL TIME	10 seconds
Batch Count	BATCH COUNT	Up
Batch Max	BATCH MAXIMUM	10,000
Batch Mode	BATCH MODE	Manual
Batch Preset	BATCH PRESET	1,000
Batch On Delay	DELAY ON	0 seconds
Batch Off Delay	DELAY OFF	0 seconds
Timer Off Delay	OFF DELAY	1 minute
Timer On Time	ON TIME	1 second
Timer Mode	MODE	Continuous
Relay Output 2	RELAY 2	Disabled
Set Point	SET	90.00
Reset Point	RESET	80.00
Message Text	MSG EDIT	ALARM 4
4-20 mA Output	4-20 mA	Rate

<b>Advanced Menu</b>		
Signal Conditioning Function	FUNCTION	Linear (2 pts)
Count Limit	COUNT LIMIT	8-Digit Total
Count Initial	COUNT INITIAL	0
Total Reset	TOTAL RESET	Enabled
GTot Reset	GTOT RESET	Disabled
Non-Resettable Grand Total	PERMLOCK	No
Low Cutoff	CUTOFF	Enabled: 0
Filter	FILTER	2.0 seconds
Filter Bypass	BYPASS	0.4 PCT
Main Password	MAIN	00000 (Unlocked)
Total Password	TOTAL	00000 (Unlocked)
GTot Password	GTOTAL	00000 (Unlocked)
Function Key 1	F1	Display
Function Key 2	F2	Reset
Function Key 3	F3	Acknowledge
Digital Input	DI	Reset Total
Hint Feature	HINT	Disabled
Totalizer	TOTAL	Enabled
Backlight	BACKLIGHT	Enabled
CapTouch	CAPT TOUCH	Normal

<b>Display Menu</b>		
Unit of Measure	UNITS	Rate: GAL/S Total: GAL
Decimal Point Location	DECP T	Rate: 2; Total: 1; Grand Total: 0
Comma	COMMA	Enabled
Top Display	TOP	Rate
Bottom Display	BOTTOM	Total

## Troubleshooting Tips

Certain sequences of events can cause unexpected results. To solve these issues, it is best to start fresh from factory defaults and use the manual as a step by step programming guide, rather than a random approach to programming. To reset the meter to factory defaults, see *Factory Default Settings* on page 78. In addition, for best results, we recommend using the free [MeterView XL](#) software for all programming needs.

Symptom	Check/Action
No display at all	Check: <ol style="list-style-type: none"> <li>The 4-20 mA current loop is providing at least 3.5 mA to the meter.</li> <li>The voltage drop of all devices connected to the 4-20 mA current loop does not exceed the max rating of the loop power supply.</li> </ol>
Not able to change setup or programming, <b>LOCKE</b> is displayed	Meter is password-protected. Enter correct five-digit password to unlock or Master Password of 50865.
Meter display flashes: <ol style="list-style-type: none"> <li>□□□□□</li> <li>..□□□□</li> </ol>	Check that the number of digits required for the scaled value does not exceed the maximum digits for the display. If it does, try adjusting the decimal point location for less precision or changing the PV display to the bottom display.
Display is unstable	Check: <ol style="list-style-type: none"> <li>Input signal stability and value.</li> <li>Display scaling vs. input signal.</li> <li>Filter and bypass values (increase).</li> </ol>
Display response is too slow	Check filter and bypass values
Display reading is not accurate	Check: <ol style="list-style-type: none"> <li>Input signal conditioner selected: Linear, square root, etc.</li> <li>Scaling or calibration</li> </ol>
Display does not respond to input changes, reading a fixed number	Check display assignment. It might be displaying max, min, or set point.
Display shows: <b>MAX, MIN, RATE, TOTAL,</b> or <b>GTOT</b> and a number	Display has been locked. Press <b>Enter</b> to unlock the display readings.
Relay operation is reversed	Check fail-safe settings in <i>Output</i> menu
Relays do not respond to signal	Check: <ol style="list-style-type: none"> <li>Relay action in <i>Output</i> menu</li> <li>Set and reset points</li> <li>Check manual control menu</li> </ol>
If the display locks up or the meter does not respond at all	Cycle the power to reboot the microprocessor.
CapTouch buttons do not respond	<ol style="list-style-type: none"> <li>If hand-symbol is flashing, multiple buttons were touch at the same time, wait a few seconds until the hand symbol goes off.</li> <li>If <i>Delayed</i> mode has been set, press &amp; hold any button for 5 seconds, the buttons should respond normally.</li> <li>If the slide switch on the display module is in the Lock position, move the switch to the Unlock position; see <i>Turning Off CapTouch Buttons</i> on page 26.</li> </ol>
Other symptoms not described above	Call Technical Support for assistance.

### Notes

---

---

---

---

---

---

---

---

---

---

---

---

---

---

---

---

---

---

---

---

---

---

---

---

---



# Complete Product Line of Loop-Powered Meters

## WITH ALL THE SAME FEATURES & FUNCTIONALITY



2 Open Collector Outputs



2 Solid-State Relays



4-20 mA Output



Two-Color Backlight

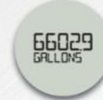

Dual-Line Displays



Pump Control



Batch Control



Ex CE IECEx

### LARGE DISPLAY

#### PD4 Loop Leader+ Series

- NEMA 4X, IP65 Rated Wall-Mount Enclosures
- Large 5-Digit, 2.8" High Top Display
- Safe Area and I.S. Models
- ATEX and IECEx Certified



SF Ex CE IECEx

### EXPLOSION-PROOF

#### PD6900 ProtEX+ Series

- NEMA 4X, IP68 Rated Aluminum and Stainless Steel Enclosures
- CapTouch Through-Glass Buttons
- Explosion-Proof & I.S.
- CSA, ATEX, and IECEx Certified



UL LISTED Ex CE IECEx

### 1/8 DIN PANEL MOUNT

#### PD6600 Loop Leader Series

- NEMA 4X, IP65 Rated Front 1/8 DIN Panel Mount Meters
- General Purpose and I.S. and N.I. Models
- UL, C-UL, and CE Approved

VantageView+ CE

### FIELD-MOUNT

#### PD6900 VantageView+ Series

- NEMA 4X, IP66 Rated Plastic Enclosure
- CapTouch Through-Window Buttons
- General Purpose



MeterView XL Software Programs All These Products

Go to [PREDIG.COM](http://PREDIG.COM) for details

## Contact Precision Digital

### Technical Support

Call: (800) 610-5239 or (508) 655-7300

Fax: (508) 655-8990

Email: [support@predig.com](mailto:support@predig.com)

### Sales Support

Call: (800) 343-1001 or (508) 655-7300

Fax: (508) 655-8990

Email: [sales@predig.com](mailto:sales@predig.com)

### Place Orders

Email: [orders@predig.com](mailto:orders@predig.com)

For the latest version of this manual please visit

[www.predig.com](http://www.predig.com)

### PRECISION DIGITAL CORPORATION

233 South Street • Hopkinton MA 01748 USA

Tel (800) 343-1001 • Fax (508) 655-8990

[www.predig.com](http://www.predig.com)

