



# Ultra 5

Instruction Manual



# Ultra 5 (FIFTH EDITION REV 1)

February 2021

Part Number M-180-4-005-1P

## **COPYRIGHT**

© Pulsar Measurement, 2005 -21. All rights reserved. No part of this publication may be reproduced, transmitted, transcribed, stored in a retrieval system, or translated into any language in any form without the written permission of Pulsar Process Measurement Limited.

## **WARRANTY AND LIABILITY**

Pulsar Measurement guarantee for a period of 2 years from the date of delivery that it will either exchange or repair any part of this product returned to Pulsar Process Measurement Limited if it is found to be defective in material or workmanship, subject to the defect not being due to unfair wear and tear, misuse, modification or alteration, accident, misapplication, or negligence.

## **DISCLAIMER**

Pulsar Measurement neither gives nor implies any process guarantee for this product and shall have no liability in respect of any loss, injury or damage whatsoever arising out of the application or use of any product or circuit described herein.

Every effort has been made to ensure accuracy of this documentation, but Pulsar Measurement cannot be held liable for any errors.

Pulsar Measurement operates a policy of constant development and improvement and reserves the right to amend technical details, as necessary.

The Ultra 5 shown on the cover of this manual is used for illustrative purposes only and may not be representative of the actual Ultra 5 supplied.

## **CONTACT**

For technical support, please contact:

Europe: [supporteurope@pulsarmeasurement.com](mailto:supporteurope@pulsarmeasurement.com)

Outside Europe: [supportnorthamerica@pulsarmeasurement.com](mailto:supportnorthamerica@pulsarmeasurement.com)

If you have any comments or suggestions about this product, please contact:

Europe: [europa@pulsarmeasurement.com](mailto:europa@pulsarmeasurement.com)

Outside Europe: [northamerica@pulsarmeasurement.com](mailto:northamerica@pulsarmeasurement.com)

Pulsar Measurement website: [www.pulsarmeasurement.com](http://www.pulsarmeasurement.com)

### **United States**

11451 Belcher Road South  
Largo,  
FL 33773  
888-473-9546

### **Canada**

16456 Sixsmith Drive  
Long Sault, Ont.  
K0C 1P0  
855-300-9151

### **United Kingdom**

Cardinal Building, Enigma  
Commercial Centre  
Sandy's Road, Malvern  
WR14 1JJ  
00 44 (0)1684 891371

**CONTENTS**

Chapter 1: Start Here.....	9
About this Manual .....	9
About the Ultra 5.....	10
Functional Description .....	11
How to use this Manual.....	12
Product Specification.....	13
EU Certificate of Conformity.....	15
Chapter 2 Ultra 5 Installation .....	16
Unpacking .....	16
Power Supply Requirements.....	16
Location .....	17
Dimensions .....	18
Wall Mount.....	18
Fascia Mount.....	20
Rack and Panel.....	22
Terminal connection details.....	24
Power .....	26
Transducer .....	26
Voltage selector and fuse location.....	29
Preparation for Operation .....	32
Maintenance .....	32
Chapter 3 How To Use Your Ultra 5.....	33
Operating the Controls.....	33
Run Mode.....	34
Program Mode.....	35
How to Access Program Mode.....	35
Hot Keys.....	37
Menu Keys .....	38
Numeric Keys.....	38

Using the Menu System .....	39
Directly Editing Parameters.....	40
Test Mode .....	41
Using the Serial Interface.....	42
Parameter Defaults.....	44
Chapter 4 Ultra Wizard.....	45
Enter Program Mode.....	45
Choose Ultra Wizard.....	45
Level/Volume.....	46
Pump.....	46
Flow .....	47
Chapter 5 Level / Volume.....	48
Quick Setup .....	50
Example 1 Level Monitoring with Alarms.....	55
Example 2 Level Monitoring and Control (up or down).....	57
Example 3 Volume Application.....	59
Chapter 6 Pump.....	62
Quick Setup Menu.....	64
Example 1 Level Monitoring with Alarms.....	70
Example 2 Sump Control (pump down).....	72
Example 3 Reservoir Control (pump Up).....	74
Example 4 Differential Control.....	76
Chapter 7 Flow.....	78
Exponential Devices .....	85
Calculations .....	88
BS3680 Flumes (P700 = 2).....	92
Rectangular Flume Calculations.....	93
U-Throated Flume Calculations.....	94
Example 2 BS3680 U-Throated Flume.....	95
BS3680 Weirs (P700 = 3).....	97
Rectangular Weir Calculations.....	97

V-Notch Weir Calculations .....	98
BS3680 Rectangular Broad Crested Weir .....	101
Rectangular Broad Crested Weir Calculations .....	101
Velocity Area .....	103
Calculations .....	104
Round Pipe .....	106
Special Devices.....	107
Palmer Bowlus and H-Flume Calculations .....	108
V-Notch Angle Weir (Non-BS 3680) Calculations.....	109
Universal Calculations (P700=6).....	109
Chapter 8 Parameter Guide .....	110
Menu System .....	110
Top Level Menu .....	110
Application Menu.....	111
Relays Menu.....	112
Data Logs Menu .....	113
Volume: Available when Ultra Wizard = Volume.....	114
OCM: Available when Ultra Wizard = OCM .....	115
Display Menu .....	116
mA Output Menu.....	117
Compensation Menu .....	117
Stability Menu .....	118
Echo Processing Menu.....	118
System Menu .....	119
Device Comm Menu .....	120
Test Menu .....	121
Application Parameters.....	122
Operation .....	122
Dimensions .....	125
mA Input.....	127

Relay Parameters ..... 128

Alarms ..... 130

General Control ..... 134

Pumps ..... 135

Control ..... 139

Miscellaneous ..... 145

Pump by Time ..... 147

Common Relay parameters ..... 150

Pump "Advanced" Parameters ..... 151

Pump Run On ..... 151

Starting ..... 151

Stopping ..... 152

Pump Exercising ..... 152

Wall Cling ..... 153

Storm ..... 153

Data Log parameters ..... 155

Totaliser Audits ..... 155

Temperature ..... 155

Pump Logs ..... 156

Pumped Volume ..... 157

Volume ..... 159

Conversion ..... 159

Breakpoints ..... 164

Tables ..... 165

Pump Efficiency ..... 166

OCM Parameters ..... 169

Dimensions ..... 173

Calculations ..... 178

Velocity ..... 178

Breakpoints ..... 179

Tables ..... 180

Average Flow .....	180
Display Parameters .....	181
Options.....	181
Failsafe.....	182
Auxiliary.....	183
Totaliser.....	185
mA Output Parameters.....	188
Range.....	188
Operation .....	189
Setpoint.....	189
mA Limits.....	190
mA Trim .....	190
mA Failsafe.....	191
Compensation Parameters .....	192
Offset.....	192
Temperature.....	192
Velocity.....	193
Stability Parameters .....	194
Damping .....	194
Indicator.....	194
Rate.....	194
Filters.....	195
Echo Processing Parameters.....	196
Transducer 1 Status.....	196
Transducer 2 Status.....	197
DATEM Parameters.....	198
System Parameters .....	199
Passcode .....	199
Backup .....	199
System Information .....	200

Date & Time .....201

LED Colour .....201

Watchdog.....202

Daylight Saving Time.....203

Device Comm. ....207

RS232 Set Up .....207

RS 485 Set Up .....207

Remote Alarm.....208

Test Parameters .....210

Simulation .....210

Hardware .....211

Chapter 9 Troubleshooting.....213

Chapter 10 Disposal.....214

Notes .....215



## CHAPTER 1: START HERE...

Congratulations on your purchase of a Pulsar Ultra 5. This quality system has been developed over many years and represents the latest in high technology ultrasonic level measurement and control.

It has been designed to give you years of trouble-free performance, and a few minutes spent reading this operating manual will ensure that your installation is as simple as possible.

### *About this Manual*

**It is important that this manual is referred to for correct installation and operation.** There are various parts of the manual that offer additional help or information as shown.

### *Tips*



TIP: Look for this icon throughout your Pulsar Measurement manual to find helpful information and answers to frequently asked questions.

### *Additional Information*

#### **Additional Information**

At various parts of the manual, you will find sections like this that explain specific things in more detail.

### *References*

#### **— See Also**

References to other parts of the manual.

### About the Ultra 5

**Ultra 5** is a brand-new concept in ultrasonic level measurement. Within its memory are all the functions and settings of three different and separate ultrasonic devices.



The Ultra 5 does not offer a multiple range of functions blended together which lead to complicated calibration and a compromise to the specification, Ultra 5 is the first ever system to offer the ability to dedicate the functionality of the unit to any of three specific duties i.e. level or volume measurement, pump control, or flow measurement.

The benefits are many but most importantly the unit provides:

1. A most versatile system which is quickly configurable to offer anyone three separate functions within seconds. Ideal for simplicity of purchase and off the shelf spares.
2. A totally dedicated device with the ability to perform all aspects of the task required i.e. no compromise in specification.
3. Easy to set up using the unique "Quick Set Up" Menu. To calibrate, first set the Ultra Wizard for the desired task, and then refer to the relevant chapter in this manual that relates to your application:

**Chapter 5** for **Level** or **Volume**,

**Chapter 6** for **Pump Control**

**Chapter 7** for **Flow**

### **Functional Description**

Ultra 5 sends a transmit pulse to the transducer, which emits an ultrasonic pulse perpendicular to the transducer face, and the returned echo is sent back to the Ultra 5. The time taken to receive the echo is measured and the distance from the transducer face to the surface being monitored is calculated.

Ultra 5 can measure from zero to 50m from the face of the transducer to the surface being monitored, dependent on the application chosen and transducer used.

The relays can be programmed to activate alarms, pump starters, or other control equipment. There is an isolated 4-20 mA output that can be connected to a recorder or PLC, to monitor, depending on application chosen, **level, space, distance, OCM head, OCM flow or volume**, independently from that shown on the display. There is an RS232 port, so that the Ultra 5 can be operated remotely by a PC or other equipment.

Ultra 5 can be programmed either by the built-in keypad (standard on all wall and fascia units), or by PC via the RS 232 Serial Interface (optional). The optional rack and panel mounted units are programmed with the Remote Communicator, and one Communicator can program many Pulsar Ultra 5 units. All parameters are stored in non-volatile memory, so are retained in the event of power interruption. A second backup copy of all parameters can also be retained in the Ultra 5 memory, in case an alternative set of parameters needs to be stored.

Three user definable control relays with individual setpoints and intelligent performance logging software features ensure maximum control versatility.

The system utilises the unique DATEM software (**D**igital **A**daptive **T**racking of **E**cho **M**ovement). This is a proven digital mapping technique developed especially for the Pulsar Ultra range, which gives the system unequalled ability when identifying the "true target level" in the face of competing echoes from pipes, pumps, or other obstructions. Coupled with the powerful, long-range abilities of the 'all new' dB transducer range, the Ultra 5 lives up to its reputation as the most reliable ultrasonic level measurement system available.

The Pulsar Ultra 5 ultrasonic level controller has been designed to provide maintenance-free fit and forget performance.

**How to use this Manual**

1. Read the **installation** and **operating** instructions contained in, **Chapters 2** and **3**, carefully, they are applicable in every use of this product.
2. Decide which “task” you wish your Ultra 5 to perform for you and then configure the unit using “**Ultra Wizard**” as described in **Chapter 4**.
3. Move directly to the appropriate chapter of this manual, as listed below, for details on how to program Ultra 5 using the “Quick Set Up” Menu.

CHAPTER	DUTY / TASK
<a href="#">Chapter 5 Level/Volume</a>	Measurement of Level or Volume
<a href="#">Chapter 6 Pump</a>	Control of Pumps
<a href="#">Chapter 7 Flow</a>	Measurement of Open Channel Flow

## Product Specification

### PHYSICAL

<b>Wall Mount outside Dimensions</b>	235 x 184 x 120 mm
<b>Weight</b>	Nominal 1kg
<b>Enclosure Material/Description</b>	Polycarbonate flame resistant to UL91
<b>Cable entry detail</b>	10 cable entry knockouts, 1 x M16 underside, 5 x M20, 4 x 18mm dia (PG11) at rear.
<b>Fascia Mount outside dimensions</b>	200 x 112 x 108mm
<b>Weight</b>	1.3kg
<b>Enclosure material/description</b>	Stainless steel back, Polycarbonate UL94-V0 front and bezel
<b>Rack Mount</b>	10HP x 160mm (6.3") deep x 3U (128.5mm / 5.05") high
<b>Enclosure/material description</b>	Aluminium frame
<b>Panel mount</b>	72 wide x 144 high x 176mm deep
<b>Transducer Cable Extensions</b>	2-core screened
<b>Maximum Separation</b>	1000m (3,280 ft), 500m (1,640 ft) for mmWave

### ENVIRONMENTAL

<b>IP Rating (Wall)</b>	IP65
<b>IP Rating (Fascia)</b>	IP64
<b>Optional IP rated panel mount</b>	IP65
<b>Max. &amp; min. temperature (electronics)</b>	-20 °C to +50 °C
<b>Flammable atmosphere approval</b>	Safe area: compatible with approved dB transducers (see transducer spec' sheet)
<b>CE Approval</b>	See EU Declaration of Conformity

### PERFORMANCE

<b>Accuracy</b>	0.25% of the measured range or 6 mm (whichever is greater). mmWAVE $\pm$ 2mm.
<b>Resolution</b>	0.1% of the measured range or 2 mm (whichever is greater)
<b>Max. Range</b>	Dependant on transducer (maximum 50m dB50)
<b>Min. Range</b>	Dependent upon application and transducer (minimum zero dB Mach3)
<b>Rate Response</b>	Fully adjustable

### ECHO PROCESSING

<b>Description</b>	DATEM (Digital Adaptive Tracking of Echo Movement)
--------------------	--

**ANALOG INPUT**

<b>Available as an option 0-20 or 4-20mA</b>	Isolated (floating) input (to 150V) 4-20mA or 0-20 mA source, open circuit voltage 33V, 22V at 4mA, 14V at 20mA (user programmable and adjustable) 0.1% resolution
--	--

**OUTPUTS**

<b>Analogue I/O</b>	Isolated (floating) output (to 150V) of 4-20 mA or 0-20 mA into 500Ω (user programmable and adjustable) 0.1% resolution
<b>Digital output</b>	Full Duplex RS232
<b>Volt free contacts, number, and rating</b>	5 form "C" (SPDT) rated at 5A at 240V AC
<b>Display</b>	6 digits plus 12-character text, plus bar graph with direction indicators, remote communicator identifier, and program/run/test mode indicators

**PROGRAMMING**

<b>On-board programming</b>	By integral keypad
<b>PC programming</b>	Via RS232
<b>Remote programming (Rack and panel option only)</b>	By optional infra-red communicator
<b>Programming security</b>	Via passcode (user selectable and adjustable)
<b>Programmed data integrity</b>	Via non-volatile RAM, plus backup

**SUPPLY**

<b>Power Supply</b>	115VAC +5% / -10% 50/60 Hz, 230VAC + 5% / -10% 50/60 Hz, DC 18 - 30V 10W maximum power (typically 6W)
<b>Fuses</b>	100mA at 170-240V AC (fitted as standard to wall units) 200mA at 85-120V AC (fitted as standard to fascia units)

**REMOTE COMMUNICATOR**

<b>Batteries</b>	2 x AA alkaline batteries. Do not use NiCad's
------------------	---

Pulsar Measurement operates a policy of constant development and improvement and reserve the right to amend technical details, as necessary.

**EU Certificate of Conformity****EU DECLARATION OF CONFORMITY****PULSAR *Ultra controllers range***

This declaration of conformity is issued under the sole responsibility of the manufacturer

Relevant directive(s)	2014/30/EU - EMC directive and its amending directives. 2014/35/EU - Low Voltage directive and its amending directives. 2011/65/EU - RoHS directive and its amending directives.
Manufacturer's name	Pulsar Process Measurement Ltd.
Manufacturer's address	Cardinal Building, Enigma Business Commercial Centre, Sandy's Road, Malvern, Worcestershire, WR14 1JJ, UK.
Apparatus	System controller with optional communications.
Models	Pulsar Ultra wall mount, including Ultra 3, Ultra 5, Advanced rake master 2.2, Oracle CSO 2.1, Ultra 3 i.s. . Pulsar Ultra Fascia mount including Ultra 3, Ultra 5, Quantum, Zenith. Pulsar Ultra 4, wall & fascia mount. Ultra Lite, wall & fascia mount. Pulsar Ultra rack mount. Pulsar Ultra Twin, wall & fascia mount.
Type of equipment	Measurement and process control.
Standards applied	EN 61010-1:2010+A1:2019 Safety requirements for electrical equipment for measurement, control and laboratory use. EN 61326-1:2013 EMC, equipment class industrial.

I declare that the apparatus named above has been tested and complies with the relevant sections of the above referenced standards & directives.

Signed for and on behalf of:

A handwritten signature in black ink, appearing to read "Tim Brown".

Date: 7th April 2021.

Rev. 5.0.

Name & function: Tim Brown, electronics engineer.

Pulsar Process Measurement Ltd.

## CHAPTER 2 ULTRA 5 INSTALLATION

### *Unpacking*

#### **Important Information**

All shipping cartons should be opened carefully. When using a box cutter, do not plunge the blade deeply into the box, as it could potentially cut or scratch equipment components. Carefully remove equipment from each carton, checking it against the packing list before discarding any packing material. If there is any shortage or obvious shipping damage to the equipment, report it immediately to Pulsar Process Measurement Limited.

### *Power Supply Requirements*

Ultra 5 can operate from AC supply or from a DC battery. The **AC** is either **115V +5%/-10% 50/60Hz** or **230V +5%/-10% 50/60Hz**, depending on the position of the selector switch. The **DC** is **18-30V**. In all cases the Ultra 5 will typically consume 6W of power, with a maximum of 10W.



## Location

The Ultra 5 must be mounted in a non-hazardous (safe) area, and the transducer fitted in the hazardous area.

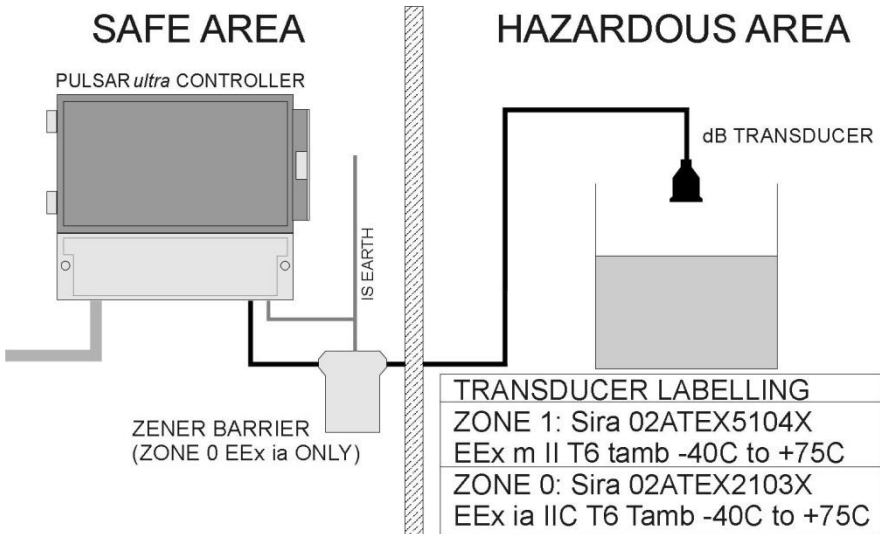

When choosing a location to mount the enclosure, bear in mind the following:

- Ensure that the Ultra 5 is installed in a "Safe", non-hazardous area.
- For a clear view of the LCD display, it is recommended that it is mounted at eye level.
- The mounting surface is to be vibration free.
- The ambient temperature is between -20°C and 50°C.
- There should be no high voltage cables or inverters nearby,

### Important Information

All electronic products are susceptible to electrostatic shock, so follow proper grounding procedures during installation.

**Dimensions**

**Wall Mount**

The dimensions of the wall fixing holes are as shown below:

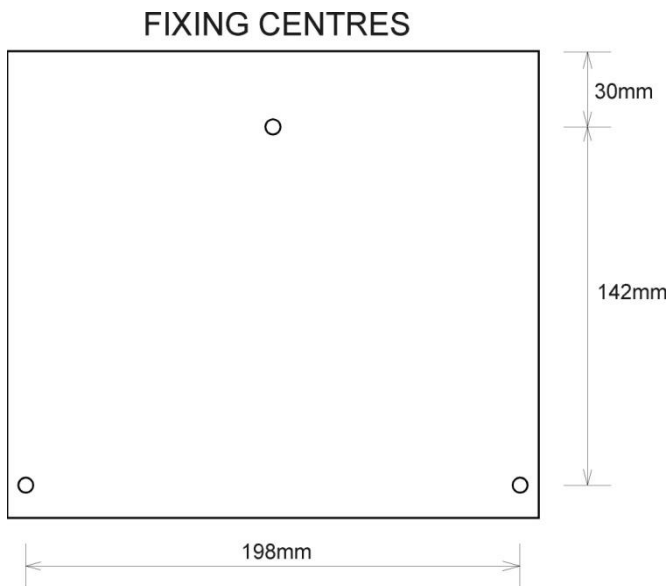

The Ultra 5 should be mounted by drilling three holes suitable for size 8 screws (length to suit your application) and fixing the top screw in place. Hang the unit on this and fix the two remaining screws by removing the terminals access cover to access the pre-drilled holes.

The full dimensions (in mm) of the enclosure are as shown below:

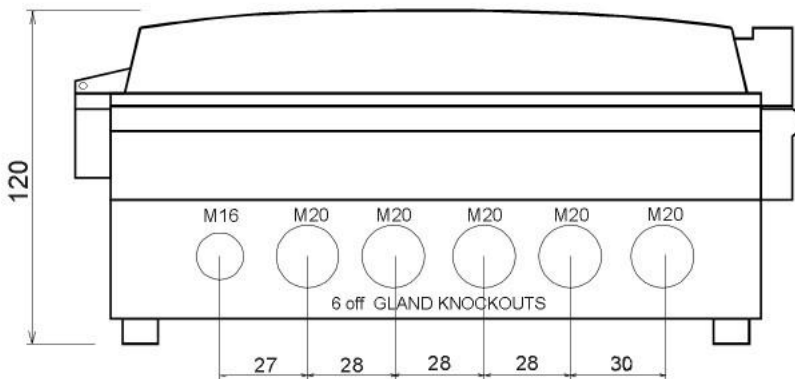
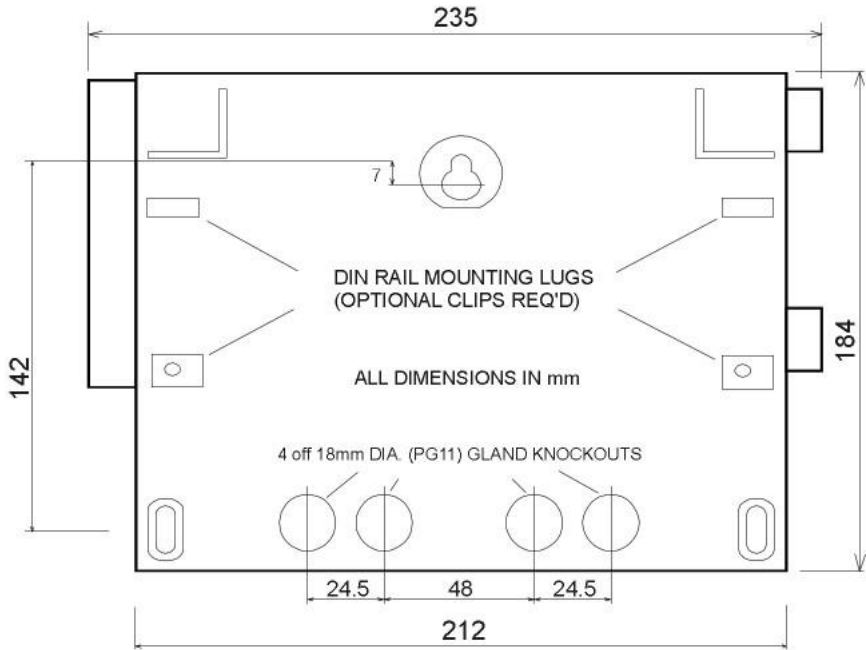

### Cable entry

There are 6 cable gland knockouts on the base of the wall mount Ultra 5 (1 x M16, 5 x M20) and 4 on the rear (4 x 18mm dia.) (PG11). Select which ones you wish to use, and remove them by using a circular cutter, such as a tank cutter. Take care not to damage the circuit board inside whilst undertaking this. Do not use a hammer, as this may cause damage to the enclosure.

It is recommended that you use suitable cable glands to ensure that the ingress rating is maintained.

### Fascia Mount

The dimensions of the wall fixing holes are as shown below:

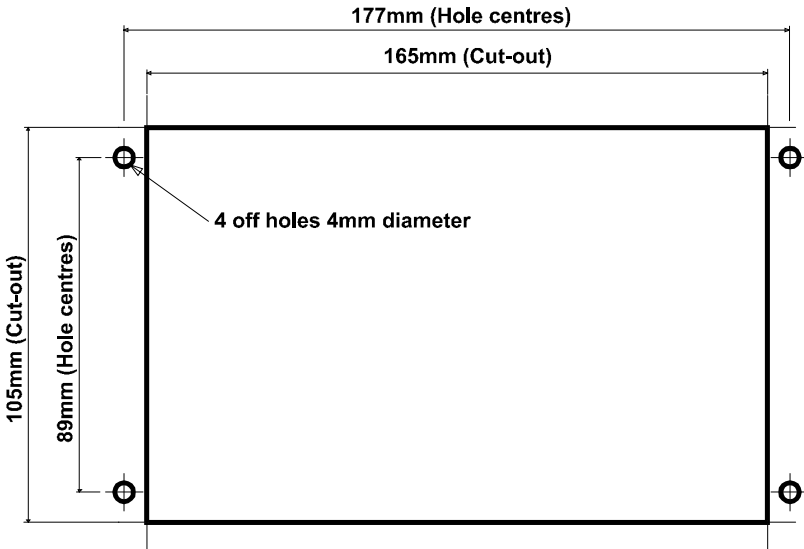

The full dimensions of the fascia mount enclosure are as shown below:

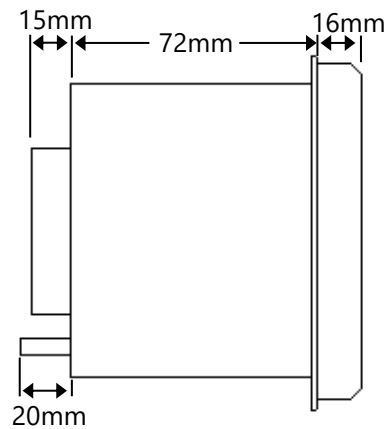
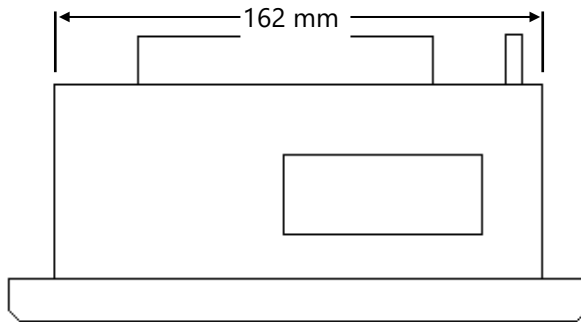
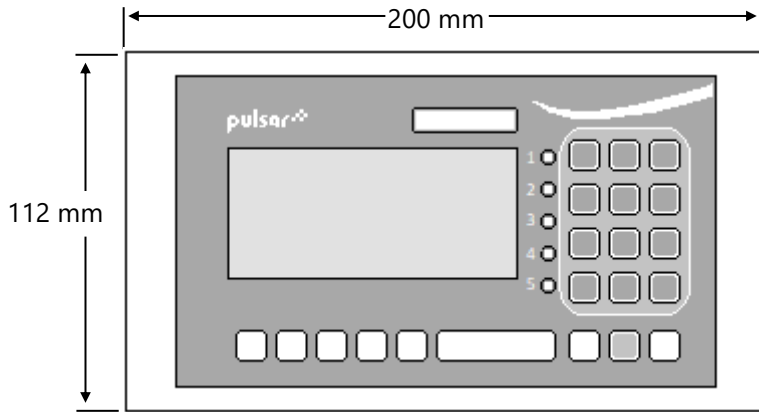

### Rack and Panel

The Ultra 5 rack mount unit is a standard 10HP plug in unit, for a standard 84HP (19"), 160 mm sub rack unit.

The connector that is supplied with the rack unit should first be fitted to the back of the sub rack, so that when the rack unit is inserted into the rack, it connects correctly. To install the unit into the sub rack, slide the Ultra 5 into the rack and secure by tightening the four-captivated screw that are in the faceplate.

The panel mount unit should be installed by cutting a hole of size  $DIN\ 68^{+0.7}$  x  $138^{+1.0}$  mm in the panel, then insert the Ultra 5 enclosure through the hole, and tighten the fixing screws from the rear. Make sure you leave sufficient room for the cables behind the enclosure (a depth of at least 225 mm behind the panel should suffice).

Dimensions of the rack enclosure are as shown below:

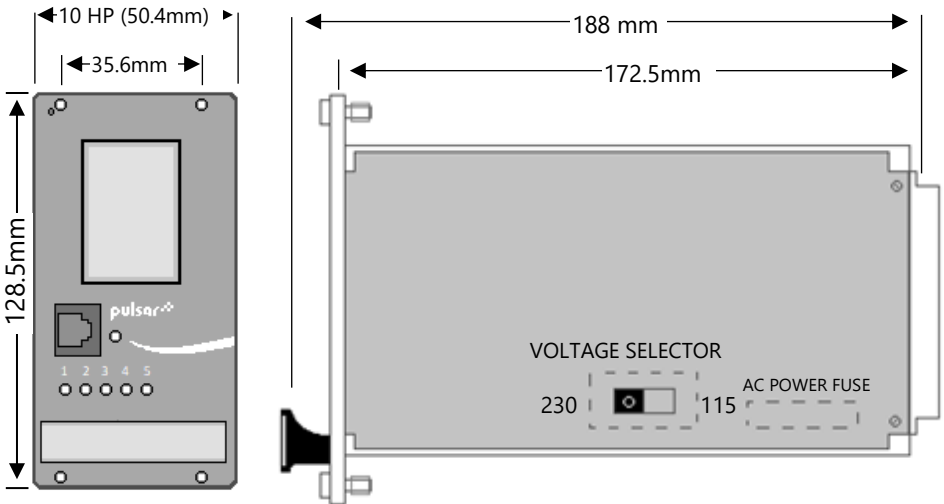

Dimensions of the panel enclosure are as shown below:

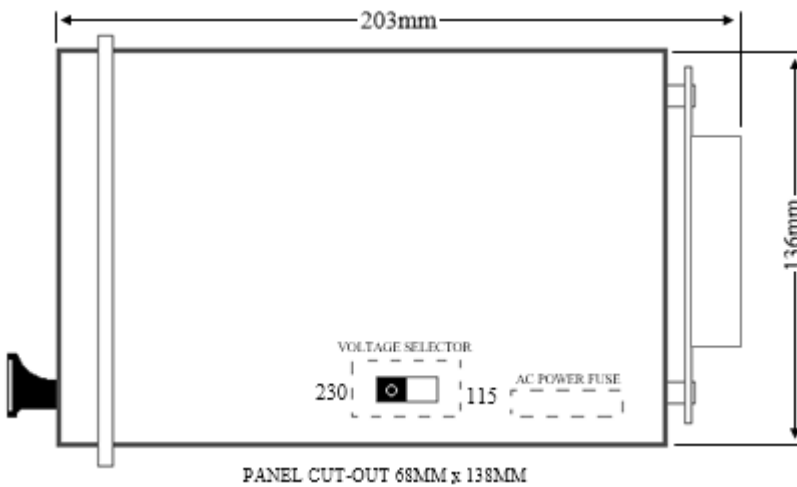
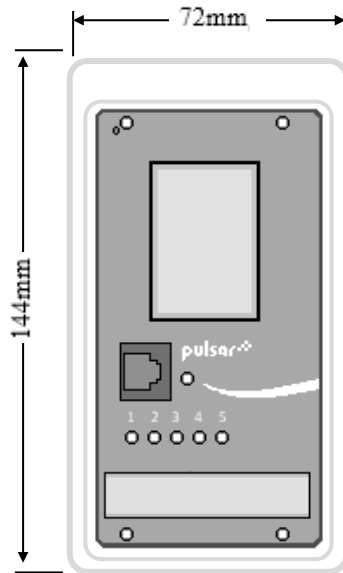





The terminal details are as illustrated below. There is also a wiring diagram on the side of each unit.

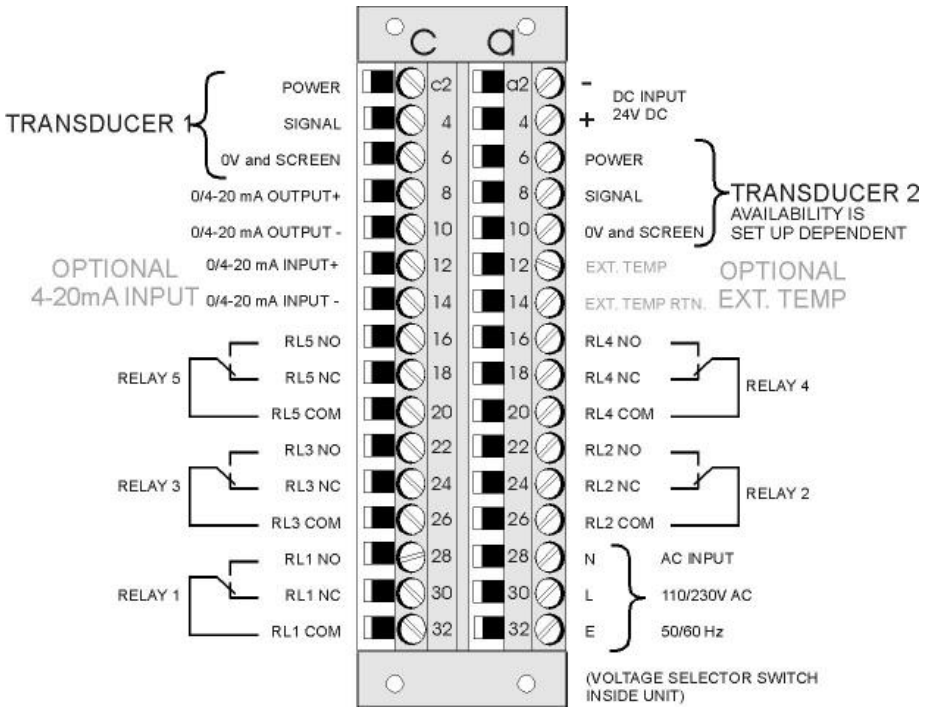

**Power**

The Ultra 5 can operate from mains AC and automatically from DC or battery backup in the event of power failure or can be operated permanently from DC or batteries.

**Transducer**

The transducer should be installed, and connected, in accordance with the installation instructions contained in the Transducer User Guide. Wire the transducer to the Ultra 5's transducer terminals, as follows:

*Transducer 1*

<b>TERMINAL CONNECTION DETAILS</b>				
Unit Type	Red: Power	White: Signal	Black: 0Volts	Green: Screen
Wall Mount	39	40	41	41
Fascia Mount	32	31	30	30
Rack or Panel	C2	C4	C6	C6

*Transducer 2*

<b>TERMINAL CONNECTION DETAILS</b>				
Unit Type	Red: Power	White: Signal	Black: 0Volts	Green: Screen
Wall Mount	42	43	44	44
Fascia Mount	32	31	30	30
Rack or Panel	C2	C4	C6	C6

When using 2-core screened extension cable, the Black and Green wires of the transducer should be connected to the screen of the extension cable which in turn should be connected to the appropriate 0 volts' terminal of the Ultra 5.

For **Zone 1** applications a transducer certified to **Sira 02ATEX5104X** is used, and must be supplied via a 4000A breaking fuse, which is fitted as standard to the Ultra 5.

For **Zone 0** a transducer certified to **Sira 02ATEX2103X** is used, which must be connected to the Ultra 5 controller via an external Zener barrier.

See transducer label for certification details.

**Single Transducer** mode is used to measure space, level, distance, volume or flow and the transducer should be connected to Transducer 1 input terminals.

**Dual Transducer** mode is used to measure **Differential** and **Average**. For **Differential**, the **upstream** transducer should be **connected to Transducer 1** input terminal and the **downstream** transducer to **Transducer 2** input terminal. In cases where the Ultra 5 is required to measure **Average**, then transducers can be **connected to either one**.

#### *Relay Outputs*

The five relays can be programmed for a variety of alarms, pump control, or other process functions. The relay contacts are all rated at 5A at 240V AC. All connections should be such that the short circuit capacity of the circuits to which they are connected, is limited by fuses rated so that they do not exceed the relay rating.

#### *Current Output*

This is an isolated (floating) mA output (to 150 V), of 4 - 20mA or 0 - 20mA, and the load should not exceed 500  $\Omega$ .

#### *Current Input (Optional)*

This feature is available as an option only. Please consult Pulsar for further details. The current input is an isolated (floating) mA input (to 150 V), 4 - 20mA or 0 -20mA.

#### *Temperature Input (Optional)*

The external temperature sensor allows more localised compensation of the measured distance due to changes in temperature.

There are two models, Type A and Type B as follows:

TYPE	RANGE
A	-25° to 50°C
B	-25° to 125°C

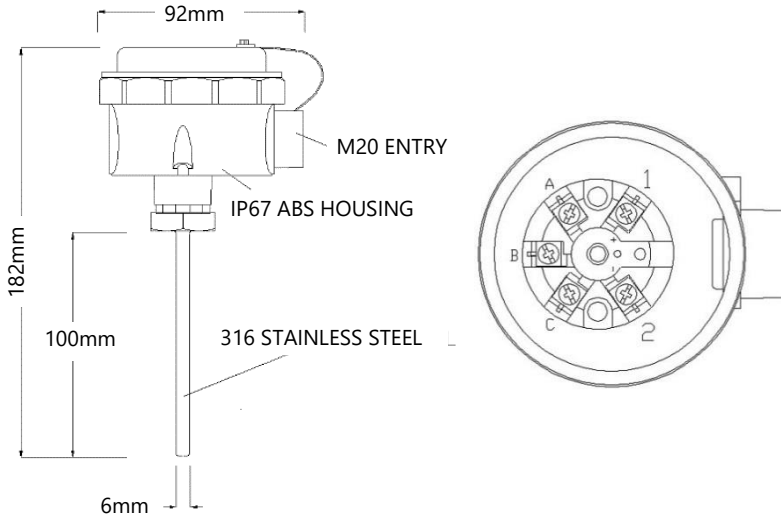

*RS2323 Serial Interface*

If required, you can connect to the serial interface to operate your Ultra 5 remotely.

The Temperature sensor connections are as follows:

DESCRIPTION	TEMPERATURE SENSOR	ULTRA 5 WALL	ULTRA 5 RACK & PANEL	ULTRA 5 FASCIA
Power Supply	Terminal 1	Terminal 29	Ternal a12	Terminal 25
Return	Terminal 2	Terminal 28	Terminal a14	Terminal 24

**Temp Source** (P852), should be set to option 4 or 5 depending on the sensor range, set 4 for type A and 5 for type B (see above), the range is specified on the label of the sensor.

**Voltage selector and fuse location**

*Wall Mount*

The voltage selector switch and mains fuse is located, inside the terminal compartment, to the left of the mains terminals, as illustrated below.

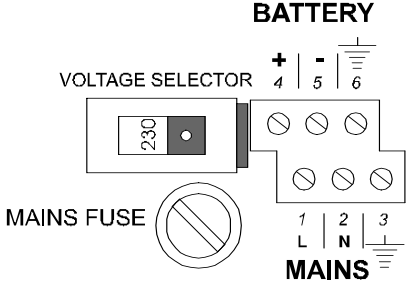

*Fascia Mount*

The voltage selector switch and mains fuse, is located under the removable cover at the bottom of the unit, as illustrated below.

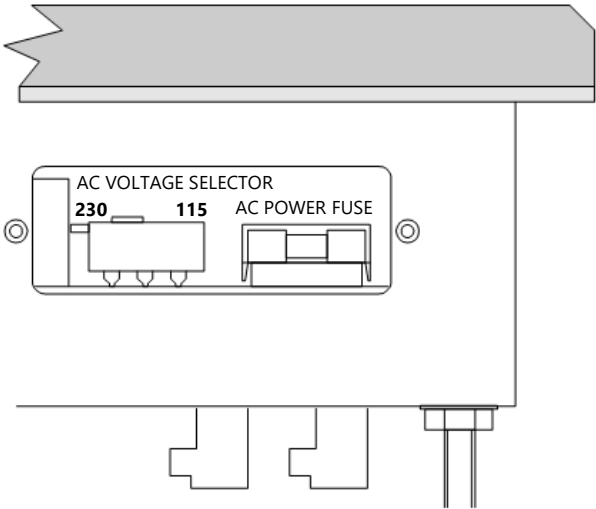

*Rack and Panel mount*

The voltage selector switch and mains fuse, is situated on the inside of the bottom PCB, as illustrated below, and can be accessed from the lower side of the rack unit.

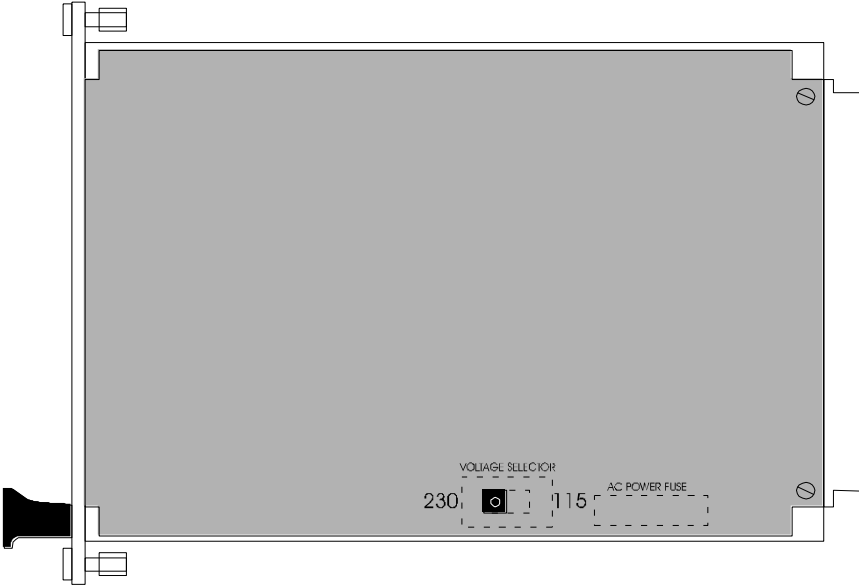

### Important Information

The rear metal case of the fascia unit must be connected to earth via the earthing stud located on the rear of the unit, see drawing above, using wiring to meet local requirements.

Before applying AC power (mains), make sure you have correctly selected the voltage selector switch, as detailed in the preceding pages.

Please note that all Fascia units are set to 115 volts AC with a 200mA fuse fitted, and all Wall units are supplied set to 230 volts AC for safety reasons, and a 100mA fuse fitted as standard.

Never operate the Ultra 5 with terminal access exposed.

An external switch or circuit breaker should be installed near to the Ultra 5 to allow the supply to be removed during installation and maintenance. In addition, the relay contacts should also have a means of isolating them from the Ultra 5.

Interconnecting cables must be adequately insulated in accordance with local regulations. Strip back 30 mm of the outer insulation of the cable. Strip 5 mm of insulation from the end of each conductor. Twist all exposed strands of the conductor together. Insert the stripped conductor into the terminal block as far as it will go and tighten the terminal block screw. Ensure that all strands are firmly clamped in the terminal block and that there is no excess bare conductor showing, and no stray strands.



#### **DON'T FORGET**

**Make sure you move the voltage selector switch to the correct position for your power supply**

### Important Information

If the equipment is installed or used in a manner not specified in this manual, then the protection provided by the equipment may be impaired.

## **Preparation for Operation**

Before switching on, check the following:

- ✓ The Ultra 5 is mounted correctly and is in a 'safe' area.
- ✓ The power supply is correctly installed.
- ✓ The voltage selector switch is in the correct position.
- ✓ The relays are connected correctly.

## **Maintenance**

There are no user serviceable parts inside Ultra 5, except the mains fuse. If you experience any problems with the unit, then please contact Pulsar Measurement for advice.

To clean the equipment, wipe with a damp cloth. Do not use any solvents on the enclosure.

### **Important Information**

The unique DATEM software comes into operation as soon as power is applied and is designed to monitor a **moving level** or **target** with the **transducer** in a **fixed position**.

If, after any period of use, it should become necessary to move the transducer, for any reason, from its original operating position, switch off the Ultra 5, before proceeding, in order to prevent any undesirable updates to the DATEM trace. If after moving the transducer the reading is not as expected, please refer to [Chapter 9 Troubleshooting](#).



## CHAPTER 3 HOW TO USE YOUR ULTRA 5

### Operating the Controls

#### Display

The display provides information on the current mode of operation, and status of the remote communication. Whilst in the Run Mode it will display the current level reading and its units of measure, along with status messages with regards to the Transducer, Echo reception and Fail-Safe Mode. Additionally, it can be programmed to provide status messages on alarms, pumps etc. When in the Program mode the display is used to read information on the Menu System, Parameter Number and parameter details and values, which can be entered. During Test Mode, the display is used to monitor the simulated level. A bar graph is also provided which will provide a visual reading of the level, in percentage of span.

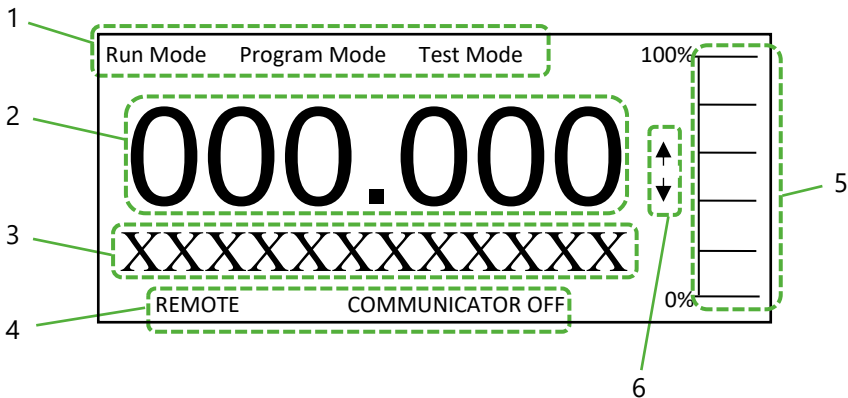

1. Displays the current mode of operation
2. Main 6-digit display:
  - Run Mode;** current measurement displayed, dependent on mode and measurement units chosen, and value of hotkey selected.
  - Program Mode;** displays parameter number and values entered for parameters.
  - Test Mode;** displays simulated level.

3. Auxiliary Display, scrolling twelve-digit display.  
**Run Mode;** displays measurement units, status messages on signal and transducer, details of Hot Key function selected. It can be also programmed to provide notification messages on alarms and pumps etc. For full details please refer to Display Parameters in the relevant parameter listing.  
**Program Mode;** displays menu and sub menu headings, parameter details and options.
4. Communicator status, this displays the status of remote PC connection and velocity sensor operation.
5. Bar graph display, this gives visual indication of measurement in % of span.
6. Level indicators:  
**Run Mode;** indicates in which direction the level is moving.  
**Program Mode;** indicates at which level of the menu system you are at.

There are two main operating modes for your Ultra 5, **Run Mode** and **Program Mode**. There is also a **Test Mode**, used for checking the set-up. All modes are now described.

### **Run Mode**

This mode is used once the Ultra 5 has been set up in program mode. It is also the default mode that the unit reverts to when it resumes operation after a power failure.

When the Ultra 5 is switched on for the first time, it will display, in metres, the distance from the transducer face to the target. All relays by default are switched off.

After programming is complete, any relays that are set will operate when the level reaches the relevant setpoint, and the LED's will change colour (unless specifically switched off).

## Program Mode

This mode is used to set up the Ultra 5 or change information already set. You must use either the built-in keypad (standard) or, alternatively the unit can be set up with a PC via the RS232 Serial Interface.

Entering a value for each of the parameters that are relevant to your application provides all the programming information.

### How to Access Program Mode

#### Wall and Fascia mount

To enter program mode on the Ultra 5, you simply enter the passcode, via the keypad, followed by the ENTER key. The **default passcode** is **1997**, so you would press the following:



#### Rack and Panel

The Remote Communicator is used to program the rack and panel version of the Ultra 5. Before you can commence programming, it is first necessary to activate the communication between the Ultra 5 and the Communicator. This is achieved by offering the Remote Communicator up to the Ultra 5 so that the arrow point in the Pulsar Logo on the Communicator is in line with the corresponding arrow point on the front panel of the unit and lightly 'touching' the unit with the communicator (see following figure).

Confirmation that communication has been successfully achieved will be indicated by a change of the Communicator status display, at the bottom of the LCD from "Communicator Off" to "Remote Communicator On". Once communications have been activated the Remote Communicator can be used up to 1 metre away from the unit but should be 'aimed' at the unit whilst entering information.

On returning the unit to Run Mode ensure that communications between the Remote Communicator and the Ultra 5 are switched off by once again 'touching' the unit with the Communicator and confirm the display status changes back to "Communicator Off"

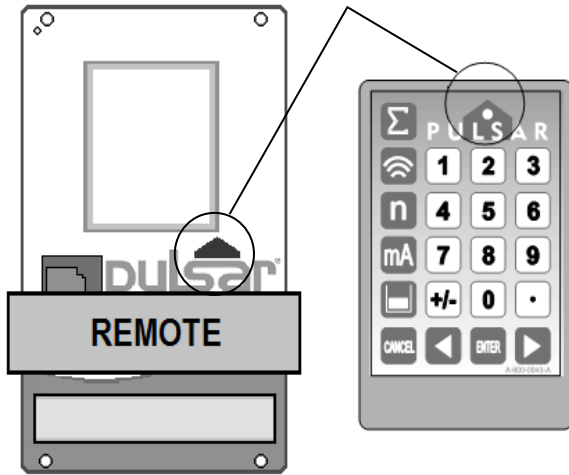

Once communications have been activated, you simply enter the passcode, via the keypad, followed by the ENTER key. The **default passcode** is **1997**, so you would press the following:









### Important Information

There is a time-out period of 15 minutes when in program mode. After which time the run mode will resumed if you do not press any key.





## Hot Keys

There are five hot keys on the keypad, which can be used to quickly access common parameters for viewing only, while in Run Mode. Pressing the hot key once will display the first parameter, then repeated pressing will display the others, then the Ultra 5 reverts to Run Mode. In program mode, they have different functions, the functions are shown below.

HOT KEY	RUN MODE	PROGRAM MODE
	When application is Flow, view non-resettable totaliser. View and reset the resettable totaliser. When application is Pump, view total pump running hours and individual pump running hours.	Not used with Ultra 5
	Displays echo confidence, echo strength, height above loss limit (HALL), average noise, peak noise, and temperature	Not used with Ultra 5
	When application is Pump, view total number of pump starts and individual pump starts.	Reset parameter to default setting
	Instantaneous mA output	Not used with Ultra 5
	Dependent on application. Displays distance, level, space, volume or rate of change of level.	Toggle relay setpoints between units of measure and % of span.
	Not used with Ultra 5	Takes you to the last parameter edited when you first enter program mode.
	Shows details of function type, firmware revision and serial number	Enter decimal point.

### Menu Keys

The menu keys have the following functions:

HOT KEY	FUNCTION
 	<ol style="list-style-type: none"> <li>1) Arrow keys for moving left and right around the menu system.</li> <li>2) Used in test mode to simulate the level moving up and down.</li> </ol>
	<ol style="list-style-type: none"> <li>1) Used to confirm each action (e.g. select a menu option)</li> <li>2) Used to confirm questions asked by the Ultra 5, such as before restring factory defaults.</li> </ol>
	<p>Used to navigate up a level in the menu system, and back to run mode.</p> <p>Used to cancel a value entered in error</p>

### Numeric Keys

These keys are used for entering numerical information during programming.

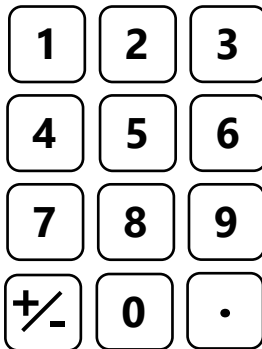

There are two means of editing parameters, directly or using the menu system. Each is now described.

### Using the Menu System

The menu system has been designed to make the changing of parameters very simple. There are two levels of menu: **Main Menu** and **Sub Menu**.

On the display, there is a line of text that displays the menu system. Pressing the arrow keys scrolls the display between the top-level menu items, (as the example shown below, starting at Quick Setup).

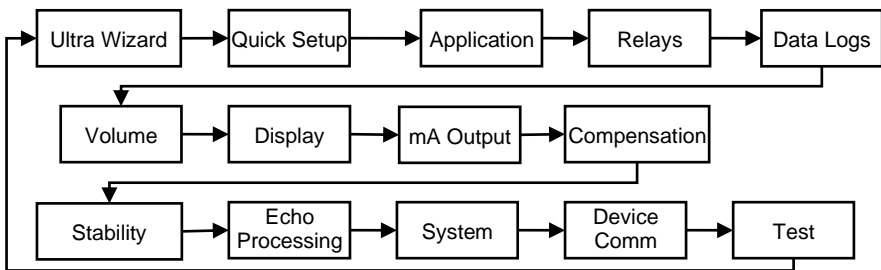

As you press the cursor keys to scroll left and right between these, you can press ENTER at any time, to select the desired menu heading, and take you to the sub-menu.

Each of these options, along with their sub-menus, are described later in this manual. When you move down into the sub-menu, you can scroll round using the arrow keys, press ENTER to go to the required section of parameters.

Once you have reached the relevant section, scroll through the parameters, and enter the necessary information. To enter the information, use the numeric keys and then press ENTER, you will then see the message "**Saved!**" If you press CANCEL, then the change you made will not be saved, and the message "**Unchanged!!**" will be displayed.

When you have finished, press CANCEL to go back to the previous level. When you have reached the top level, then the Ultra 5 will ask for confirmation before allowing you to go back into run mode. This is done by pressing ENTER at the display prompt.

### Important Information

You can tell which part of the menu system you are in, as the up/down level indicators, (arrows) next to the bar graph will indicate as follows:

- **Top level menu:** **Down arrow on**, to indicate you can move down.
- **Sub-menu:** **Up and Down arrows on**, to indicate you can move up to the top level, and down to parameter level.
- **Parameter Level:** **Up arrow on**, to indicate you can move up to sub-menu level.
- **Parameter Editing:** **No arrows on**.

### Directly Editing Parameters

If you already know the number of the parameter, that you wish to look at or edit, simply type the number in at any time while you are in the menu system. Thus, if you are in either the menu or sub-menu level by pressing a numeric key, you can enter the parameter number directly and jump straight there. You cannot type a parameter number whilst at parameter level, only at one of the two menu levels.

When you are at a parameter, the text line rotates automatically displaying the parameter name, number, the applicable units, and the maximum and minimum figure you can enter. The top line shows the value you are setting.

Once you have accessed a parameter, you can either just look at it, or change it.

Once a parameter has been changed, press 'ENTER' and you will see the message "**Saved!**". If you press 'CANCEL', then the change you made will not be saved, and the message "**Unchanged!!**" will be displayed.



**You can jump straight to the last parameter you edited, by pressing '+/-' when you first enter program mode.**



## Test Mode

Test mode is used to simulate the application and confirm that all parameters and relay setpoints have been entered as expected. During simulation, there is a choice of whether the relays will change state (hard simulation) or not (soft simulation), but the LED's will always change colour as programmed, and the mA output will change in accordance to the chosen mode of operation. If you wish to test the logic of the system that the **relays are connected** to then select **hard simulation**, but if you **do not wish to change the relay state**, then select a **soft simulation**.

There are two simulation modes, automatic and manual. Automatic simulation will move the level up and down between empty level or the pre-determined **Start Level (P983)** and Pump/Control relay switch points, if you wish to change the direction of the level movement e.g. to go beyond relay setpoints, this can be done by using the arrow keys. In manual simulation, using the arrow keys will allow you to move the level up and down as required.

To enter simulation, first go to program mode. Using the menu system, select menu item '**Test**', then sub-menu item '**Simulation**'. Simply change the value of the parameter **P980** to one of the following:

- 1= Manual soft simulation
- 2= Automatic soft simulation
- 3= Manual hard simulation
- 4= Automatic hard simulation

To return to program mode, press 'CANCEL' and test mode will end.

When in manual simulation, by default test mode will move the level by 0.1m steps. Altering the **increment (P981)** will change this value.

In **automatic** mode, the rate at which the level moves up and down is set by the increment (P981 in metres, and the **rate (P982)** in minutes, which can be changed to make the level move up and down faster. E.g. if **increment (P981)** is set for 0.1m and **rate (P982)** is set to 1 min then the level will increase or decrease at a rate of 0.1m/min. To make the simulated level move slower, decrease the value in **increment (P981)** or increase the value in **rate (P982)**. To make the simulated level move faster, increase the value in **increment (P981)** or decrease the value in **rate (P982)**.

### *Using the Serial Interface*

The RS232 serial interface is used to communicate between the Ultra 5 and a PC using the optional Ultra PC and other associated Pulsar software packages, to obtain information such as data logging and view echo traces upload, download and save parameter files. In addition, it can also be used to control or obtain information using a standard PC or other computer base equipment. To do so, the settings for control are as follows: **baud rate 19,200, 8 data bits, no parity, 1 stop bit.**

The device should be connected as shown in [Chapter 2 Ultra 5 Installation](#).

To use the device remotely, you need to **log on** to start, and **log off** when finished. When **logged on**, Ultra 5 will show '**Remote ON**' on the display, and "**Communicator OFF**" when **logged off**.

*All commands should be followed by a carriage return.* When logged on, the unit will respond either OK (or a value) if the command is accepted, or NO if it is not.

To log on, send the command

/ACCESS:pppp where pppp is the passcode (P922).

To log off, send the command

/ACCESS:OFF

To read a parameter value, send the command

/Pxxx where xxx is the parameter you wish to read, and the Ultra 5 will respond with the parameter value.

To set a parameter, send the command

/Pxxx:yy where xxx is the parameter number, and yy is the value you wish to set it to.

Other commands you can use are:

/DISTANCE (shows current distance)

/LEVEL (shows current level)

/SPACE (shows current space)

/RATE (shows current rate)

/VOLUME (shows current volume)

/TEMP (shows current temperature)

/CURRENTOUT1 (show the mA output 1 value)

/CURRENTOUT2 (show the mA output 2 value)

/BACKUP1 (take backup of parameters to area 1)

/BACKUP2 (take backup of parameters to area 2)

/RESTORE1 (restore parameters from area 1)

/RESTORE2 (restore parameters from area 2)

Please consult Pulsar Measurement or contact your local Pulsar representative for further details and a full list of available commands.

## Parameter Defaults

### Factory Defaults

When first installing the Ultra 5, or subsequently moving or using the unit on a new application, before proceeding to program the unit for its intended application it is recommended that you ensure that all parameters are at their default values by completing a **Factory Default P930**, as described in the relevant unit type **parameter guide**.

When you first switch the Ultra 5 on, it will be reading the **distance** from the face of the transducer to the surface. It will be indicating in **metres**, as shown on the display. All relays are set OFF.

The **date (P931)** and **time (P932)** in the Ultra 5 were set at the factory, but may need checking, and amending if, for example the application is in a time zone other than GMT, see relevant parameter listing for full details.



In some applications, it is easier to empty the vessel, take a reading from the Ultra 5 for distance and then setup the empty level to this figure.

Once you are satisfied with the installation, and Ultra 5 is reading what you would expect in terms of distance from the face of the transducer to the material level, then you can proceed with programming, for the intended application. It is sensible to program all of the required parameters at the same time. The system will be then set-up.

**Note:** *The span is automatically calculated from the empty level, so the empty level should be entered first.*

## CHAPTER 4 ULTRA WIZARD

The Ultra Wizard menu allows you to turn Ultra 5 into **anyone** of **three** dedicated ultrasonic devices to exactly suit the requirements of your application.

### Enter Program Mode

First you need to go from run mode into program mode. Assuming the passcode is the default 1997, then you should enter the following on the keypad:



### Choose Ultra Wizard

Now you need to go into the quick setup. You will see on the menu the words 'Quick Setup', which is the first item on the menu system. Try pressing the two arrow keys to see some more menu options, but return to Quick Setup, and press

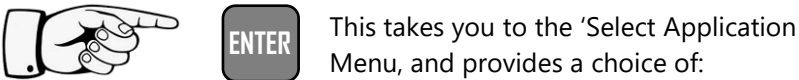

**1 = Level or Volume measurement (Level/Vol)**

**2 = Pump Control (Pump)**

**3 = Open Channel Flow measurement (Flow)**

APPLICATION	UNIT TYPE
1 = Level/Vol	When selected the Ultra 5 is configured as a <b>Level Star 5</b>
2 = Pump	When selected the Ultra 5 is configured as an <b>Advanced 5</b>
3 = Flow	When selected the Ultra 5 is configured as a <b>Flow 5</b>

### *Level/Volume*

If you require to set up a **level** or **volume** application, **with** or **without** a choice of **control functions** then press "1" followed by "ENTER" the message "Loading \*\*\*" will be displayed and your Ultra 5 will be configured as a **Level Star 5**. Confirmation that configuration has been completed will be given by the unit type, software version and serial number being displayed briefly on the LCD and the unit advancing to the relevant "Quick Setup" menu.

For full details on how to programme the **Level Star 5**, using the Quick Setup Menu, please proceed to **Chapter 5 Level/Volume**. For a full description of all features and parameters please refer to **Chapter 8 Parameter Listing and Description**.

### *Level Star 5*

The Level Star provides the ability to convert level measurement to enable the contents of a vessel to be displayed in volume, along with control functions, for a complete range of vessel shapes. Also available within the unit is a customised 32-point calibration routine which also permits the calculation of volume in non - standard vessels.

The Level Star can measure from zero to 40 m from the face of the transducer to the surface being monitored, dependent on the transducer used. The Level Star can show details of **level, space, distance** and units of **volume** on the display. The three user-definable relays with individual setpoints can be programmed to activate devices such as pumps or other control equipment. The 4-20 mA output is fully programmable to provide an output relative to **level, space, distance** or **volume** of the application being measured.

### *Pump*

If you require to set up a **pump** application, then press "2" followed by "ENTER" the message "Loading \*\*\*" will be displayed and your Ultra 5 will be configured as an **Advanced 5**. Confirmation that configuration has been completed will be given by the unit type, software version and serial number being displayed briefly on the LCD and the unit advancing to the relevant "Quick Setup" menu. For full details on how to programme the **Advanced 5**, using the Quick Setup Menu, please proceed to **Chapter 6 Pump**. For a full description of all features and parameters please refer to **Chapter 8 Parameter Listing and Description**.

### *Advanced 5*

The Advanced 5 level controller provides pump control with a complete range of pump “duties” being available.

The Advanced 5 can measure from zero to 15m from the face of the transducer to the surface being monitored, dependent on the transducer used. The Advanced 5 can show **level, space, or distance** on the display.

The three user definable relays with individual setpoints can be programmed to activate alarms, pump starters, or other control equipment.

The 4-20 mA output is fully programmable to provide an output relative to **level, space, or distance**.

### *Flow*

If you require to set up a **flow** application, then press “3” followed by “ENTER” the message “Loading \*\*\*\*” will be displayed and your Ultra 5 will be configured as a **Flow 5**. Confirmation that configuration has been completed will be given by the unit type, software version and serial number being displayed briefly on the LCD and the unit advancing to the relevant “Quick Setup” menu. For full details on how to programme the **Flow 5**, using the Quick Setup Menu, please proceed to **Chapter 7 Flow**. For a full description of all features and parameters please refer to **Chapter 8 Parameter Listing and Description**.

### *Flow 5*

The Flow 5 open channel flowmeter provides comprehensive flow monitoring with data logging and control functions for a complete range of flumes, weirs, and channels. Flow calculations to the British Standard BS3680 are available within the software together with calculations for a wide variety of other primary elements. Also available within the unit is a customised 32-point calibration routine which also permits the flow measurement of non - standard flumes and weirs.

The Flow 5 can measure from zero to 16 m from the transducer to the surface being monitored, dependent on the transducer used. The Flow 5 can show details of **level, space, distance, head, or flow** on the display along with a **totaliser** if desired. The three user-definable relays with individual setpoints can be programmed to activate devices such as pumps, samplers, remote totalisers, or other control equipment.

The 4-20 mA output is fully programmable to provide an output relative to **level, space, distance, head, or flow**.

## CHAPTER 5 LEVEL / VOLUME

### When Ultra Wizard = 1 Level/Volume

#### Ultra 5 is configured as a Level Star 5

This quick set-up guide shows you how to get up and running within a few minutes of installing your **Level Star 5**.

Before proceeding ensure that the **Ultra Wizard = 1 Level/Volume** (Level Star 3). For further details, see [Chapter 4 Ultra Wizard](#).

#### Enter Program Mode

First you need to go from run mode into program mode. Assuming the passcode is the default 1997, then you should enter this.



#### Choose Quick Setup

Now you need to go into the quick setup. You will see on the display the words 'Ultra Wizard', press the 'right hand' arrow key and this will take you to the 'Quick Setup' menu option. Try pressing either of the two arrow keys to see some more menu options, but return to Quick Setup, and press



This takes you to the 'Quick Setup Menu'



This takes you to the common applications menu, and several options will appear on the display.



### Factory Defaults

If you have already setup a common application, then there will be a number shown other than 0, and you will see messages showing what the current setup is. If you want to reset this and start again, press 0 (which will reset all the quick setup parameters), otherwise pressing ENTER will allow you to edit the parameters that have been set.

### *Choose Your Application*

There are two categories of application, which are all described later in this chapter. They are **level** or **volume** all with the choice of control functions and alarms.

If you want to set-up a basic **level monitoring** application, as described in the following **example 1**, then choose 1.

If you want to set-up a **level monitoring** application with **control relays**, as described in the following **example 2**, then choose 1 and choose either **control down** (press 1) or **control up** (press 2).

If you want to set-up a **volume** application, as described in the following **example 3**, then choose 2.

Once you have chosen your application you will be asked a series of questions which are answered by choosing the appropriate option as detailed in the flow chart below. Once all the questions have been answered you will be prompted to provide further information, as detailed in the tables below, to complete the programming of the unit.

**Quick Setup**

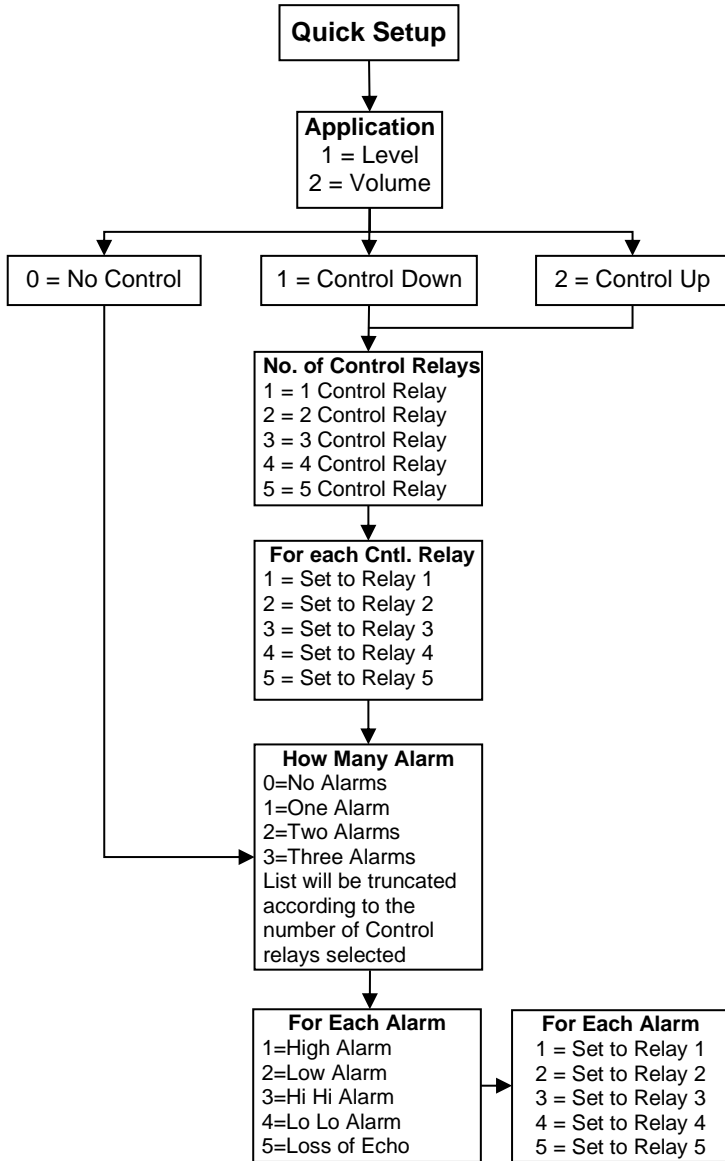

**Wait....**

<b>PARAMETER</b>	<b>DEFAULT</b>	<b>DESCRIPTION</b>
P101 Transducer	2 = dB6	Type of transducer being used.
P102 Material	1 = Liquid	Material in the vessel, either liquid or solid. If the solid lays flat, then it can be programmed as liquid.
P104 Measurement Units	1 = metres	Select units to be used for programming measurement information.
P105 Empty Level	6m	Distance from the face of the transducer to the material at the bottom of the vessel.
P106 Span	5.7m	Distance from the empty level (0% full) to span (100% full).

**If you have selected a Volume Application, you will now be prompted to enter details required for the calculation of volume**

<b>PARAMETER</b>	<b>DEFAULT</b>	<b>DESCRIPTION</b>
P600 Vessel Shape	0 = Cylinder Flat Base	Shape of vessel being monitored
P601–P603 Vessel Dimensions	Dependent on vessel shape selected	Enter vessel dimensions as required.
P605 Volume units	3 = Cubic metres	Selects volume units required
P607 Max Volume	Read Only	Displays the calculated Volume in P605 units.

**For More Options Hit Enter**

PARAMETER	DEFAULT	DESCRIPTION
P213 / P214 Relay 1 ON/OFF setpoints	Factory preset as a % to appropriate level according to the span already entered. See tables below	Either Alarm or Level control. Depends on application.
P223 / P224 Relay 2 ON/OFF setpoints	Factory preset as a % to appropriate level according to the span already entered. See tables below	Either Alarm or Level control. Depends on application.
P233 / P234 Relay 3 ON/OFF setpoints	Factory preset as a % to appropriate level according to the span already entered. See tables below	Either Alarm or Level control. Depends on application.
P243 / P244 Relay 4 ON/OFF setpoints	Factory preset as a % to appropriate level according to the span already entered. See tables below	Either Alarm or Level control. Depends on application.
P253 / P254 Relay 5 ON/OFF setpoints	Factory preset as a % to appropriate level according to the span already entered. See tables below	Either Alarm or Level control. Depends on application.
P830 mA Out Range	2 = 4 to 20mA	Determines the mA output range. 0 = Off, 1 = 0 to 20mA, <b>2 = 4 to 20mA</b> , 3 = 20 to 0mA, 4 = 20 to 4mA.
P870 Fill Damping	10m/min	Rate of maximum fill rate (set above the actual fill rate of the vessel).
P871 Empty Damping	10m/min	Rate of maximum empty rate (set above the actual rate of the vessel).

Alarm relays, via the Quick Setup menu are entered as a % of span and are as follows:

APPLICATION	NO. OF CTL RELAYS	CTL RELAY NUMBER	ON SETPOINT	OFF SETPOINT
Control Down	One	Control 1	80%	20%
Control Down	Two	Control 1	80%	20%
		Control 2	70%	20%
Control Down	Three	Control 1	80%	20%
		Control 2	70%	20%
		Control 3	60%	20%
Control Down	Four	Control 1	80%	20%
		Control 2	70%	20%
		Control 3	60%	20%
		Control 4	50%	20%
Control Down	Five	Control 1	80%	20%
		Control 2	70%	20%
		Control 3	60%	20%
		Control 4	50%	20%
		Control 5	40%	20%

APPLICATION	NO. OF CTL RELAYS	CTL RELAY NUMBER	ON SETPOINT	OFF SETPOINT
Control Up	One	Control 1	20%	80%
Control Up	Two	Control 1	20%	80%
		Control 2	30%	80%
Control Up	Three	Control 1	20%	80%
		Control 2	30%	80%
		Control 3	40%	80%
Control Up	Four	Control 1	20%	80%
		Control 2	30%	80%
		Control 3	40%	80%
		Control 4	50%	80%
Control Up	Five	Control 1	20%	80%
		Control 2	30%	80%
		Control 3	40%	80%
		Control 4	50%	80%
		Control 5	60%	80%

<b>RELAY FUNCTION</b>	<b>RELAY ID</b>	<b>ON SETPOINT</b>	<b>OFF SETPOINT</b>
Alarm	HiHi	90%	85%
Alarm	High	85%	80%
Alarm	Low	10%	15%
Alarm	LoLo	5%	10%

### Example 1 Level Monitoring with Alarms

A vessel, containing liquid that has a variation in level that is to be monitored, with a high-level alarm set on Relay 1 and low-level alarm set on Relay 2.

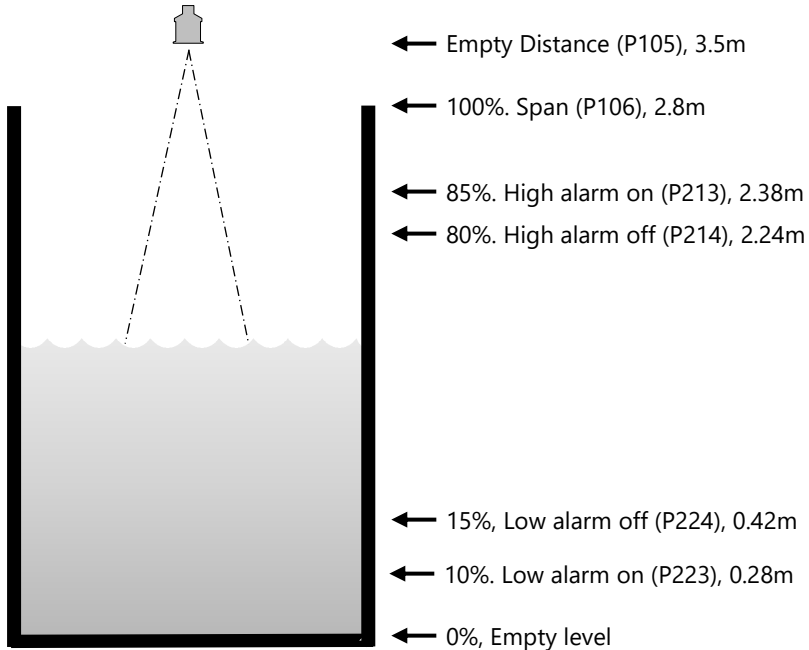

In this example, when the level rises to 2.38 m, relay 1 will come on until the level drops to 2.24 m when it will turn off. If the level drops to 0.28 m, then relay 2 will come on until it rises 0.42 m when it will turn off.

The display will show the level in the tank.

The mA output will be representative of level where 4mA = empty level (0%) and 20mA = 2.8m (100%).

To program the Ultra 5 for **Example 1 Level Monitoring with Alarms** by using the Quick Setup menu proceed as follows. If required to access **Program Mode**, key in the **passcode** 1997 and press **ENTER**

At the **Quick Setup** menu press **ENTER** and as prompted, by the questions, select the relevant option and **ENTER**.

QUESTION	OPTION
Level/Volume	1 = Level App.
No. of alarms	2 = 2 Alarms
Type alarm 1	1 = High
Alarm no.1	1 = Set to relay 1
Type alarm 2	2 = Low
Alarm no.2	2 = Set relay 2
Xducer (P101)	2 = dB6
Material (P102)	1 = Liquid
Measurement units (P104)	1 = Metres
Empty Level (P105)	3.5m
Span (P106)	2.8m

Programming is now complete, and the unit can be returned to the run mode, press **CANCEL** until **Run Mode?** Is displayed on the LCD press **ENTER**, and the Ultra 5 will return to the **Run Mode**.

**Important Notice**

If relay setpoints do not meet the exact requirements of the application, they can be modified to suit by pressing ENTER when, "For More Options Hit Enter", is displayed, and entering new values to relay setpoints as required. Alternatively, the relevant relay setpoint can be accessed either by the main menu system or directly via parameter number and changed as necessary.



### Example 2 Level Monitoring and Control (up or down)

A vessel, containing a liquid that has a variation in level that is to be monitored, and when the level reaches a specific point, the vessel is pumped down, with the fluid being transferred to another process. The pump will be assigned to Relay 1 a High Alarm to Relay 2 and Low Alarm to Relay 3.

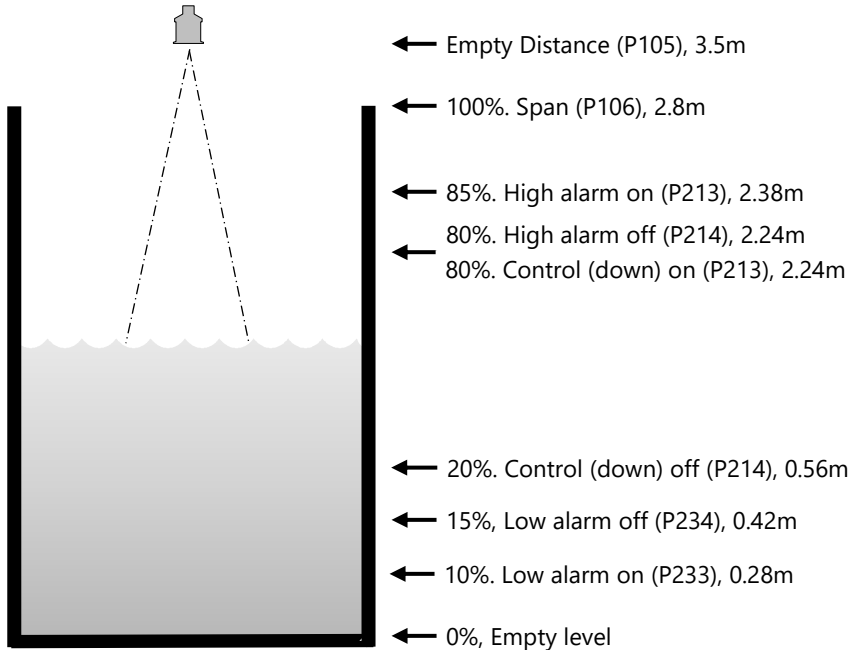

In this example, there is a **control** relay (relay 1), which will come on if the level rises to 2.24m, and go off when the level drops to 0.56m (**control down**). If the level rises to 2.4m, then the high-level alarm (relay 2) will come on until the level drops to 2.24m. If the level falls to 0.28m, then the low-level alarm (relay 3) will come on until the level rises to 0.42m.

Alternatively, if it is a **control up** application, then the on and off points for the control relay are reversed, so the control device comes on when the level is at 0.56m and goes off when it rises to 2.24m.

The display will show the level in the tank and the mA output will be representative of level where 4mA = empty level (0%) and 20mA = 2.8m (100%).

To program the unit for **Example 2 Level Monitoring and Control** by using the **Quick Setup** menu proceed as follows. If required access the **Program Mode**, key in the **passcode** 1997 and press **ENTER**.

Using the 'right' arrow key, go to the **Quick Setup** menu press **ENTER** and as prompted, by the questions, select the relevant option and press **ENTER**.

QUESTION	OPTION
Level/Volume	1 = Level App.
Control	1 = Control down
No. of controls	1 = 1 Relay
Control no.1	1 = Set to relay 1
No. of alarms	2 = 2 Alarms
Type alarm 1	1 = High
Alarm no.1	1 = Set to relay 2
Type alarm 2	2 = Low
Alarm no.2	The unit knows that only Relay 3 is available and so will automatically set Alarm 2 to Relay 3.
Xducer (P101)	2 = dB6
Material (P102)	1 = Liquid
Measurement units (P104)	1 = Metres
Empty Level (P105)	3.5m
Span (P106)	2.8m

Programming is now complete, and the unit can be returned to the run mode, press **CANCEL** until **Run Mode?** Is displayed on the LCD press **ENTER**, and the Ultra 5 will return to the **Run Mode**.

**Important Notice**

If relay setpoints do not meet the exact requirements of the application, they can be modified to suit by pressing ENTER when, "For More Options Hit Enter", is displayed and entering new values to relay setpoints as required. Alternatively, the relevant relay setpoint can be accessed either by the main menu system or directly via parameter number and changed, as necessary.

### Example 3 Volume Application

A cylindrical tank with a diameter of 2m and a flat base that is typically used to temporarily hold liquid, and you wish to know the volume of liquid. You also require a high and low alarm and when the level reaches a specific point, the vessel is pumped down, with the fluid being transferred to another process.

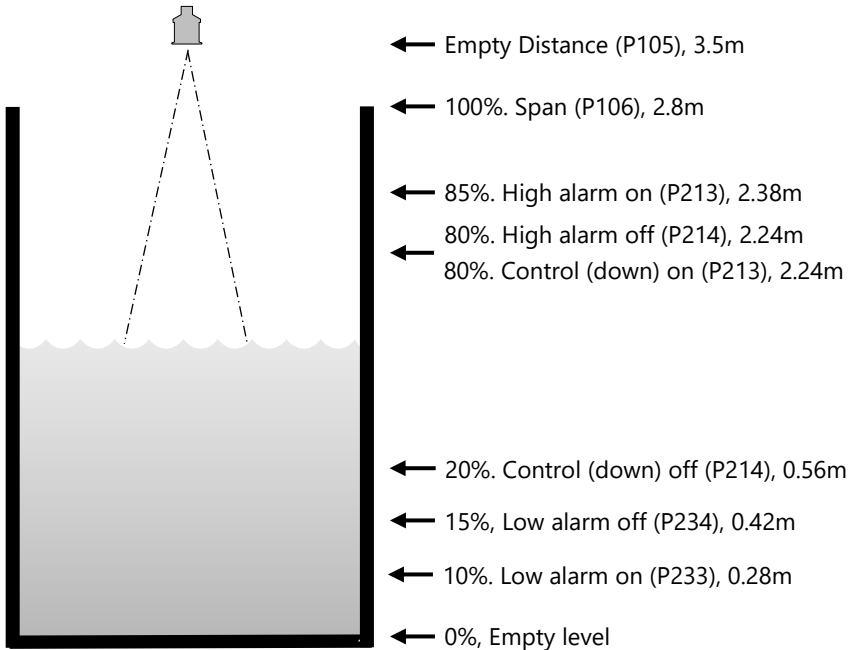

In this example, there is a pump (relay 1), which will come on if the level rises to 2.24m, and go off when the level drops to 0.56m. (**control down**). If the level rises to 2.38m, then the high-level alarm (relay 2) will come on until the level drops to 2.24 m. If the level falls to 0.28m, then the low-level alarm (relay 3) will come on until the level rises to 0.42m.

The display will show the volume of fluid in the tank and the mA output will be representative of Volume where 4mA = empty (0%) and 20mA = Max Volume (100%).

To program the Level Star for **Example 3 Volume Application with Control** by using the **Quick Setup** menu proceed as follows. If required access the **Program Mode and** key in the **passcode** 1997 and press **ENTER**.

Using the 'right' arrow key, go to the **Quick Setup** menu press **ENTER** and as prompted, by the questions, select the relevant option and **ENTER**.

QUESTION	OPTION
Level/Volume	1 = Level App.
Control	1 = Control down
No. of controls	1 = 1 Relay
Control no.1	1 = Set to relay 1
No. of alarms	2 = 2 Alarms
Type alarm 1	1 = High
Alarm no.1	1 = Set to relay 2
Type alarm 2	2 = Low
Alarm no.2	The unit knows that only Relay 3 is available and so will automatically set Alarm 2 to Relay 3.
Xducer (P101)	2 = dB6
Material (P102)	1 = Liquid
Measurement units (P104)	1 = Metres
Empty Level (P105)	3.5m
Span (P106)	2.8m
Vessel shape (P600)	0 = Cylindrical flat base
Vessel dimensions	Enter vessel dimensions as requested (depends on vessel shape chosen)
Volume units	Select as required
Max Volume (Read only)	Displays the Max volume as calculated by the Ultra 5

Programming is now complete, and the unit can be returned to the run mode, press **CANCEL** until **Run Mode?** Is displayed on the LCD press **ENTER**, and the Ultra 5 will return to the **Run Mode**.

**Important Notice**

If relay setpoints do not meet the exact requirements of the application, they can be modified to suit by pressing ENTER when, "For More Options Hit Enter", is displayed and entering new values to relay setpoints as required. Alternatively, the relevant relay setpoint can be accessed either by the main menu system or directly via parameter number and changed, as necessary.

## CHAPTER 6 PUMP

### When Ultra Wizard = 2 Pump Ultra 5 is configured as a Advanced 5

This quick set-up guide shows you how to get up and running within a few minutes of installing your **Advanced 5**.

Before proceeding ensure that the **Ultra Wizard = 2 Pump** (Advanced 5). For further details, see [Chapter 4 Ultra Wizard](#).

#### Enter Program Mode

First you need to go from run mode into program mode. Assuming the passcode is the default 1997, then you should enter this.



#### Choose Quick Setup

Now you need to go into the quick setup. You will see on the display the words 'Ultra Wizard', press the 'right hand' arrow key and this will take you to the 'Quick Setup' menu option. Try pressing either of the two arrow keys to see some more menu options, but return to Quick Setup, and press



This takes you to the 'Quick Setup Menu'



This takes you to the common applications menu, and several options will appear on the display.

**Important Notice**

If you have already setup a common application, then there will be a number shown other than 0, and you will see messages showing what the current setup is. If you want to reset this and start again, press 0 (which will reset all the quick setup parameters), otherwise pressing ENTER will allow you to edit the parameters that have been set.

*Choose Your Application*

There are three categories of application, which are all described later in this chapter. They are **level**, **pump down** (sump control) or **pump up** (reservoir control) all with the choice of alarms.

If you want to set-up a basic **level monitoring** application, as described in the following **example 1**, then choose 1.

If you want to set-up a **pump down** (sump control) application, as described in the following **example 2** then choose 2.

If you want to set-up a **pump up** (reservoir control) application, as described in the following **example 3** then choose 3.

Once you have chosen your application you will be asked a series of questions which are answered by choosing the appropriate option as detailed in the flow chart below. Once all the questions have been answered you will be prompted to provide further information, as detailed in the tables below, to complete the programming of the unit.

The Quick Setup Menu detailing the questions you will be asked when setting up your Ultra 5 unit, via the Quick Setup is shown below:

**Quick Setup Menu**

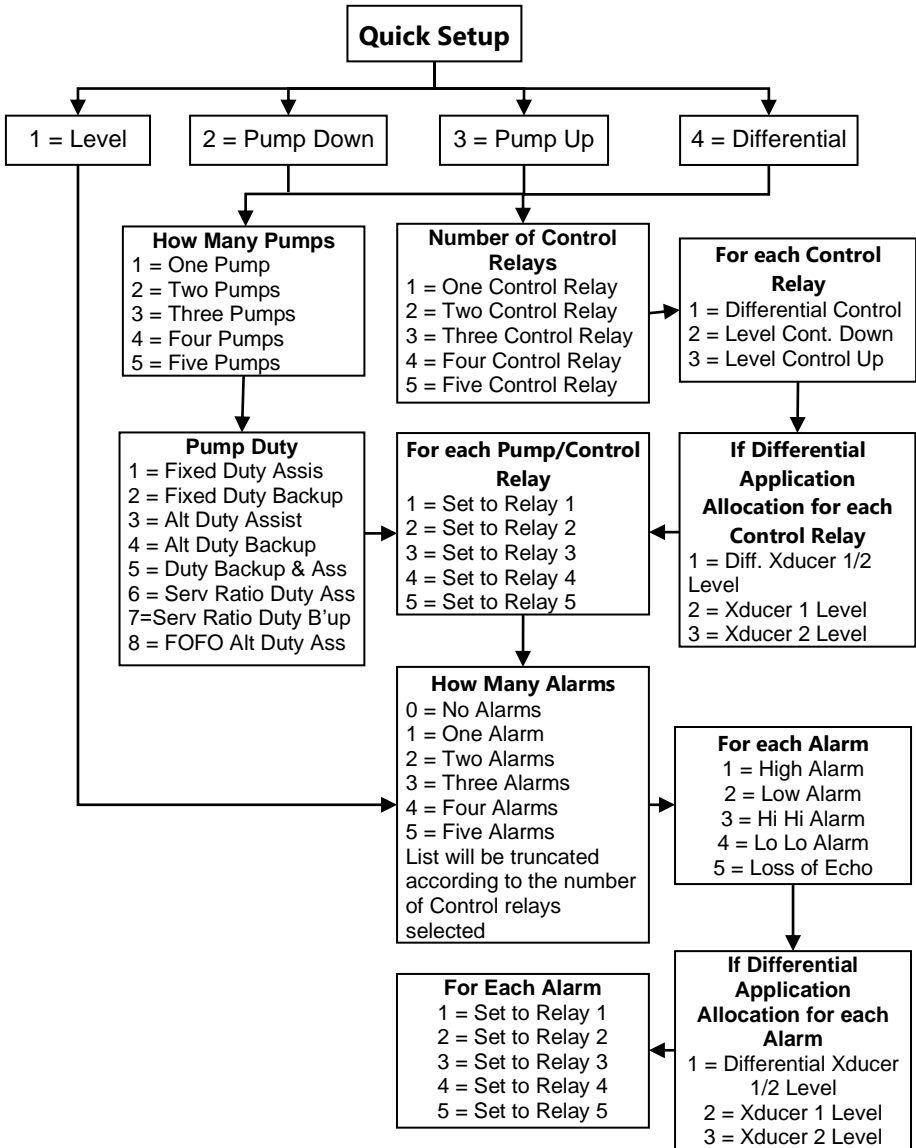



**Wait....**

<b>PARAMETER</b>	<b>DEFAULT</b>	<b>DESCRIPTION</b>
P101 Transducer	2 = dB6	Type of transducer being used
P104 Measurement units	1 = Metres	Select units to be used for programming measurement information
P105 Empty Level	6m	Distance from the face of the transducer to the material at the bottom of the vessel
P106 Span	5.7m	Distance from the empty level (0% full) to span (100% full).

**For More Options Hit Enter**

<b>PARAMETER</b>	<b>DEFAULT</b>	<b>DESCRIPTION</b>
P213 / P214 Relay 1 ON/OFF setpoints	Factory preset as a % to appropriate level according to the span already entered. See tables below	Either Alarm or Level control. Depends on application.
P223 / P224 Relay 2 ON/OFF setpoints	Factory preset as a % to appropriate level according to the span already entered. See tables below	Either Alarm or Level control. Depends on application.
P233 / P234 Relay 3 ON/OFF setpoints	Factory preset as a % to appropriate level according to the span already entered. See tables below	Either Alarm or Level control. Depends on application.
P243 / P244 Relay 4 ON/OFF setpoints	Factory preset as a % to appropriate level according to the span already entered. See tables below	Either Alarm or Level control. Depends on application.
P253 / P254 Relay 5 ON/OFF setpoints	Factory preset as a % to appropriate level according to the span already entered. See tables below	Either Alarm or Level control. Depends on application.

PARAMETER	DEFAULT	DESCRIPTION
P830 mA Out Range	2 = 4 to 20mA	Determines the mA output range. 0 = Off, 1 = 0 to 20mA, <b>2 = 4 to 20mA</b> , 3 = 20 to 0mA, 4 = 20 to 4mA.
P870 Fill damping	10m/min	Rate of maximum fill rate (set above the actual fill rate of the vessel).
P871 Empty damping	10m/min	Rate of maximum empty rate (set above the actual empty rate of the vessel).

The default values used for determining the **relay setpoints**, when setting **Alarms** and **Pump** relays, via the **Quick Setup** menu are entered as a % of span and are as follows.

APPLICATION	NO. OF PUMPS	PUMP NUMBER	ON SETPOINT	OFF SETPOINT
Pump Down	One	Pump 1	50%	20%
Pump Down	Two	Pump 1	50%	20%
		Pump 2	70%	20%
Pump Down	Three	Pump 1	50%	20%
		Pump 2	60%	20%
		Pump 3	70%	20%
Pump Down	Four	Pump 1	50%	20%
		Pump 2	60%	20%
		Pump 3	70%	20%
		Pump 4	80%	20%
Pump Down	Five	Pump 1	50%	20%
		Pump 2	60%	20%
		Pump 3	70%	20%
		Pump 4	80%	20%
		Pump 5	90%	20%

APPLICATION	NO. OF PUMPS	PUMP NUMBER	ON SETPOINT	OFF SETPOINT
Pump Up	One	Pump 1	50%	80%
Pump Up	Two	Pump 1	50%	80%
		Pump 2	30%	80%
Pump Up	Three	Pump 1	50%	80%
		Pump 2	40%	80%
		Pump 3	30%	80%
Pump Up	Four	Pump 1	60%	80%
		Pump 2	50%	80%
		Pump 3	40%	80%
		Pump 4	30%	80%
Pump Up	Five	Pump 1	60%	80%
		Pump 2	50%	80%
		Pump 3	40%	80%
		Pump 4	30%	80%
		Pump 5	25%	80%

APPLICATION	NO. OF CTL RELAYS	CTL RELAY NUMBER	ON SETPOINT	OFF SETPOINT
Level Cntl Down	One	Control 1	50%	80%
Level Cntl Down	Two	Control 1	50%	80%
		Control 2	30%	80%
Level Cntl Down	Three	Control 1	50%	80%
		Control 2	40%	80%
		Control 3	30%	80%
Level Cntl Down	Four	Control 1	60%	80%
		Control 2	50%	80%
		Control 3	40%	80%
		Control 4	30%	80%
Level Cntl Down	Five	Control 1	60%	80%
		Control 2	50%	80%
		Control 3	40%	80%
		Control 4	30%	80%
		Control 5	25%	80%

APPLICATION	NO. OF CTL RELAYS	CTL RELAY NUMBER	ON SETPOINT	OFF SETPOINT
Level Cntl Up	One	Control 1	20%	80%
Level Cntl Up	Two	Control 1	20%	80%
		Control 2	30%	80%
Level Cntl Up	Three	Control 1	20%	80%
		Control 2	30%	80%
		Control 3	40%	80%
Level Cntl Up	Four	Control 1	20%	80%
		Control 2	30%	80%
		Control 3	40%	80%
		Control 4	50%	80%
Level Cntl Up	Five	Control 1	20%	80%
		Control 2	30%	80%
		Control 3	40%	80%
		Control 4	50%	80%
		Control 5	60%	80%

APPLICATION	NO. OF CTL RELAYS	CTL RELAY NUMBER	ON SETPOINT	OFF SETPOINT
Differential Control	One	Control 1	5%	1%
Differential Control	Two	Control 1	5%	1%
		Control 2	10%	1%
Differential Control	Three	Control 1	5%	1%
		Control 2	10%	1%
		Control 3	15%	1%
Differential Control	Four	Control 1	5%	1%
		Control 2	10%	1%
		Control 3	15%	1%
		Control 4	20%	1%
Differential Control	Five	Control 1	5%	1%
		Control 2	10%	1%
		Control 3	15%	1%
		Control 4	20%	1%
		Control 5	25%	1%

<b>RELAY FUNCTION</b>	<b>RELAY ID</b>	<b>ON SETPOINT</b>	<b>OFF SETPOINT</b>
Alarm	HiHi	90%	85%
Alarm	High	85%	80%
Alarm	Low	10%	15%
Alarm	LoLo	5%	10%

**Example 1 Level Monitoring with Alarms**

A vessel, containing liquid that has a variation in level that is to be monitored, with a high-level alarm set on Relay 1 and low-level alarm set on Relay 2.

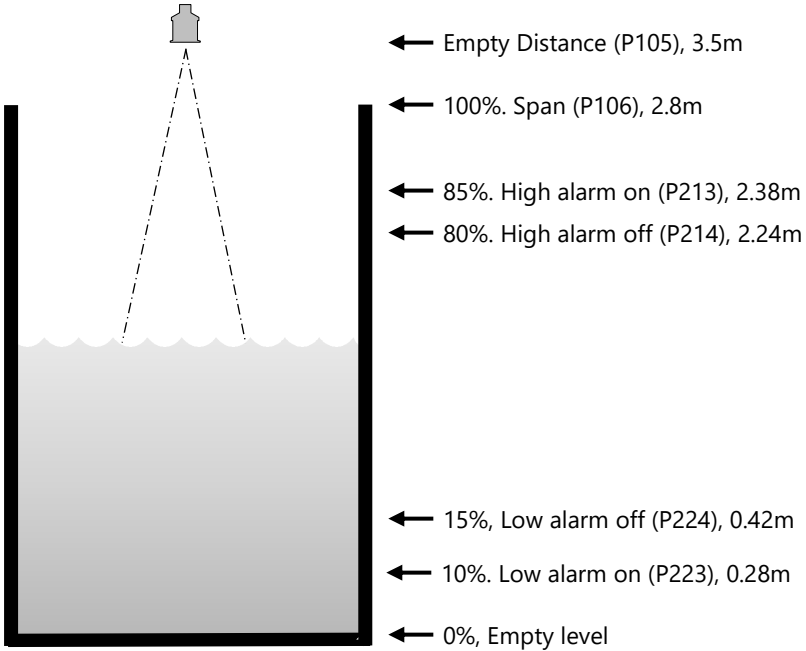

In this example, when the level rises to 2.38 m, relay 1 will come on until the level drops to 2.24 m when it will turn off. If the level drops to 0.28 m, then relay 2 will come on until it rises 0.42 m when it will turn off.

The display will show the level in the tank.

The mA output will be representative of level where 4mA = empty level (0%) and 20mA = 2.8m (100%).

To program the Ultra 5 for **Example 1 Level Monitoring with Alarms** by using the Quick Setup menu proceed as follows. If required to access **Program Mode**, key in the **passcode** 1997 and press **ENTER**

At the **Quick Setup** menu press **ENTER** and as prompted, by the questions, select the relevant option and **ENTER**.

QUESTION	OPTION
Level/Pump up/down or differential	1 = Level App.
No. of alarms	2 = 2 Alarms
Type alarm 1	1 = High
Alarm no.1	1 = Set to relay 1
Type alarm 2	2 = Low
Alarm no.2	2 = Set relay 2
Xducer (P101)	2 = dB6
Material (P102)	1 = Liquid
Measurement units (P104)	1 = Metres
Empty Level (P105)	3.5m
Span (P106)	2.8m

Programming is now complete, and the unit can be returned to the run mode, press **CANCEL** until **Run Mode?** Is displayed on the LCD press **ENTER**, and the Ultra 5 will return to the **Run Mode**.

### Important Notice

If relay setpoints do not meet the exact requirements of the application, they can be modified to suit by pressing ENTER when, "For More Options Hit Enter", is displayed, and entering new values to relay setpoints as required. Alternatively, the relevant relay setpoint can be accessed either by the main menu system or directly via parameter number and changed as necessary.

**Example 2 Sump Control (pump down)**

A sump is typically used to temporarily hold water or effluent, and when the level reaches a specific point, the sump is pumped down, with the fluid being transferred to another process.

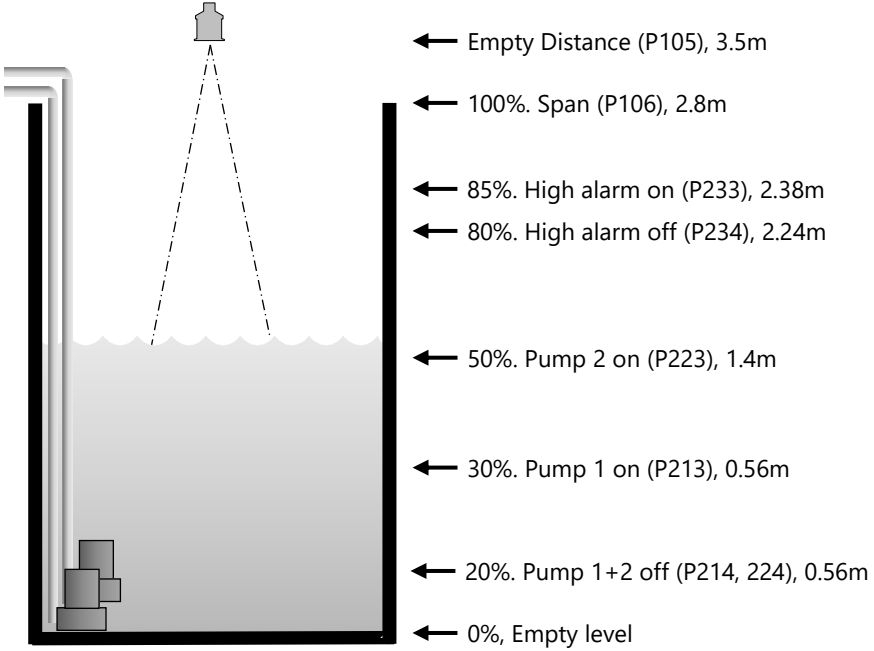

In this example, there are two pumps, which will be set to **alternate duty assist**, so they come on alternately. Pump 1 is to be set to relay 1, pump 2 to relay 2, and the high-level alarm to relay 3.

This will operate as follows. During normal operation, **pump 1** will come on at 0.84m and pump down to 0.56m. The setpoints are then shifted to **pump 2**, which will come on first next time. During peak periods, when **pump 1** cannot cope, **pump 1** will come on at 0.84m, **pump 2** will come on at 1.4m, and pump down to 0.56m. The setpoints are then shifted to **pump 2**, which will come on **first next time**.



If neither pump can cope, and the level rises to 2.38m, then the alarm relay (relay 3) will come on and go off when the level falls to 2.24m. This will indicate insufficient capacity of the pumps. The display will show the level in the sump and the mA output will be representative of level where 4mA = empty level (0%) and 20mA = 2.8m (100%).

To program the Ultra 5 for **Example 2 Sump control (pump down)** by using the **Quick Setup** menu proceed as follows. If required to access **Program Mode**, key in the **passcode** 1997 and press **ENTER**

At the **Quick Setup** menu press **ENTER** and as prompted, by the questions, select the relevant option and **ENTER**.

QUESTION	OPTION
Level/Pump Up/Down/Differential	2 = Pump Down
No. of Pumps	2 = 2 Pumps
Pump Duty	3 =Alt Duty Assist
Pump No. 1	1 = Set to relay 1
Pump No. 2	2 = Set to relay 2
Type Alarm 1	1 = High Alarm
Alarm No. 1	5 = Set to relay 5
Xducer (P101)	2 = dB6
Measurement units (P104)	1 = Metres
Empty Level (P105)	3.5m
Span (P106)	2.8m

Programming is now complete, and the unit can be returned to the run mode, press **CANCEL** until **Run Mode?** Is displayed on the LCD press **ENTER**, and the Ultra 5 will return to the **Run Mode**.

### Important Notice

If relay setpoints do not meet the exact requirements of the application, they can be modified to suit by pressing ENTER when, "For More Options Hit Enter", is displayed, and entering new values to relay setpoints as required. Alternatively, the relevant relay setpoint can be accessed either by the main menu system or directly via parameter number and changed as necessary.

**Example 3 Reservoir Control (pump Up)**

A sump is typically used to temporarily hold water or effluent, and when the level reaches a specific point, the sump is pumped down, with the fluid being transferred to another process.

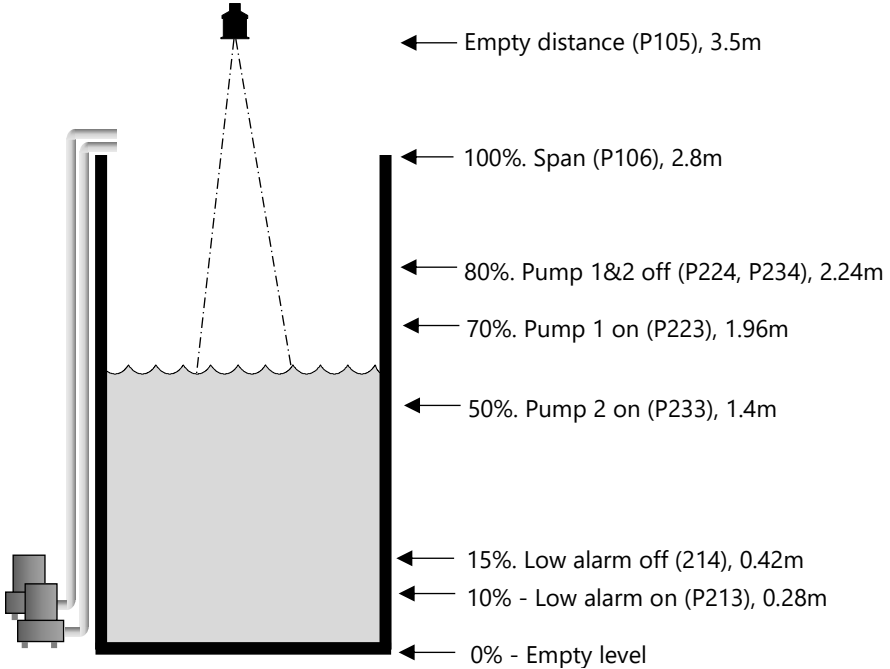

In this example, there are two pumps, which will be set to alternate duty assist, so they come on alternately. Pump 1 is to be set to relay 2, pump 2 to relay 3, and the low-level alarm to relay 1. This will operate as follows:

During normal operation, **pump 1** will come on at 1.96m and pump up to 2.24m. The setpoints are then shifted to **pump 2**, which will come on **first next time**. During peak periods, when **pump 1** cannot cope, **pump 1** will come on at 1.96m and **pump 2** will come on at 1.4m and pump up to 2.24m. The setpoints are then shifted to **pump 2**, which will come on **first next time**. If both pumps cannot cope, and the level falls to 0.28m, then the alarm relay (relay 3) will come on and go off when the level rises to 0.42m. This will indicate insufficient capacity of the pumps.

The display will show the level in the sump and the mA output will be representative of level where 4mA = empty level (0%) and 20mA = 2.8m (100%).

To program the Ultra 5 for **Example 3 Reservoir Control (pump up)** by using the **Quick Setup** menu proceed as follows. If required access the **Program Mode** and key in the **passcode** 1997 and press **ENTER**

Using the 'right arrow key, go to **Quick Setup** menu press **ENTER** and as prompted, by the questions, select the relevant option and **ENTER**.

QUESTION	OPTION
Level/Pump Up/Down/Differential	2 = Pump Down
No. of Pumps	2 = 2 Pumps
Pump Duty	3 =Alt Duty Assist
Pump No. 1	1 = Set to relay 2
Pump No. 2	2 = Set to relay 3
No. of alarms	1 = 1 alarm
Type Alarm 1	1 = High Alarm
Alarm No. 1	The unit knows that only relay 1 is available and so will automatically set alarm 1 to Relay 1
Xducer (P101)	2 = dB6
Measurement units (P104)	1 = Metres
Empty Level (P105)	3.5m
Span (P106)	2.8m

Programming is now complete, and the unit can be returned to the run mode, press **CANCEL** until **Run Mode?** Is displayed on the LCD press **ENTER**, and the Advanced 5 will return to the **Run Mode**.

### Important Notice

If relay setpoints do not meet the exact requirements of the application, they can be modified to suit by pressing ENTER when, "For More Options Hit Enter", is displayed, and entering new values to relay setpoints as required. Alternatively, the relevant relay setpoint can be accessed either by the main menu system or directly via parameter number and changed as necessary.

**Example 4 Differential Control**

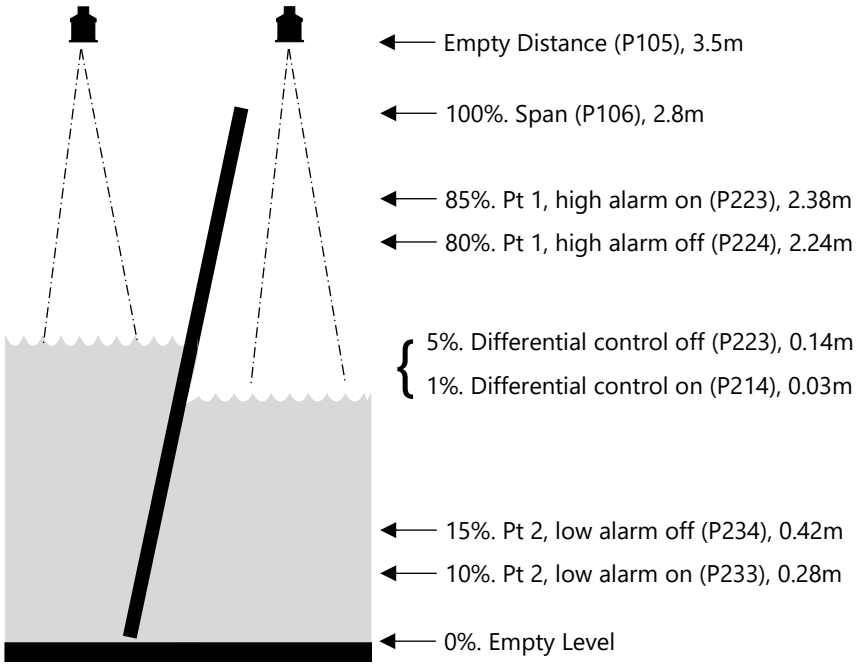

**Important Notice**

When using the Advanced 5 to measure differential, the transducers should be installed at the same height, to ensure that no differential is present when the level is zero on both sides. If this is not possible then a measurement offset (P851) or Display Offset (P802) must be applied to ensure the correct reading is obtained.

In this example the Advanced 5 is being used to control a rake on a screen, which is filtering out solids in the inlet flow to a wastewater treatment plant. A **high alarm** has been assigned to Pt 1 (**Transducer 1**), on the **upstream** side and a **low alarm**, to Pt 2 (**Transducer 2**) on the **downstream** side. The Diff. Control, to operate the rake is on relay 1, high alarm, on Transducer 1 (upstream), is on relay 2 and, low alarm, on Transducer 2 (downstream) is on relay 3.

This will operate as follows, when the level rises on the upstream side and/or the level on the downstream side falls, resulting in a differential of 0.14m, (anywhere within the working span), indicating that the screen is blocked, relay 1 will come on and operate the rake. Once the level on the inflow has decreased and the differential level falls to 0.03m relay 1 will switch off the rake.

Should the level on the upstream side rise, for any reason, to a level of 2.38m, relay 2 will operate to give a high alarm, once the level has fallen back to 2.24m the alarm will go off. A falling level in the downstream side, for any reason, will operate relay 3 at 0.28m giving an alarm for low level, once the level has risen again to a value of 0.42 m relay 3 will reset.

To program the Advanced 5 for **Example 2 Differential Control** by using the **Quick Setup** menu proceed as follows. Access the **Program Mode** and key in the **passcode** 1997 and press **ENTER**. At the **Quick Setup** menu press **ENTER** and as prompted, by the questions, select the relevant option and **ENTER**.

QUESTION	OPTION
Level/Pump Up/Down/Differential	4 = Differential
No. of Control relays	1 = 1 Control
Control	1 = Differential Control
No. of alarms	2 = 2 alarm
Type Alarm 1	1 = High Alarm
Alarm No. 1	Set to Relay 2
Allocate Alarm 1	2 = Xducer 1
Type Alarm 2	4 = Low alarm
Alarm No. 2	3 = Set to Relay 3
Allocate Alarm 2	3 = Xducer 2
Xducer (P101)	2 = dB6
Measurement units (P104)	1 = Metres
Empty Level (P105)	3.5m
Span (P106)	2.8m

Programming is now complete, and the unit can be returned to the run mode, press **CANCEL** until **Run Mode?** Is displayed on the LCD press **ENTER**, and the Advanced 5 will return to the **Run Mode**.

## CHAPTER 7 FLOW

### When Ultra Wizard = 3 Flow Ultra 5 is configured as a Flow 5

This quick set-up guide shows you how to get up and running within a few minutes of installing your **Flow 5**.

Before proceeding ensure that the **Ultra Wizard = 3 Flow** (Flow 5). For further details, see [Chapter 4 Ultra Wizard](#).

#### Enter Program Mode

First you need to go from run mode into program mode. Assuming the passcode is the default 1997, then you should enter this.



#### Choose Quick Setup

Now you need to go into the quick setup. You will see on the display the words 'Ultra Wizard', press the 'right hand' arrow key and this will take you to the 'Quick Setup' menu option. Try pressing either of the two arrow keys to see some more menu options, but return to Quick Setup, and press



This takes you to the 'Quick Setup Menu'



This takes you to the common applications menu, and several options will appear on the display.

### *Choose Your Application*

There are six categories of **Primary Measuring Device**, which are all described in this chapter. They are **exponential, BS3860 flumes, BS3860 weirs, area/velocity, special and universal**.

Calculations for flow can be performed using absolute or ratiometric calculations. The answer will be the same, the choice of calculation method being limited to the amount of information available, with regards to the primary measuring device.

For ratiometric calculation it is normally sufficient to know the maximum flow at maximum head for the device in question. All types of primary measuring devices can be set up with a choice of alarms.

If you want to set-up a basic **exponential device**, as described in the following **example 1**, then choose 1. You then need to select the **primary measuring device** for your application from the following available options: **suppressed rectangular weir, Cipolletti (trapezoidal) weir, Venturi flume, Parshall flume, Leopold Lagco flume, V notch weir** or **other**, for any other type of exponential device.

To set-up an application for a **BS3680 flume**, as described in the following **example 2**, then choose 2. You then need to select the **primary measuring device** for your application from the following available options: **rectangular flume with** or **without hump, U-throated flume with** or **without hump**.

To set-up an application for a **BS3680 weir**, as described in the following **example 3**, then choose 3. You then need to select the **primary measuring device** for your application from the following available options: **rectangular weir, V notch full 90° (90degrees), V notch half 90° (53 degree 8 minutes)** or a **V notch quarter 90° (28 degree 4 minutes)**.

To set-up an application for **area velocity**, then choose 4. You then need to select the **primary measuring device** for your application from the following available options: **U-channel** (circular bottom with straight sides), **rectangular channel, trapezoidal channel**, or a **round pipe**.

To set-up an application for a device contained in **special**, choose 5. You then need to select the **primary measuring device** for your application from the following available options: **Palmer Bowlus flume, H-flume** or a **V notch**, other than BS3680.

For devices which do not match any of the above devices the application can be setup using a **universal flow calculation**, to select this option choose 6. You then need to select the **primary measuring device** for your application from the following available options: **linear flow** or **curved flow**.

Once you have chosen your application you will be asked a series of questions which are answered by choosing the appropriate option as detailed in the flow chart below. Once all the questions have been answered you will be prompted to provide further information, as detailed in the tables below, in order to complete the programming of the unit.



*Quick Setup Menu*

The Quick Setup Menu detailing the questions you will be asked, when setting up your Flow 5, via the Quick Setup is shown below.

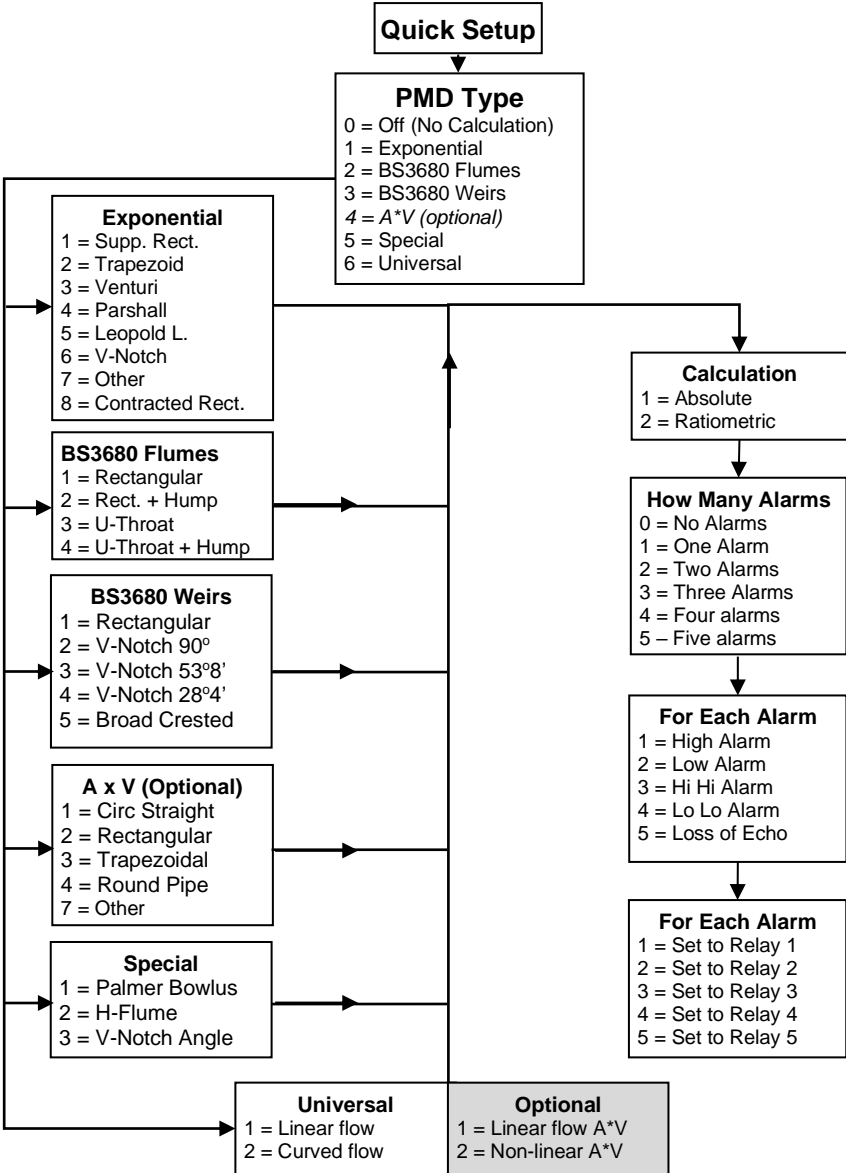

**Wait....**

PARAMETER	DEFAULT	DESCRIPTION
P101 Transducer	1 = dB Mach3	Type of transducer being used
P706 Volume units	1 = Litres	Units of flow as on display and used for calculations. 1 = Litres      2 = Cubic metres 3 = Cubic Feet   4 = UK gallons 5 = US gallons   6 = Mil. USG
P707 Time Units	1 = per second	Units of time that volume units will be displayed and calculated in
P104 Measurement units	1 = Metres	Used to enter dimensions and displayed where appropriate 1 = Metres      2 = Centimetres 3 = Millimetres   4 = Feet 5 = Inches
P105 Empty Level	2.425m	Distance from the end of the transducer horn (dB Mach3) or face of the transducer to the material at the bottom of the measuring element
P703 Minimum head	0.00m	Distance from empty point (P105) to zero flow.
P704 Max head	2.425m	Distance from zero flow to max flow. It should be noted that any change to P704 updates P106 Span and vice versa.
P824 Totaliser enable	1 = On	Enables the flow totaliser, P820, options are <b>0=Off, 1=On</b> . Note this totaliser can be viewed during run via the totaliser "Hot Key" It can be reset but only via P820, whilst in "program mode".
P816 Totaliser (R)	0 = No	Enables the totaliser to be displayed in the auxiliary display whilst in "run mode". Note the totaliser is "resettable" whilst in run mode via the totaliser hot key.

PARAMETER

DEFAULT

DESCRIPTION

P823 Totaliser multiplier	4 = *1	Sets the factor by which the calculated volume will be divided or multiplied by before being displayed. 1 = /1,000      2 = /100 3 = /10          4 = *1 5 = *10          6 = *100 7 = *1,000      8 = *10,000 9 = *100,000   10 = *1,000,000
------------------------------	--------	--

The remaining parameters required to finalise the setup of your application will follow on immediately from the above. These parameters relate to details required to carry out the calculation for flow and will be dependent on the Primary Measuring Device chosen and the method of calculation chosen, please enter values for the parameters concerned as requested.

PARAMETER	DEFAULT	DESCRIPTION
P705 Max flow	0.00	When requested enter the known maximum flow rate, in units of volume (P706) and Time (P707) which occurs at maximum head (P704)
P710 Dimension A	0	When requested, enter, in measurement units (P104) the required dimension.
P711 Dimension B	0	When requested, enter, in measurement units (P104) the required dimension.
P712 Dimension C	0	When requested, enter, in measurement units (P104) the required dimension.
P713 Dimension D	0	When requested, enter, in measurement units (P104) the required dimension.
P717 Exponent	Dependent on chosen PMD	Where available the unit will automatically enter the default exponent value for the PMD chosen, but this can be changed if required. When P700 = 7 (Other), enter the exponent value as defined by the manufacturer of the PMD.
P718 K Factor		Enter the 'K' factor for the PMD. Obtained from the manufacturer's specifications

**For More Options Hit Enter**



PARAMETER	DEFAULT	DESCRIPTION
P213 / P214 Relay 1 ON/OFF setpoints	Depends on application	Either Alarm or Level control. Depends on application.
P223 / P224 Relay 2 ON/OFF setpoints	Depends on application	Either Alarm or Level control. Depends on application.
P233 / P234 Relay 3 ON/OFF setpoints	Depends on application	Either Alarm or Level control. Depends on application.
P243 / P244 Relay 4 ON/OFF setpoints	Depends on application	Either Alarm or Level control. Depends on application.
P253 / P254 Relay 5 ON/OFF setpoints	Depends on application	Either Alarm or Level control. Depends on application.
P708 Flow Decimal	2	Sets the number of decimal points required in the flow rate display.
P709 Flow cut off	5%	Enter, as a percentage maximum flow. The minimum flow rate to be added to the totaliser.
P830 mA Out range	2 = 4 -20mA	What the mA output uses for the range. 0= Off, 1= 0 to 20 mA, 2= 4 to 20 mA, 3= 20 to 0 mA, 4= 20 to 4 mA.
P870 Fill Damping	10m/min	Rate of maximum fill rate (set above the actual fill rate of the vessel)
P871 Empty Damping	10m/min	Rate of maximum empty rate (set above the actual empty rate of the vessel)

The default values used for determining the **relay setpoints**, when setting **Alarm** relays, via the **Quick Setup** menu are entered as a % of span and are as follows.

RELAY FUNCTION	RELAY ID	ON SETPOINT	OFF SETPOINT
Alarm	HiHi	90%	85%
Alarm	High	85%	80%
Alarm	Low	10%	15%
Alarm	LoLo	5%	10%

### Exponential Devices

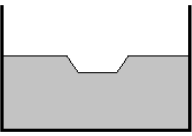
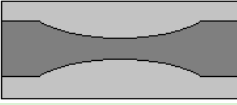
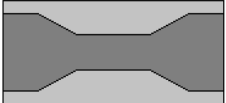
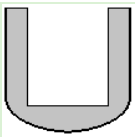
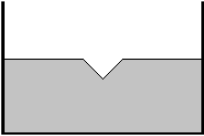
If the primary measuring device is a simple exponential device, then an exponent value is required. The Ultra 5 will automatically enter the exponent value for the device chosen as detailed in the table below.

EXPONENT TYPE	PMD SHAPE EXAMPLE	EXPONENT (P717)
Suppressed Rectangular Weir (Without end contractions)		1.50, automatically set by the unit.
Cipolletti (Trapezoidal) Weir		1.50, automatically set by the unit.
Venturi Flume		1.50, automatically set by the unit.
Parshall Flume		Automatically calculated according to the throat size.
Leopold Lagco Flume		1.55
V-Notch Weir		2.50
Other	As per manufacturer	Value to be set as required.
Contracted Rectangular Weir (With end contractions)		1.50

*Point of Measurement*

The transducer must be above the **maximum head P704** by at least the near **blanking distance P107**.

For **Suppressed/Contracted Rectangular, Trapezoidal and V-notch**, weirs, the head is measured **upstream** at a minimum distance of **3 times maximum head** from the weir plate to ensure the surface of the liquid is not affected by turbulence or drawdown. (See DRWG. 1)

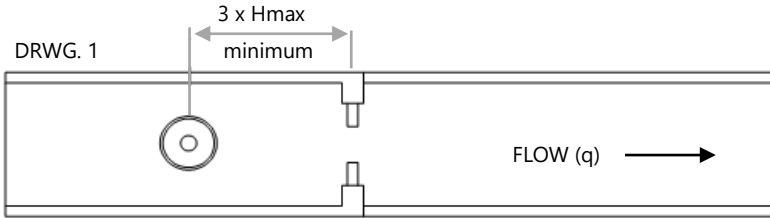

In the case of a **Venturi** flume the point of measurement should be **150 mm upstream** from the beginning of the **converging section** and for a **Parshall** flume **2/3 the length of the converging section** upstream of the **throat** section. (See DRWG 2 and 3).

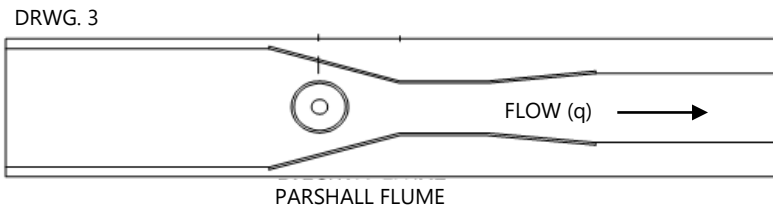
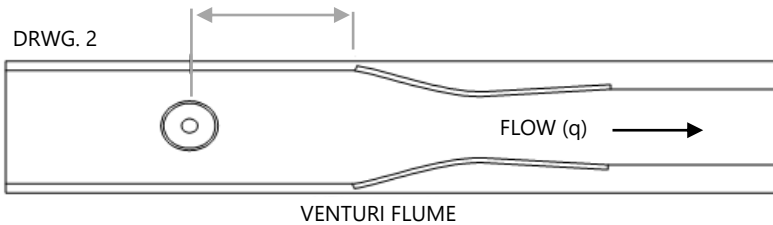

For a **Leopold Lagco** flume the head is measured at a point **upstream** of the beginning of the converging section as detailed in the table below. (See DRWG 4).

FLUME SIZE		POINT OF MEASUREMENT	
mm	inches	mm	inches
100 - 305	4 – 12	25	1.0
380	15	32	1.3
455	18	38	1.5
530	21	44	1.8
610	24	51	2.1
760	30	64	2.5
915	36	76	3.0
1065	42	89	3.5
1220	48	102	4.0
1370	54	114	4.5
1520	60	127	5.0
1675	66	140	5.5
1830	72	152	6.0

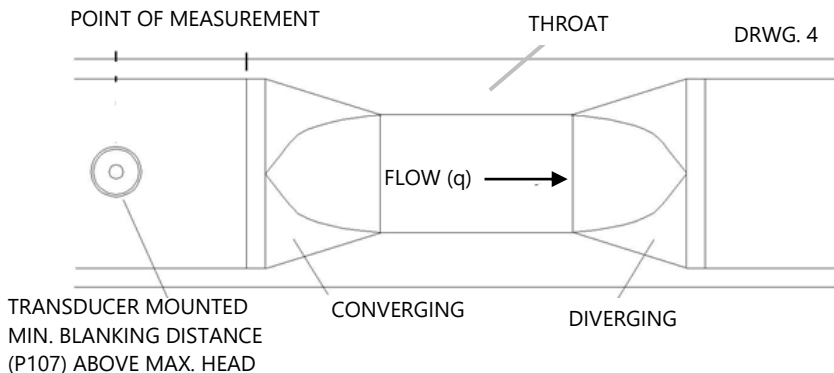

When any **Other** device is chosen please consult the manufacturer of the device for details of where the point of measurement should be located but ensure that it is chosen such that the surface of the liquid is not effected by turbulence or drawdown.

**Calculations**

*Absolute*

If the flow calculation is to be absolute P702 = 1 the flow will be calculated using the formula (s) as follows:

EXPONENT TYPE	FORMULA	EXPONENT	K FACTOR
Suppressed Rectangular Weir (Without end contractions)	$Q = KLh^*$ Where: Q=Flow K=K Factor L=Crest length of weir h=head *=exponent	1.50 Automatically selected by the Ultra 5	Automatically calculated, dependent on measurement, flow and time units chosen.
Cipolletti (Trapezoidal Weir)	$Q = KLh^*$ Where: Q=Flow K=K Factor L=Crest length of weir h=head *=exponent	1.50 Automatically selected by the Ultra 5	Automatically calculated, dependent on measurement, flow and time units chosen
Venturi Flume	$Q = Kh^*$ Where: Q=Flow K=K Factor h=head *=exponent	1.50 Automatically selected by the Ultra 5	Enter value of K Factor (P718) as required
Parshall Flume	$Q = Kh^*$ Where: Q=Flow K=K Factor h=head *=exponent	Automatically calculated, dependent on throat size (P719)	Automatically calculated, dependent on measurement, flow and time units chosen



EXPONENT TYPE	FORMULA	EXPONENT	K FACTOR
Leopold Lagco Flume	$Q = KD^{0.0953}h^x$ Where: Q =Flow K=K factor      D=pipe diameter h=head *=exponent	1.55 Automatically selected by the Ultra 5	Automatically calculated, dependent on measurement, flow and time units chosen
V-Notch Weir	$Q = Kh^x$ Where: Q =Flow K=K factor h=head *=exponent	2.50 Automatically selected by the Ultra 5	Automatically calculated, dependent on measurement flow and time units chosen.
Other	$Q = Kh^*$	Enter value as required	Enter value as required
Contracted Rectangular Weir (With end contractions)	$Q = K(L - 0.2 * h)h^*$ Where: Q=Flow K=K Factor L=Crest length of weir H=head *=exponent	1.50 Automatically selected by the Ultra 5	Automatically calculated, dependent on measurement flow and time units chosen.

### Ratiometric

If the flow calculation is to be **ratiometric P702 = 2** the flow will be calculated using the formula:  $q = q_{cal} (h/h_{cal})^x$

Where:

q = flowrate

**q<sub>cal</sub>** = **flowrate at maximum head (705)**

h = head

**h<sub>cal</sub>** = **maximum head (P704)**

**x** = exponent (determined as in absolute calculation above)

*Example 1 'V' Notch Weir*

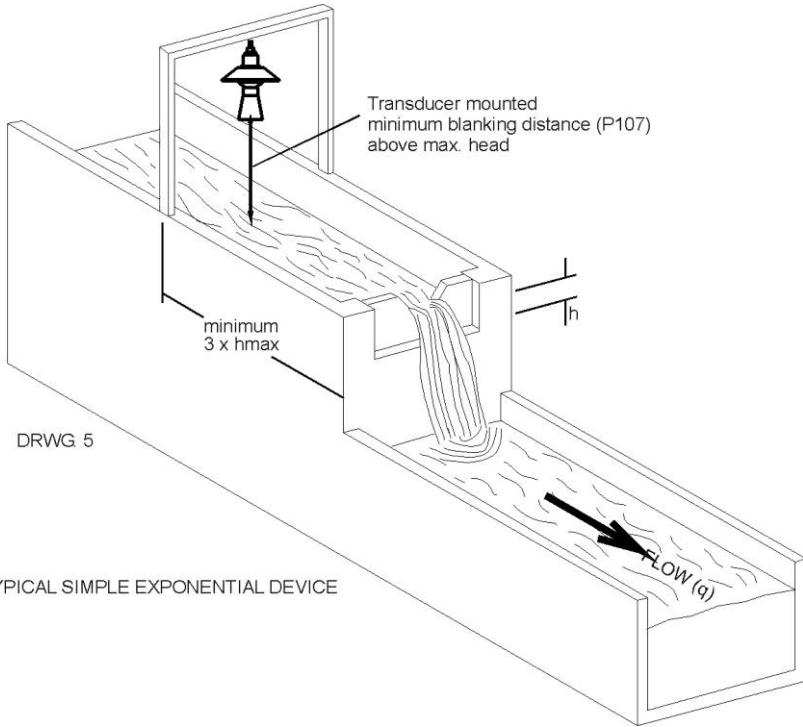

TYPICAL SIMPLE EXPONENTIAL DEVICE

In this example, it is required to calculate the flow through a Simple Exponential Device, which on this occasion is a V-Notch Weir. Ratiometric calculation will be used, to use the customers declared maximum flow, there is no requirement for alarms and the flow rate is to be displayed in litres/second. The totaliser is to record the flow in cubic metres but is not to be displayed during RUN.

The distance from the end of the transducer horn (dB Mach 3) to **zero** flow (**P105**) is 1 metre and **max head** (**P704**) is 0.4 metres, **maximum flow** (**P705**) is known to be 96.5 litres/second.

To program the Ultra 5 for **Example 1 V-Notch Weir** by using the **Quick Setup** menu proceed as follows. If required access the **Program Mode**, key in the **passcode** 1997 and press **ENTER**

Using the 'right' arrow key, go to the **Quick Setup** menu press **ENTER** and as prompted, by the questions, select the relevant option and press **ENTER**.

QUESTION	OPTION
PMD Type	1 = Exponent
Exponent	6 = V-Notch
Calculation	2 = Ratiometric
No. of alarms	0 = No alarms
Xducer	1 = dB Mach3
Volume units	1 = Litres
Time units	1 = Per second
Measurement units	1 = metres
Empty Level	1.00 metres
Minimum head	0.00 metres
Maximum head	0.40 metres
Totaliser enable	1 = On
Totaliser (R)	0 = No
Totaliser multiplier	7 = 1,000
Max flow	96.5

Programming is now complete, and the unit can now be returned to the run mode, press **CANCEL** until **Run Mode?** Is displayed on the LCD press **ENTER**, and the Ultra 5 will return to **Run Mode**.

**BS3680 Flumes (P700 = 2)**

*Point of Measurement*

The transducer must be above the **maximum head P704** by at least the near **blanking distance P107**.

For a **Rectangular** and **U-throated** flume, the head is measured at **3 to 4 times the maximum head upstream** from the beginning of the **converging section**, to ensure the surface of the liquid is not affected by turbulence. (See DRWG 6)

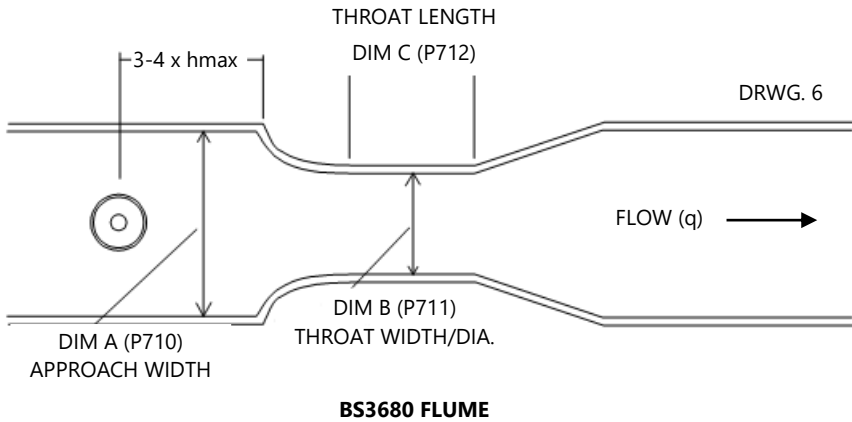

## Rectangular Flume Calculations

### Absolute

If the flow calculation is to be **absolute P702 = 1** the flow will be calculated using the formula:  $q = (2/3)^{1.5}gn^{0.5}C_sC_vC_dbh^{1.5}$

Where:

$q$  = flowrate

$gn$  = gravitational acceleration (nominal value = 980.66 cm/s<sup>2</sup>)

$C_s$  = **shape coefficient** (value = 1)

$C_v$  = **velocity coefficient** calculated by Ultra 5 (P721)

$C_d$  = **discharge coefficient** calculated by Ultra 5 (P722)

$b$  = **throat width P711**

$h$  = head

### Ratiometric

If the flow calculation is to be **ratiometric P702 = 2** the flow will be calculated using the formula:  $q = q_{cal}(C_v/C_{vcal})(C_d/C_{dcal})(h/h_{cal})^{1.5}$

Where:

$q$  = flowrate

$q_{cal}$  = **flowrate at maximum head P705**

$C_v$  = **velocity coefficient** calculated by Ultra 5 (P721)

$C_{vcal}$  = velocity coefficient at maximum head

$C_d$  = **discharge coefficient** calculated by Ultra 5 (P722)

$C_{dcal}$  = discharge coefficient at maximum head

$h$  = head

$h_{cal}$  = **maximum head P704**

### U-Throated Flume Calculations

#### Absolute

If the flow calculation is to be **absolute P702 = 1** the flow will be calculated using the formula:  $q = (2/3)^{1.5} g_n^{0.5} C_u C_v C_d b h^{1.5}$

Where:

$q$  = flowrate

$g_n$  = gravitational acceleration, (nominal value = 980.66 cm/s<sup>2</sup>)

$h$  = head

**C<sub>u</sub>** = **shape coefficient** calculated by Ultra 5 (P724)

**C<sub>v</sub>** = **velocity coefficient** calculated by Ultra 5 (P721)

**C<sub>d</sub>** = **discharge coefficient** calculated by Ultra 5 (P722)

**b** = **throat width P711**

#### Ratiometric

If the flow calculation is to be **ratiometric P702 = 2** the flow will be calculated using the formula:

$$q = q_{cal} (C_v / C_{vcal}) (C_d / C_{dcal}) (C_u / C_{ucal}) (h / h_{cal})^{1.5}$$

Where:

$q$  = flowrate

**q<sub>cal</sub>** = **flowrate at maximum head P705**

**C<sub>v</sub>** = **velocity coefficient** calculated by Ultra 5 (P721)

$C_{vcal}$  = velocity coefficient at maximum head

**C<sub>d</sub>** = **discharge coefficient** calculated by Ultra 5 (P722)

$C_{dcal}$  = discharge coefficient at maximum head

**C<sub>u</sub>** = **shape coefficient P724**

$C_{ucal}$  = shape coefficient at maximum head

$h$  = head **h<sub>cal</sub>** = **maximum head P704**

**Example 2 BS3680 U-Throated Flume**

In this example, it is required to calculate to BS3680 the flow through a U-Throated Flume without any hump. Absolute calculation will be used, and there is a requirement for an alarm to indicate a low flow condition which will be set to relay 1. The flow rate is to be displayed in cubic meters/hour and the totaliser is also to record the flow in cubic metres, the resettable totaliser is to be displayed during RUN.

The distance from the end of the transducer horn (dB Mach3) to **zero** flow (P105) is 1 metre and **max head (P704)** is 0.4 metres, **maximum flow(P705)** will be calculated by the Ultra 5 as 725.17 cubic metres/hour.

The dimensions of the flume are as follows:

<b>Approach Channel diameter (Dim "A") P710</b>	= 0.7m
<b>Throat diameter (Dim "B") P711</b>	= 0.5m
<b>Throat length (Dim "C") P712</b>	= 1m

To program the Ultra 5 for **Example 2 BS3680 U-Throated Flume** by using the **Quick Setup** menu proceed as follows. If required access the **Program Mode**, key in the passcode 1997 and press **ENTER**. Using the 'right' arrow key, go to the **Quick Setup** menu press **ENTER** and as prompted, select the relevant option and press **ENTER**.

QUESTION	OPTION
PMD Type	2 = 3680 Flume
3680 Flumes	3 = U-Throat
Calculation	1 = Absolute
No. of alarms	1 = 1 Alarm
Type alarm 1	2 = Low
Alarm No.1	1 = Set to relay 1
Transducer	9 = DUET
Volume units	2 = Cubic metres
Time Units	4 = Per hour
Measurement units	1 = Metres
Empty level	1.00m
Minimum head	0.00m
Maximum head	0.40m
Totaliser enabled	1 = On
Totaliser (R)	1 = Yes
Totaliser multiplier	7 = 1000
Approach dia. (Dim A)	0.70m
Throat dia. (Dim B)	0.50m
Throat length (Dim C)	1.00m

Programming is now complete, and the unit can now be returned to the run mode, press **CANCEL** until **Run Mode?** Is displayed on the LCD press **ENTER**, and the Ultra 5 will return to **Run Mode**.

### Important Notice

If relay setpoints do not meet the exact requirements of the application, they can be modified to suit by pressing ENTER when, "For More Options Hit Enter", is displayed, and entering new values to relay setpoints as required. Alternatively, access the setpoints by the main menu system or directly accessing the parameters.



### BS3680 Weirs (P700 = 3)

#### Point of Measurement

The transducer must be above the **maximum head P704** by at least the near **blanking distance P107**.

For a **Rectangular** and **V-notch** weir, the head is measured at a point 4 to 5 **times the maximum head upstream** from the weir plate, to ensure the surface of the liquid is not affected by turbulence or drawdown. (See DRWG 7)

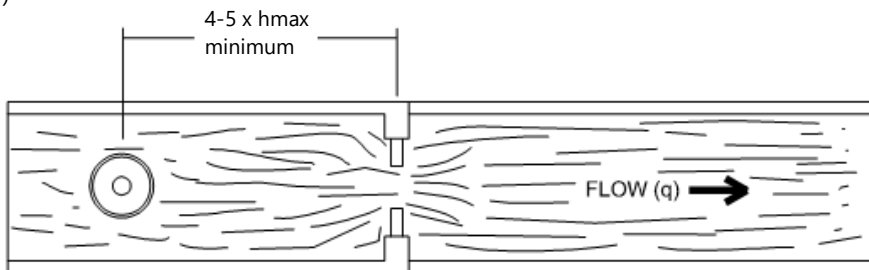

DRWG. 7

BS3680 WEIR

### Rectangular Weir Calculations

#### Absolute

If the flow calculation is to be **absolute P702 = 1** the flow will be calculated using the formula:  $q = C_e \frac{2}{3}(2gn)^{0.5} b_e h_e^{1.5}$

Where:

$q$  = flowrate

**C<sub>e</sub>** = **discharge coefficient** calculated by Ultra 5 (P723)

$gn$  = gravitational acceleration (nominal value = 980.66 cm/s<sup>2</sup>)

$b_e$  = effective approach width where **b** is **approach width (Dim "A") P710**

$h_e$  = effective head

*Ratiometric*

If the flow calculation is to be **ratiometric P702 = 2** the flow will be calculated using the formula:  $q = q_{cal}C_e/C_{ecal}(h_e/h_{ecal})^{1.5}$

Where:

q = flowrate

**q<sub>cal</sub>** = **flowrate at maximum head P705**

**C<sub>e</sub>** = **discharge coefficient** calculated by Ultra 5 (P723)

C<sub>ecal</sub> = discharge coefficient at maximum head

h<sub>e</sub> = effective head

h<sub>ecal</sub> = effective head at maximum head

*V-Notch Weir Calculations*

*Absolute*

If the flow calculation is to be **absolute P702 = 1** the flow will be calculated using the formula:  $q = C_e 8/15 \tan(\theta/2) (2gn)^{0.5} h^{2.5}$

Where:

q = flowrate

**C<sub>e</sub>** = **discharge coefficient** calculated by the Ultra 5 (P723)

theta = V-notch angle

gn = gravitational acceleration (nominal value = 980.66 cm/s<sup>2</sup>)

h = head

The Ultra 5 pre-sets the angle (theta) on selection of the chosen device this angle is **90°** for a BS 3680 **full 90°V notch** weir, **53° 8 minutes** in the case of the BS3680 **half 90°V notch** weir and **28° 4 minutes** in the case of the BS3680 **quarter 90°V notch**.

*Ratiometric*

If the flow calculation is to be **ratiometric P702 = 2** the flow will be calculated using the formula:  $q = q_{cal}C_e(h)/C_e(h_{cal})(h/h_{cal})^{2.5}$

Where:

q = flowrate

**q<sub>cal</sub>** = **flowrate at maximum head P705**

C<sub>e</sub>(h) = discharge coefficient for head

C<sub>e</sub>(h<sub>cal</sub>) = discharge coefficient for maximum head

h = head

**h<sub>cal</sub>** = **maximum head P704**

### Example 3 BS3680 Rectangular Weir

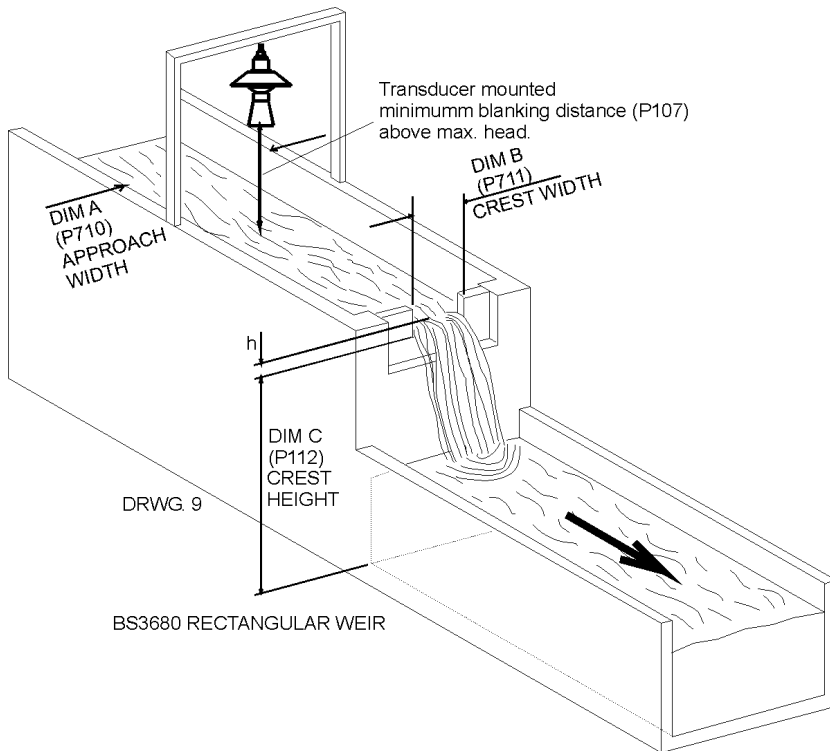

In this example, it is required to calculate the flow through a BS3680 Rectangular weir. Absolute calculation will be used, and there is a requirement for an alarm to indicate a high flow condition to be set to relay 3. The flow rate is required to be displayed in litres/minute and the totaliser is to record the flow in cubic metres, the resettable totaliser is to be displayed during RUN.

The distance from the end of the transducer horn to **zero flow (P105)** is 1 metre and **max head (P704)** is 0.4 metres, **maximum flow (P705)**.

**Approach width (Dim "A") P710 = 0.5 m**

**Crest width (Dim "B") P711 = 0.3 m**

**Crest Height (Dim "C") P712 = 0.3 m**

To program the Ultra 5 for **Example 3 BS3680 Weir** by using the **Quick Setup** menu proceed as follows. If required access the **Program Mode**, key in the **passcode** 1997 and press **ENTER**.

Using the 'right' arrow key, go to the **Quick Setup** menu press **ENTER** and as prompted, by the questions, select the relevant option and press **ENTER**.

QUESTION	OPTION
PMD Type	3 = 3680 Weir
3680 Weir	1 = Rectangular
Calculation	1 = Absolute
No. of alarms	1 = 1 Alarm
Type alarm 1	1 = High
Alarm No.1	1 = Set to relay 3
Transducer	1 = dB Mach3
Volume units	1 = Litres
Time Units	1 = Second
Measurement units	1 = Metres
Empty level	1.00m
Minimum head	0.00m
Maximum head	0.40m
Totaliser enabled	1 = On
Totaliser (R)	1 = Yes
Totaliser multiplier	7 = 1000
Approach dia. (Dim A)	0.50m
Throat dia. (Dim B)	0.30m
Throat length (Dim C)	0.30m

Programming is now complete, and the unit can now be returned to the run mode, press **CANCEL** until **Run Mode?** Is displayed on the LCD press **ENTER**, and the Ultra 5 will return to **Run Mode**.

### Important Notice

If relay setpoints do not meet the exact requirements of the application, they can be modified to suit by pressing ENTER when, "For More Options Hit Enter", is displayed, and entering new values to relay setpoints as required. Alternatively, access the setpoints by the main menu system or directly accessing the parameters.

## BS3680 Rectangular Broad Crested Weir

### Point of Measurement

The transducer must be above the **maximum head P704** by at least the near **blanking distance P107**.

The head is measured at a point 3 to 4 **times** the **maximum head upstream** from the weir crest, to ensure the surface of the liquid is not affected by turbulence or drawdown.

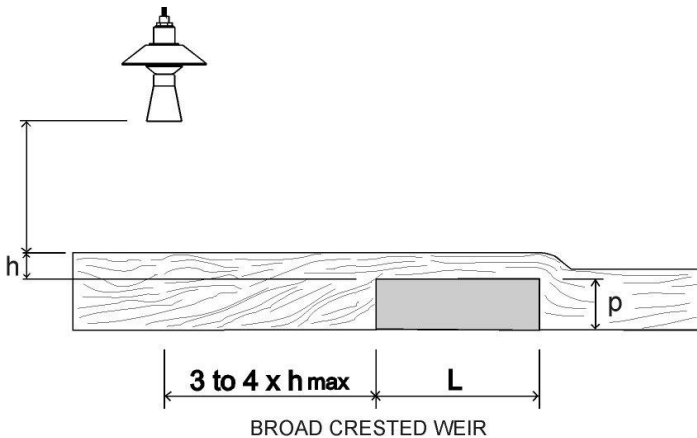

## Rectangular Broad Crested Weir Calculations

### Calculations

#### Absolute

If the flow calculation is to be **absolute P702 = 1** the flow will be calculated using the formula:  $q = (2/3)^{1.5} C_e b (gh^3)^{0.5}$

Where:

q = flowrate

**Ce = discharge coefficient** calculated by Ultra 5 **P723**

b = approach width **P710**

g = gravitational acceleration (nominal value = 980.66 cm/s<sup>2</sup>)

h = head

*Ratiometric*

If the flow calculation is to be **ratiometric P702 = 2** the flow will be calculated using the formula:  $q = q_{cal} C_e / C_{ecal} (h_e / h_{ecal})^{1.5}$

Where:

q = flowrate

**q<sub>cal</sub>** = **flowrate at maximum head P705**

**C<sub>e</sub>** = **discharge coefficient** calculated by Ultra 5 **P723**

C<sub>ecal</sub> = discharge coefficient at maximum head

h<sub>e</sub> = effective head

h<sub>ecal</sub> = effective head at maximum head

## Velocity Area

The calculation of flow using Velocity Area is only possible when the optional current input is available to provide an input from a velocity sensing device which provides a signal proportional to flow. (Please consult Pulsar for availability).

### Point of Measurement

The transducer must be above the **maximum head P704** by at least the near **blanking distance P107**.

For all **Velocity/area** applications the point at which the head is measured should be chosen such that the surface of the liquid is not affected by turbulence. (See DRWG 10, 11, 12 and 13)

### U – Channel

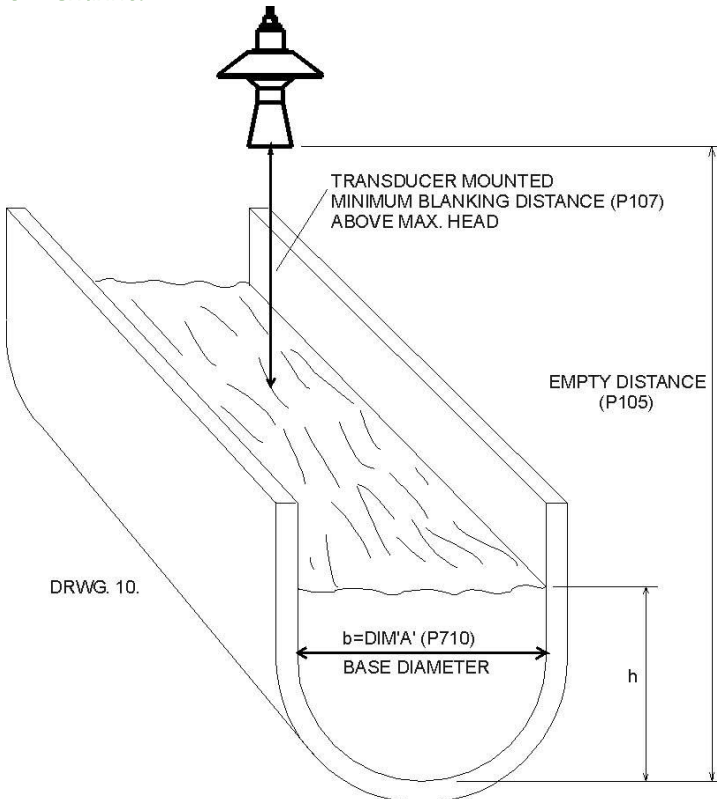

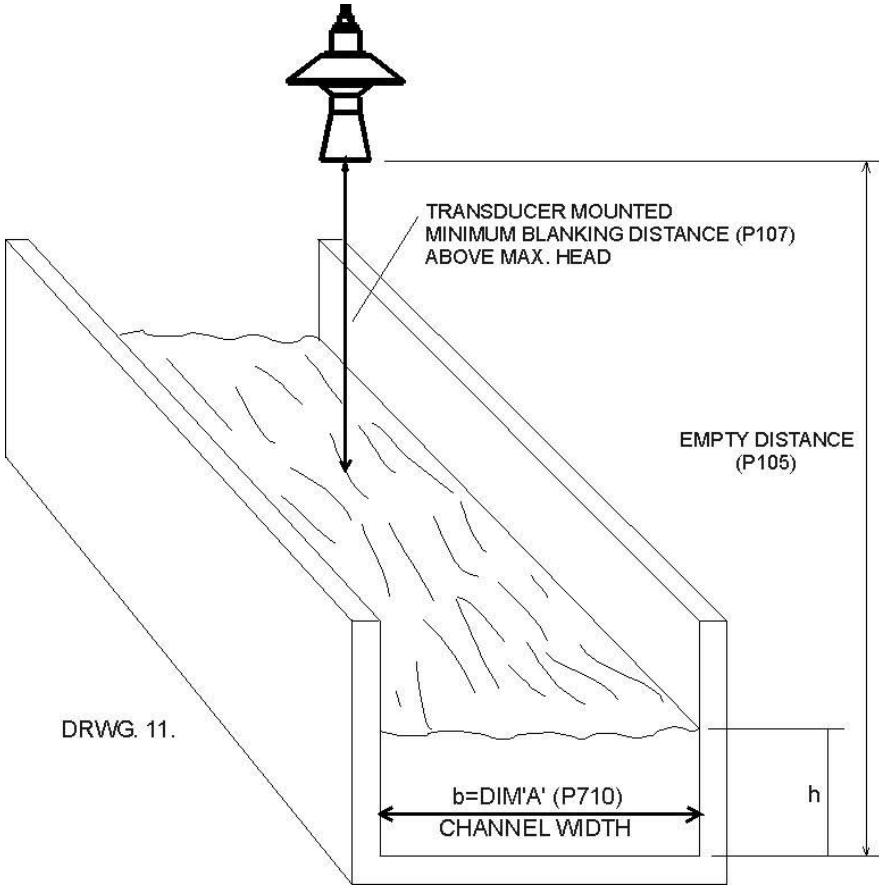

### Calculations

#### Absolute

**Rectangular and U-Channel** If the flow calculation is to be **absolute P702 = 1** the flow will be calculated using the formula:  $q = v \times b \times h$

Where:

$q$  = flowrate

$v$  = velocity

**$b$  = channel width/diameter (Dim "A") P710**

$h$  = head

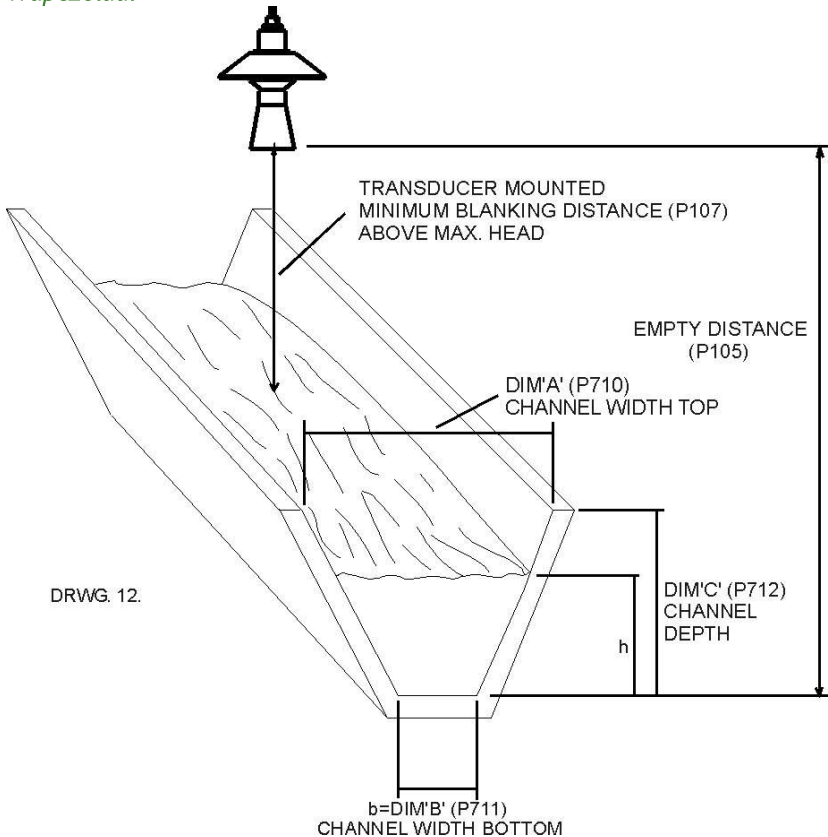

*Trapezoidal*

Where:

q = flowrate

v = velocity

h = head

**b = base width (Dim "B") P711**

m = side slope calculated from

**m = (B - b)/d** where **B = channel top width (Dim "A") P710,**

**b = base width (Dim "B") P711**

**d = depth of channel (Dim "C") P712**

**Round Pipe**

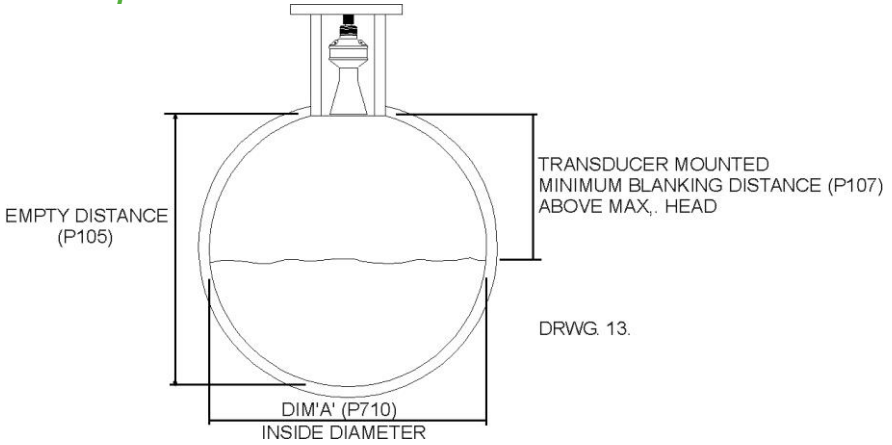

If the flow calculation is to be **absolute P702 = 1** the flow will be calculated using the formula:  $q = va(h)$

Where:

- q = flowrate
- v = velocity
- a(h) = area at head

## Special Devices

### Point of Measurement

The transducer must be above the **maximum head P704** by at least the near **blanking distance P107**.

In the case of a **Palmer Bowlus** flume the point of head measurement should be **half** the value of **Dim "A" P710 upstream** of the device.

For a **H-Flume** the head measurement is taken at a point **downstream** from the flume entrance as detailed in the table below:

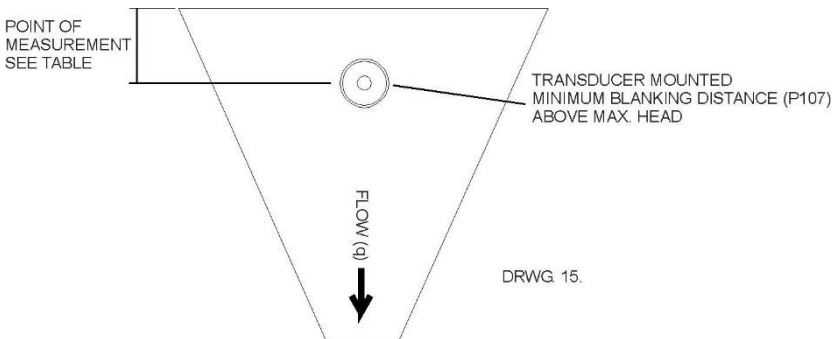

FLUME SIZE-DIM A (P710)		POINT OF MEASUREMENT	
cm	feet	cm	inches
15.25	0.5	4.7	1.88
23.00	0.75	6.7	2.69
30.05	1.0	9.1	3.63
45.70	1.5	13.5	5.378
61.00	2.0	17.9	7.19
76.20	2.5	22.5	9.00
91.45	3.0	27.2	10.88
137.15	4.5	40.5	16.19

**V-notch angle** weirs, the head is measured **upstream** of the weir plate at a minimum distance of **3 times maximum head** to ensure the surface of the liquid is not affected by turbulence or drawdown. See Exponential devices, above, for further details.

### **Palmer Bowlus and H-Flume Calculations**

#### *Absolute*

If the flow calculation is to be **absolute P702 = 1** the flow will be calculated using the formula:  $q = f(h)$

Where:

$q$  = flowrate

$f$  = is an 8<sup>th</sup> degree polynomial solution for  $h$  (head)

#### *Ratiometric*

If the flow calculation is to be ratiometric **P702 = 2** the flow will be calculated using the formula:  $q = q_{cal} f(h)/f(h_{cal})$

Where:

$q$  = flowrate

$q_{cal}$  = flowrate at maximum head **P705**

$f(h)$  = a polynomial solution for  $h$  (head)

$f(h_{cal})$  = a polynomial solution for  $h_{cal}$  (maximum head)

### **V-Notch Angle Weir (Non-BS 3680) Calculations**

#### *Absolute*

If the flow calculation is to be absolute P702 = 1 the flow will be calculated using the formula:  $q = C_e 8/15 \tan(\theta/2)(2gn)^{0.5}(h + kh)^{2.5}$

Where:  $q$  = flowrate

$C_e$  = discharge coefficient calculated by Ultra 5 (P723)

$\theta$  = V-notch angle

$gn$  = gravitational acceleration

$h$  = head

$kh$  = compensated head

#### *Ratiometric*

If the flow calculation is to be **ratiometric P702 = 2** the flow will be calculated using the formula:  $q = q_{cal} (h + kh/h_{cal} + kh)^{2.5}$

Where:  $q$  = flowrate

$q_{cal}$  = **flowrate at maximum head P705**

$h$  = head

$kh$  = compensated head

### **Universal Calculations (P700=6)**

#### *Point of Measurement*

The transducer must be above the **maximum head P704** by at least the near **blanking distance P107**.

For all **Universal** calculation applications, the point at which the head is measured should be chosen such that the surface of the liquid is not affected by turbulence.

#### *Absolute*

If the flow calculation is to be absolute P702 = 1 the flow will be calculated using the formula:  $q = q(h)$

Where:  $q$  = flowrate

$q(h)$  = flowrate for head

The desired number of Breakpoints, (P730 - P793) are to be entered in pairs in values of head and corresponding flow. (Minimum of 2 pairs of Breakpoints is required).

## CHAPTER 8 PARAMETER GUIDE

This chapter describes all the parameters in your Ultra 5, as they appear in the menu system.

### Menu System

Shown below is a set of charts to show you how all the various functions and features can be found using the menu system.

For further details and a full description of all parameters refer to the **Parameter Listings and Descriptions** section of this chapter.

### Top Level Menu

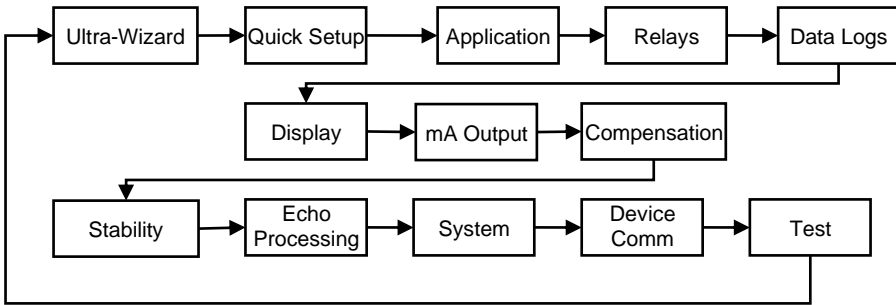

## Application Menu

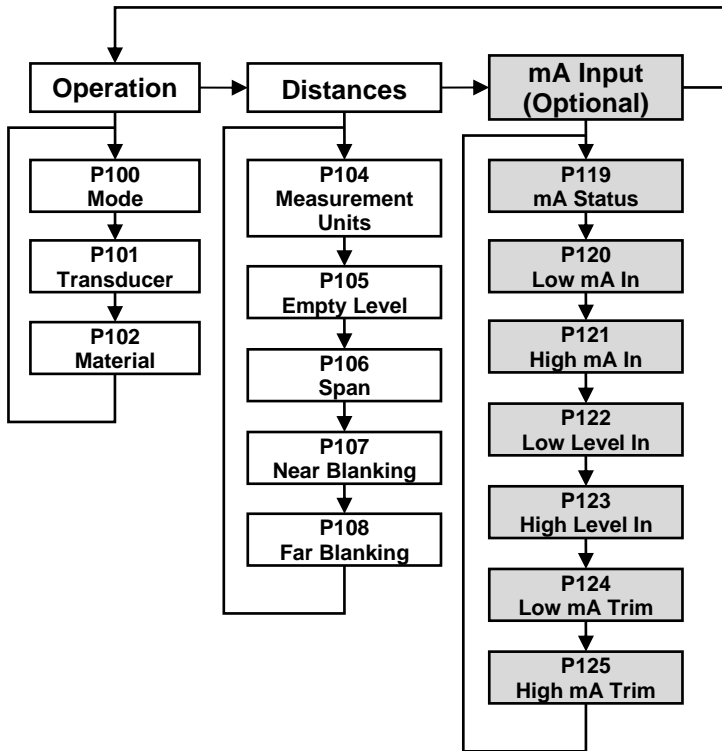

**Relays Menu**

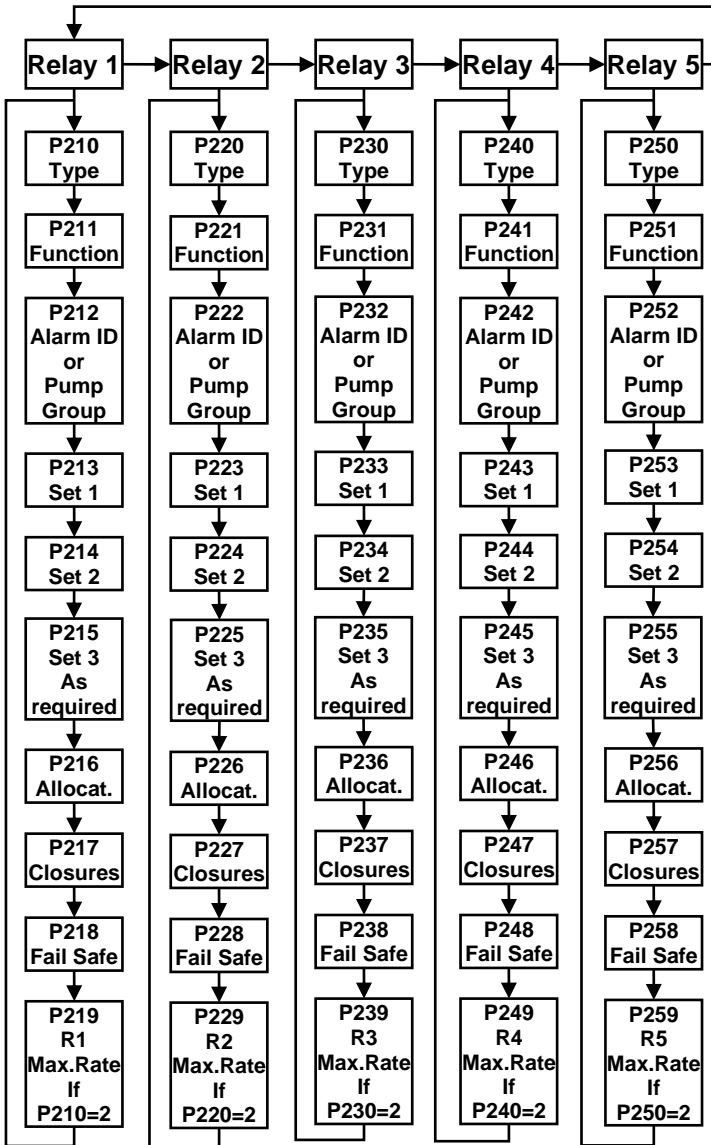



Data Logs Menu

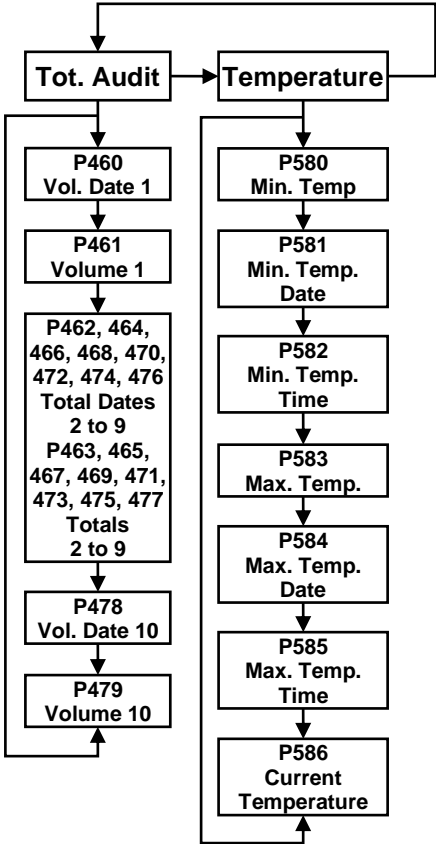

**Volume: Available when Ultra Wizard = Volume**

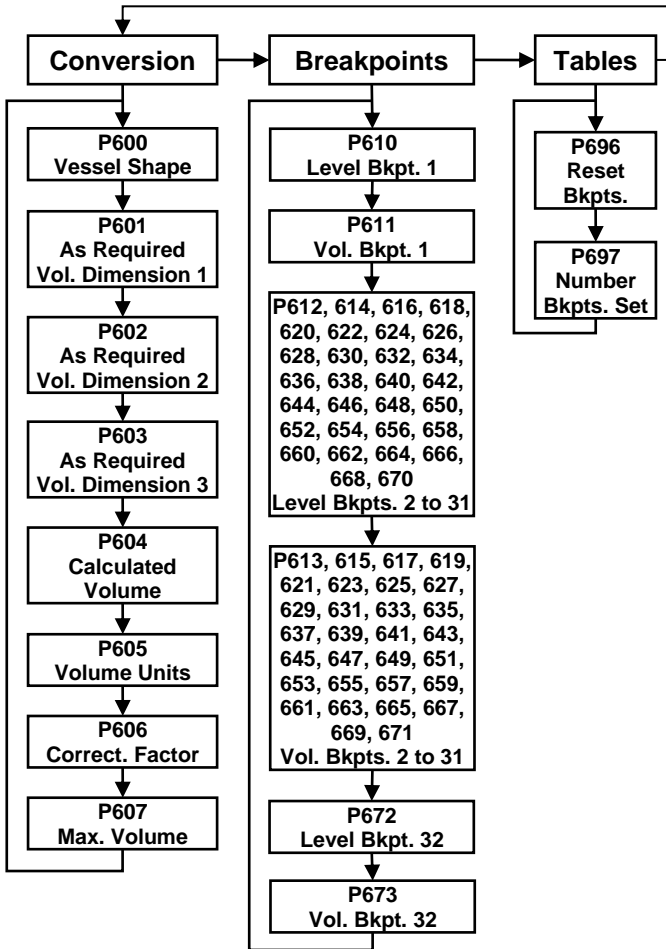

**OCM: Available when Ultra Wizard = OCM**

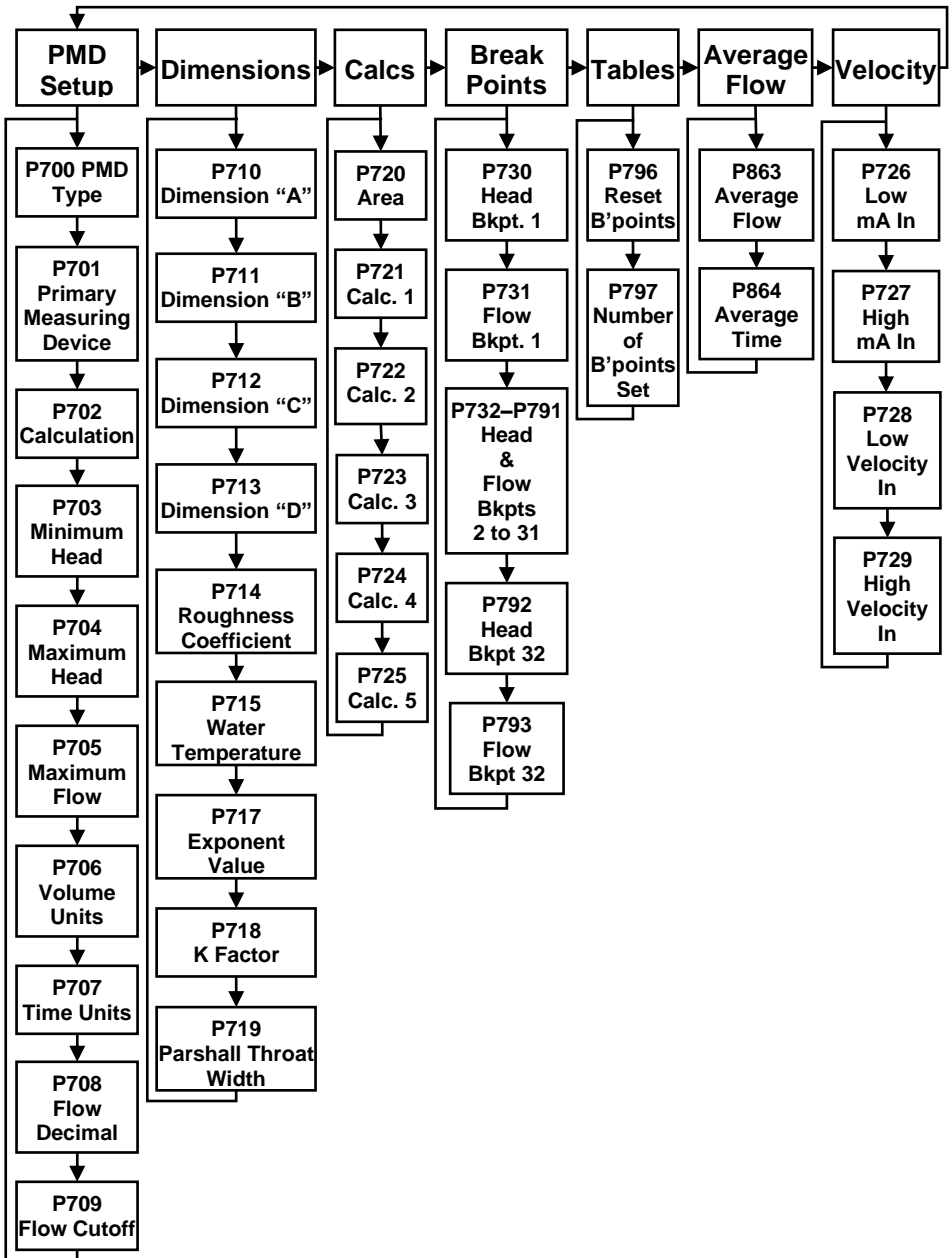

## Display Menu

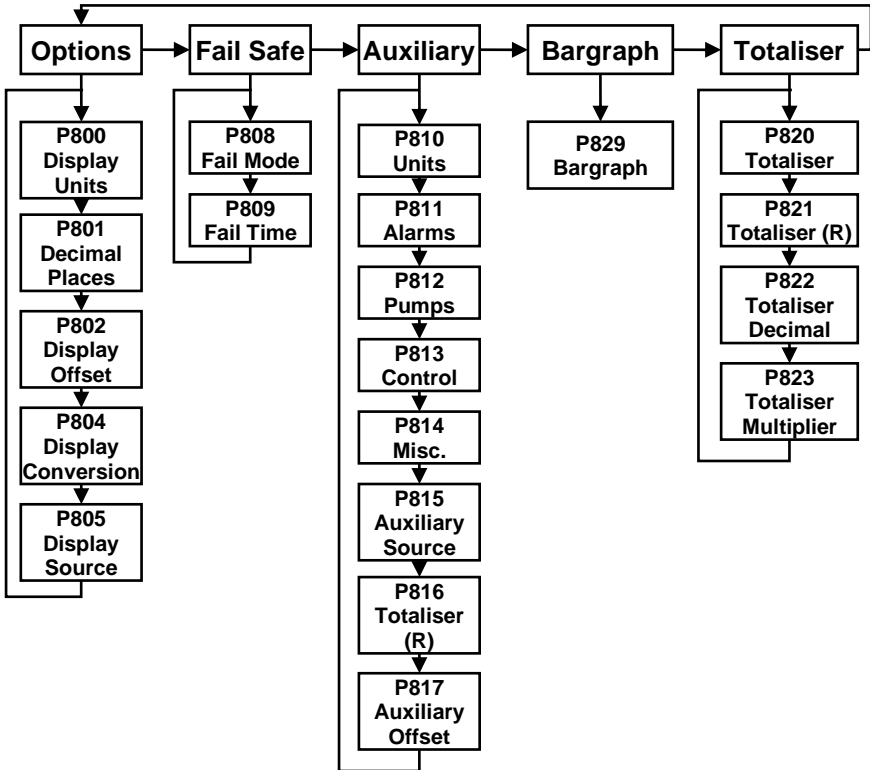

### Important Notice

Totaliser options only available when Ultra Wizard = Flow

*mA Output Menu*

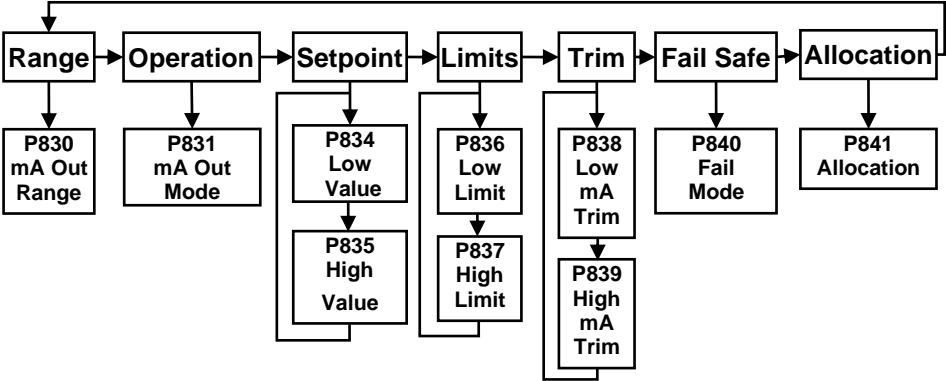

*Compensation Menu*

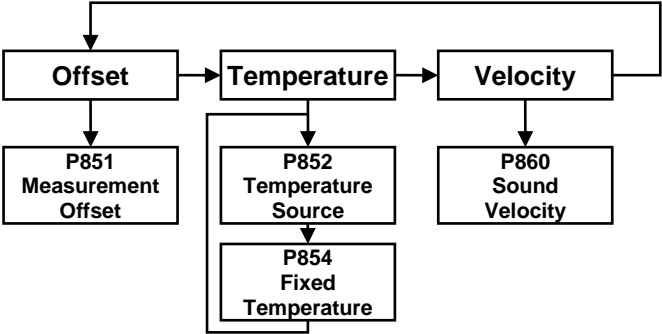

**Stability Menu**

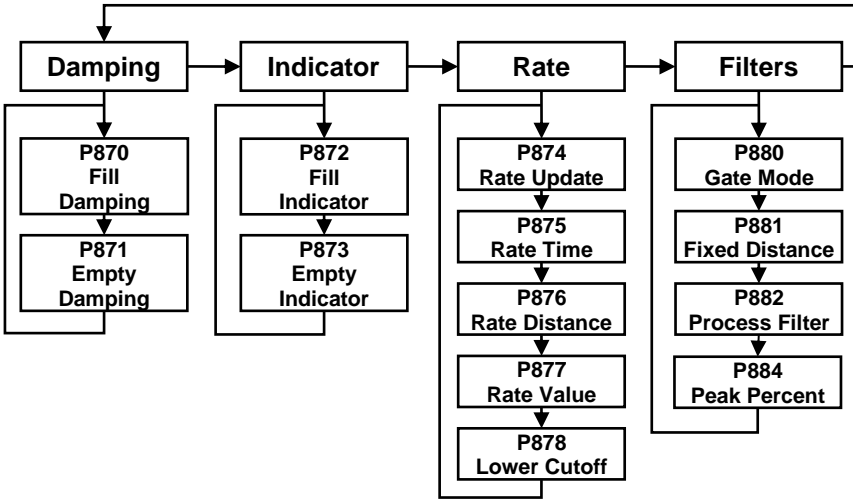

**Echo Processing Menu**

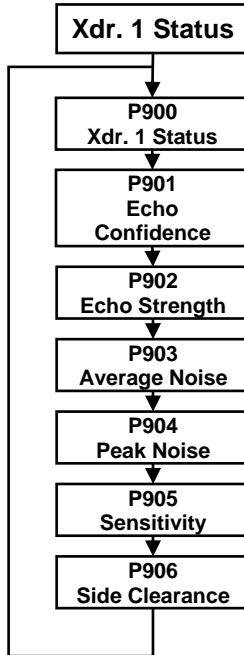

**System Menu**

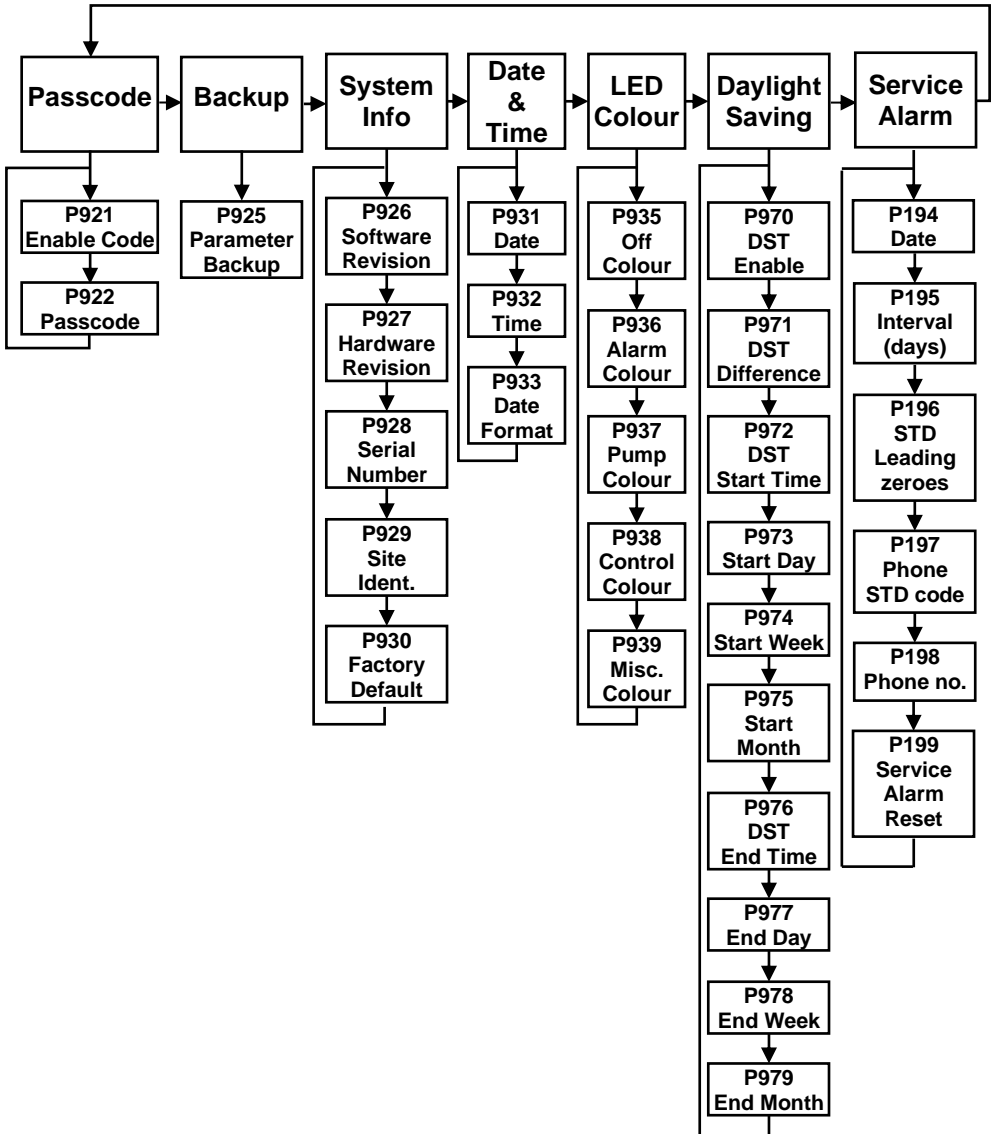

**Device Comm Menu**

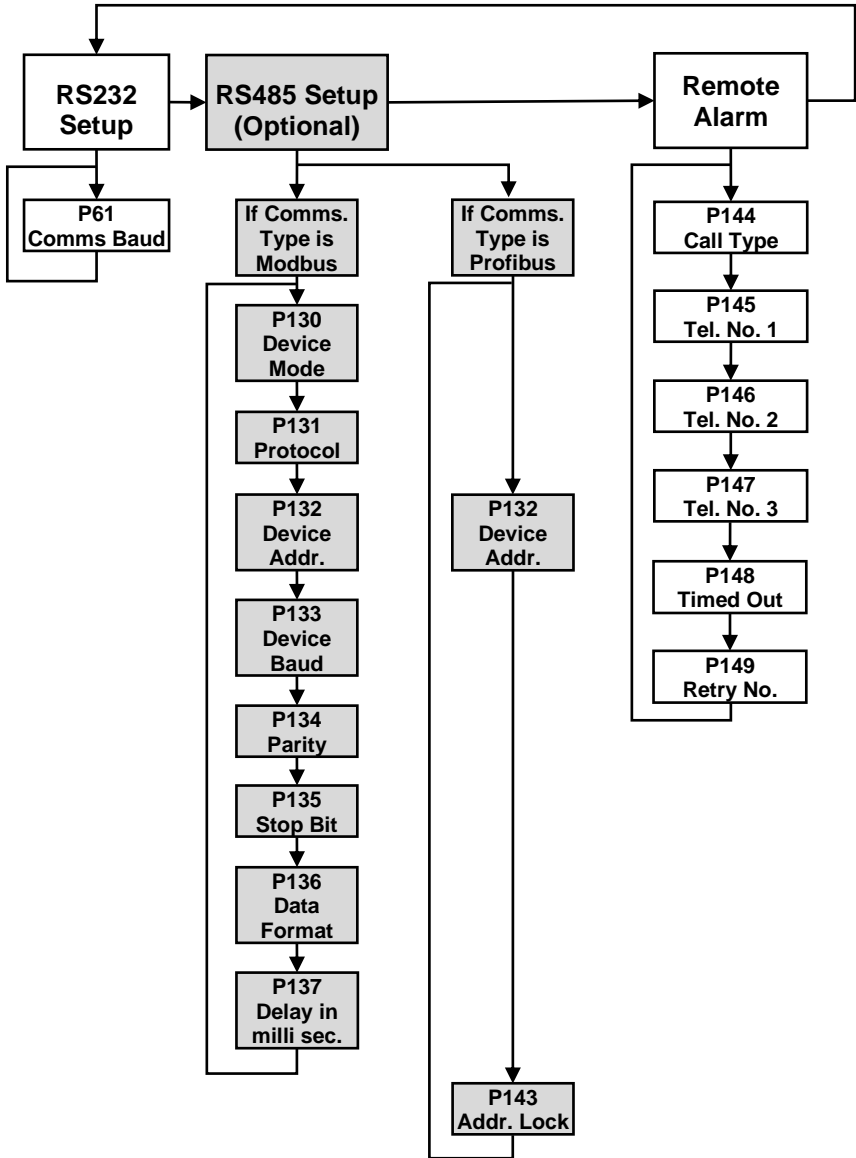



*Test Menu*

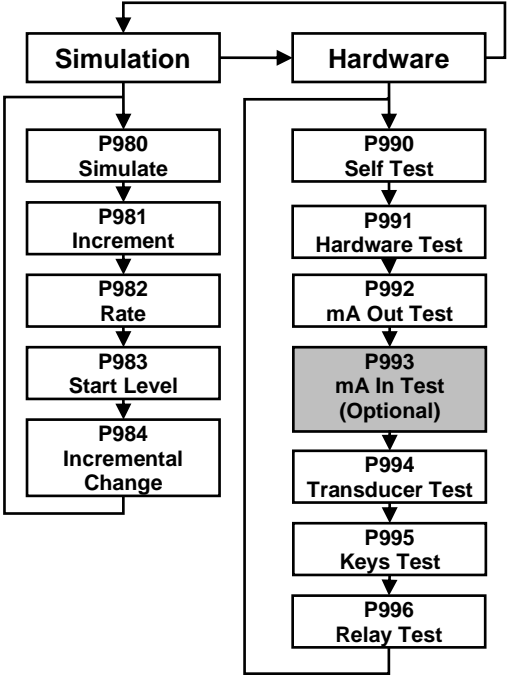

**Application Parameters**

**Operation**

*P100 Mode of Operation*

This parameter sets the mode of operation, when in run mode, and can be set to one of the following:

OPTION	DESCRIPTION
<b>When Ultra Wizard = 1 Level/Volume, 2 Pump/Diff or 3 Flow</b>	
1 = Distance (Default)	Display shows the distance from the transducer face to the surface of the material measured.
2 = Level	Shows how full a vessel is.
3 = Space	Shows how empty a vessel is.
<b>When Ultra Wizard = 1 Level/Volume</b>	
4 = Average Level	Display shows the average level of two points of measurement.
5 = Volume	Display shows volume of the vessel
6 = Volume (Average)	Display shows volume of the vessel as the average between two transducers.
<b>When Ultra Wizard = 2 Pump/Differential</b>	
4 = Average Level	Display shows the <b>average</b> level of 2 points of measure.
5 - Differential	Display shows the <b>Differential</b> level between 2 points of measure.
<b>When Ultra Wizard = 3 Flow</b>	
4 = OCM Head	Display shows how high the head is.
5 = OCM Flow	Display shows the instantaneous flow

*P101 Xducer (Transducer)*

This parameter should be set to the transducer being used with the unit, and can be set to one of the following:

OPTION	DESCRIPTION
<b>When Ultra Wizard = 1 Level/Volume, 2 Pump</b>	
0 = Auxiliary <b>(Optional)</b>	Use the optional mA input (Please consult Pulsar for availability).
1 = dB3	Transducer is a dB3. Range = 0 to 3 metres
<b>2 = dB6 (default)</b>	Transducer is a dB6. Range = 0.3 to 6 metres
3 = dB10	Transducer is a dB10. Range = 0.3 to 10 metres
4 = dB15	Transducer is a dB15. Range = 0.5 to 15 metres
5 = dB25	Transducer is a dB25. Range = 0.6 to 25 metres
6 = dB40	Transducer is a dB40. Range = 1.2 to 40 metres
7 = dB56	Transducer is a dB56. Range = 0.2 to 6 metres
8 = dB Mach3	Transducer is a dB Mach3. Range 0.3 to 2.425 metres
10 = dB50	Transducer is a dB50. Range = 2 to 50 metres
<b>When Ultra Wizard = 3 Flow</b>	
0 = Auxiliary <b>(Optional)</b>	Use the optional mA input (Please consult Pulsar for availability)
<b>1 = dB Mach3 (Default)</b>	Transducer is a dB Mach3. Range = 0 to 2.425 metres
2 = dB6	Transducer is a dB6. Range = 0.3 to 6 metres
3 = dB10	Transducer is a dB10. Range = 0.3 to 10 metres
4 = dB15	Transducer is a dB15. Range = 0.5 to 15 metres
7 = dB56	Transducer is a dB56. Range = 0.2 to 6 metres
<b>Available for all Ultra Wizard options</b>	
*11 = dB R16	Transducer is a mmWave radar. Range 0.077 to 16 metres
*12 = dB R8	Transducer is a mmWave radar. Range 0.077 to 8 metres

**Important Notice**

\*Please consult your local Pulsar distributor for the versions of firmware that the mmWAVE radars are available in.

*P102 Material*

This parameter should be set to the type of material being monitored.

OPTION	DESCRIPTION
<b>1 = Liquid (Default)</b>	Used for liquids and flat solid materials.
2 = Solid	Used for sold material that is heaped or at an angle.
3 = Closed Tank	Use for applications within a closed tank or where a secondary echo response may become focused to create a larger echo than the first.

*P103 Input 2 (Optional)*

The 4-20 mA input is available as an option (Consult Pulsar for details of availability), and can be used to replace the transducer for applications where an ultrasonic transducer cannot be used.

Use this parameter to set the second input device when using in Average or Differential Mode, and P101 Transducer = 1 (Optional Auxiliary Input).

OPTION	DESCRIPTION
<b>0 = None (Default)</b>	Use the optional mA input (Please consult Pulsar for availability).
1 = dB3	Transducer is a dB3. Range = 0 to 3 metres
2 = dB6	Transducer is a dB6. Range = 0.3 to 6 metres
3 = dB10	Transducer is a dB10. Range = 0.3 to 10 metres
4 = dB15	Transducer is a dB15. Range = 0.5 to 15 metres
5 = dB25	Transducer is a dB25. Range = 0.6 to 25 metres
6 = dB40	Transducer is a dB40. Range = 1.2 to 40 metres
7 = dB56	Transducer is a dB56. Range = 0.2 to 6 metres
8 = dBMach3	Transducer is a dBMach3. Range 0.3 to 2.425 metres
10 = dB50	Transducer is a dB50. Range = 2 to 50 metres
*11 = dB16	Transducer is a mmWave Radar. Range = 0.077 to 16 metres
*12 = dB8	Transducer is a mmWave Radar. Range = 0.077 to 8 metres

\*The signal emanates from the curved face of the Radar, but for the purposes of measurement it is taken from the drip shield.

## Dimensions

### P104 Measurement Units

This parameter sets the units you want to use for programming and display.

OPTION	DESCRIPTION
1 = metres (Default)	All units of measurement are <b>Metres</b>
2 = cm	All units of measurement are <b>Centimetres</b>
3 = mm	All units of measurement are <b>Millimetres</b>
4 = feet	All units of measurement are <b>Feet</b>
5 = inches	All units of measurement are <b>Inches</b>

### P105 Empty Level

This parameter is to be set to the **maximum distance** from the **face** of the transducer to the **empty point**, in **P104 Measurement Units**. Note this value affects span as well, (see the following important information notices), so should be set before span.

#### Important Notice

When using the dB Mach 3 the empty distance is measured from the end of the horn to the empty point in P104 Measurement Units.

#### Important Notice

When changing the Empty Distance (P105) you can also recalculate the values for the Span so that it equals the empty distance (P105) minus Near Blanking (P107) and the Relay Setpoints, so that they remain at the same percentage values of the empty distance as they were before you changed the empty distance (P105). You will be asked the question "Recalculate Span?" if you choose yes (enter 1), then the span will be recalculated. Any other answer will leave the span at its original value. You will then be asked if you want to "Recalculate Setpoints?", if you choose yes (enter 1), then all Relay Setpoints will be recalculated as a percentage of the new empty distance. Any other answer will leave the setpoints at their original values.

### P106 Span

This parameter should be set to the maximum distance from the **Empty Level (P105)** to the maximum material level. It is automatically set to be equal to the **Empty Level (P105)** less the **Near Blanking distance (P107)** when you set the empty level.

*P107 Span*

This parameter is the distance from the face of the transducer that is not measurable and is pre-set to the minimum value dependant on the **Transducer (P101)** selected. It should not be set to less than this figure, but can be increased, typically to ignore close in obstructions.

TRANSDUCER	NEAR BLANKING DISTANCE
P101 = dB Mach3	Default blanking distance = 0.00 metres
P101 = dB3	Default blanking distance = 0.125 metres
P101 = dB6	Default blanking distance = 0.30 metres
P101 = dB10	Default blanking distance = 0.30 metres
P101 = dB15	Default blanking distance = 0.50 metres
P101 = dB25	Default blanking distance = 0.60 metres
P101 = dB40	Default blanking distance = 1.20 metres
P101 = dB56	Default blanking distance = 0.20 metres
P101 = dB50	Default blanking distance = 2.00 metres
P101 = dB R16	Default blanking distance = *0.077 metres
P101 = dB R8	Default blanking distance = *0.077 metres

\*The signal emanates from the curved face of the radar, but for the purposes of measurement it is taken from the drip shield.

*P108 Far Blanking Distance*

This is the distance (as a percentage of the **empty level P105**) beyond the empty point that the unit will be able to measure, and by default is pre-set to 20% of the empty level.

If the surface being monitored can be extended beyond the **empty level (P105)** then the far blanking distance can be increased to a max. of 100% of the empty level, provided it does not exceed the max range of the transducer being used. This parameter is always entered as a % of the empty level.

## **mA Input**

The **4-20 mA (Auxiliary) input** is available as an **option** (Consult Pulsar for details of availability), and can be used to replace the transducer for applications where an ultrasonic transducer cannot be used.

### *P119 mA Status*

#### **If P101 (Xducer) = 1 (Auxiliary)**

This indicates the status of the Auxiliary input if selected

<b>OPTION</b>	<b>DESCRIPTION</b>
<b>1 = mA OK (Default)</b>	mA Input present and functioning correctly
1 = mA Open	No input (device) is being detected
2 = mA Short	Input is indicating a fault condition

### *P120 Low mA in*

This parameter sets the current input figure that is used to represent empty when using the optional current input, instead of an ultrasonic transducer.

**Default = 4ma**

### *P121 High mA in*

This parameter sets the current input figure that is used to represent span when using the optional current input, instead of an ultrasonic transducer.

**Default= 20mA**

### *P122 Low Level in.*

This parameter sets the distance to empty point when using the optional current input, (Aux. input) instead of an ultrasonic transducer.

### *P123 High Level in*

This parameter sets the distance that is full (span) when using the optional current input, (Aux. input) instead of an ultrasonic transducer.

### *P124 Low mA Trim*

This parameter allows you to "calibrate" the *Ultra 5* to the **Low mA Input** from the device being used. If the expected low value, from the device connected to the mA Input, is not displayed, then you can trim it using this parameter.

### *P125 High mA Trim*

This parameter allows you to "calibrate" the *Ultra 5* to the **High mA Input** from the device being used. If the expected high value, from the device

connected to the mA Input, is not displayed, then you can trim it using this parameter.

### **Relay Parameters**

All relay related parameters are prefixed with a **2\*\***.

The second digit of the three-figure parameter number denotes the relay number as follows:

**21\*** parameters for Relay **1**

**22\*** parameters for Relay **2**

**23\*** parameters for Relay **3**

**24\*** parameters for Relay **4**

**25\*** parameters for Relay **5**

The third digit selects specific parameter for the setting of the relays, which can be selected individually and results in the following parameter numbers for each relay:

Relay 1    **210** to **219**

Relay 2    **220** to **229**

Relay 3    **230** to **239**

Relay 4    **240** to **249**

Relay 5    **250** to **259**



*P210, 220, 230, 240, 250 - Relay Type*

This parameter defines what type each relay should be, see the table below for available options:

OPTION	DESCRIPTION
<b>0 = Not in use (Default)</b>	Relay is not in use or programmed and the LED will always be off.
1 = Alarm	Relay is programmed as an alarm relay, which will <b>de-energise ON</b> , and <b>energise OFF</b> . This will ensure an alarm is raised if the power fails to the unit.
2 = Pump	Relay is programmed as a pump relay, which will <b>energise ON</b> , and <b>de-energise OFF</b> .
3 = Control	Relay is programmed as a control relay, which will <b>energise ON</b> , and <b>de-energise OFF</b> .
4 = Miscellaneous	Relay is programmed as a miscellaneous relay, which will <b>energise ON</b> , and <b>de-energise OFF</b> .
<b>When Ultra Wizard = 1 Level/Volume</b>	
2 = General Control	Relay is programmed as a general control relay, which will <b>energise ON</b> , and <b>de-energise OFF</b> .
<b>When Ultra Wizard = 2 Pump/Differential</b>	
5 = Pump by time	Relay is programmed as a pump relay, which will energise at its <b>ON level</b> setpoint, and de-energise at its <b>OFF level</b> setpoint or after a predetermined <b>time</b> period, <b>whichever occurs first</b> .

**Alarms**

**P210, 220, 230, 240, 250 = 1 (Alarm)**

The **second parameter** for each relay determines the **function** of the alarm.

*P211, 221, 231, 241, 251 – Relay Function*

OPTION	DESCRIPTION
<b>0 = Off (Default)</b>	Relay will not operate.
1 = Level	Alarm is based on the level in the vessel, and the type of level alarm (P212, 222, 232, 233, 243, 253) and two setpoints must be set (P223, 223, 233 & 214, 224, 234, 244, 254). Setpoints are entered in display units or % of span as referenced to empty level.
2 = Rate of Change	Alarm is based on the rate of change of level in the vessel, and the type of rate of change alarm (212, 222, 232, 242, 252), and two setpoints must be set (213, 223, & 214, 224, 234, 244, 254). Setpoints are entered in Display Units per minute or % of span per minute and a negative value should be entered for a Rate Alarm on a de-creasing level, and a positive value for an increasing level.
3 = Temperature	Alarm is based on the temperature, and the type of temperature alarm (P212, 222, 232, 242, 252) and two setpoints must be set (P213, 223, 233 & P214, 224, 234, 244, 254). The temperature used depends on the temperature source selected (P852). Setpoints are entered in °C.
4 = Loss of Echo	Alarm is raised if the <b>Failsafe Timer (P809)</b> expires. No setpoints required.
5 = Loss of Clock	Alarm is raised if the expires. No setpoints required.
<b>When Ultra Wizard = 2 Pump Differential and Pump Efficiency Enabled</b>	
6 = Pump Efficiency	When Pump Efficiency is enabled, Alarm is based on the Efficiency of the pump which is allocated to the relay I.D. (P212, 222, 232, 242, 252) and two setpoints must be set (P213, 223, 233, 243, 253 & P214, 224, 234, 244, 254). Setpoints are entered in %.
14 = Service Alarm (Available in firmware v7.4.3 and greater)	Alarm is raised when the service alarm date/time interval expires. This is set in ' <b>System &gt; Service Alarm &gt; Date (P194) &gt; Interval (P195)</b> '. The alarm trigger is automatic in the unit and is set at 12 noon, meaning that the alarm will activate at 12 noon on the date programmed into the unit when the service is now due. No setpoints are required.

### Important Notice

The Loss of Echo, and Loss of Clock will also be shown on the display as “Lost Echo”, and “Lost Clock” respectively.

The third parameter for each relay determines the **Alarm ID** for the relay you wish to set.

*P212, 222, 232, 242, 252 – Relay Alarm ID*

**When P211, 221, 231, 241, 251 = 4 (Loss of Echo) or 5 (Loss of Clock).**

This parameter has no function and will not be displayed.

**P211, 221, 231, 241, 251 = 1 (Level), 2 = Rate of Change or 3 (Temp)**

This parameter defines which **alarm type**, or **identification**, the relay should respond to, as follows:

OPTION	DESCRIPTION	SETPOINTS
<b>1 = General (Default)</b>	Relay goes “ON” when the value reaches the ON setpoint and goes “OFF” when the value reaches the OFF setpoint.	P213, 223, 233, 243, 253 is <b>ON</b> Setpoint; P214, 224, 234, 244, 254 is <b>OFF</b> Setpoint
2 = High	Relay goes “ON” when the value rises to the ON setpoint and goes “OFF” when the value lowers to the OFF setpoint.	<b>ON&gt;OFF</b> Relay Setpoints P213, 223, 233, 243, 253 and P214, 224, 234, 244, 254. Setpoints can be set in any order as the unit ‘knows’ that you are setting a high-level alarm.
3 = HiHi	Same as 2 = High, but different	identifier
4 = Low	Relay goes “ON” when the value lowers to the ON setpoint and goes “OFF” when the value rises to the OFF setpoint.	<b>ON&lt;OFF</b> Relay Setpoints P213, 223, 233, 243, 253 and P214, 224, 234, 244, 254. Setpoints can be set in any order as the unit ‘knows’ that you are setting a low-level alarm.

OPTION	DESCRIPTION	SETPOINTS
5 = LoLo	Same as 4 = Lo, but different identifier	
6 = In bounds	Relay goes "ON" if value is inside the zone between the two setpoints.	Relay Setpoints, P213, 223, 233, 243, 253 and P214, 224, 234, 244, 254 can be set in any order as the unit 'knows' that you are setting an inbounds alarm.
7 = Out of bounds	Relay goes "ON" if value is outside the zone between the two setpoints.	Relay Setpoints P213, 223, 233, 243, 253 and P214, 224, 234, 244, 254 can be set in any order as the unit 'knows' that you are setting an out of bounds alarm.

**When P211, 221, 231, 241, 251 = 6 Pump Efficiency**

This parameter assigns the **alarm** to the appropriate **pump relay** as detailed below.

OPTION	DESCRIPTION
<b>0 = Off (Default)</b>	Relay will not operate
1 = Relay 1	Alarm is assigned to <b>pump</b> on Relay 1
2 = Relay 2	Alarm is assigned to <b>pump</b> on Relay 2
3 = Relay 3	Alarm is assigned to <b>pump</b> on Relay 3
4 = Relay 4	Alarm is assigned to <b>pump</b> on Relay 4
5 = Relay 5	Alarm is assigned to <b>pump</b> on Relay 5
7 = All	Alarm is assigned to <b>relays</b> designated as <b>pump</b>

The **fourth parameter** and the **fifth parameter** for each relay set the **Alarm "ON"** and **"OFF"** points. For a **high alarm**, the **"ON"** is set **higher than "OFF"**. For **low alarm**, then **"ON"** is set **lower than "OFF"**. See the appropriate **alarm ID**, table (**P212, 222, 232**) for further information.

**When P211, 221, 231, 241, 251 = 4 (Loss of Echo) or 5 (Loss of Clock)**

This parameter has no function and will not be displayed.

**When P211, 221, 231, 241, 251 = 1 (Level), 2 (Rate of Change) or 3**

**(Temperature)***P213, P223, P233, 243, 253 - Relay Setpoint 1*

Determines the "ON" or "OFF" point for the alarm according to the ID selected.

*P214, P224, P234, 244, 254 - Relay Setpoint 2*

Determines the "ON" or "OFF" point for the alarm according to the ID selected.

**Important Notice**

**Setpoints** are entered in values according to the **function** selected.

**Level** - entered in Display Units or % of span as referenced to Empty Level.

**Rate of Change** - entered in Display Units per minute or % of span per minute.

For an alarm on an increasing level enter setpoints as a positive value, for an alarm on a decreasing level enter setpoints as a negative value.

**Temperature** - entered in °C.

See the appropriate **alarm function**, table (**P211, 221, 231, 241 and 251**) for further information.



To set figures in % press the  hotkey to show and enter % figure, relative to empty level.

**General Control**

**When Ultra Wizard = 1 Level/Volume**

**P210, 220, 230, 240, 250 = 2 (General Control)**

When a relay is being set up as a **control** relay, the **second parameter** that will be displayed in the menu determines its **function**.

OPTIONS	DESCRIPTION
<b>0 = Off (Default)</b>	Relay is always de-energised
1 = On	Control is based on the level in the vessel. All general controls are used to assist each other (run at the same time) and each general control has its own "ON" and "OFF" setpoints.

The **third parameter** has **no function** when **general control** is chosen and will not be displayed.

The **fourth parameter** and **fifth parameter** are set to determine the switch points for the **general control** relay. See the **general control** function, table (P211, 221, 231, 241, 251) for further information.

**Important Notice**

The General control relays are started and stopped at the "ON" and "OFF" setpoints. To **control down** (reduce level) then set "ON" **higher than** "OFF". To **control up** (increase level) then set "ON" **lower than** "OFF".

*P213, P223, P233, 243, 253 - Relay Setpoint 1*

This parameter determines the "ON" point for the general control relay, relay Setpoints are entered in values of Measurement Units (P104)

*P214, P224, P234, 244, 254 - Relay Setpoint 2*

This parameter determines the "OFF" point for the general control relay, relay Setpoints are entered in values of Measurement Units (P104)

*P219, P229, P239, 249, 259 - Relay Max.Rate*

This parameter will allow a **General Control Relay** to be **switched** at a pre-determined **Rate of change of Level**, irrespective of the "ON" level setpoint P213, 223, 233, 243, 253. Once a General Control relay has been switched "ON" by the pre-determined **Rate of Change**, it will remain energised until the level reaches the "OFF" level setpoint **P214, 224, 234, 244, 254**.

Max. Rate is entered in Measurement Units (P104) per minute and can be entered as either positive (increasing level) or negative (decreasing level) values.

*Pumps***When Ultra Wizard = 2 Pump****P210, 220, 230, 240, 250= 2 (Pump)**

When a relay is being used for a **pump** function, the **second parameter** determines the **pump duty** that will be used to determine the operating cycle.

*P211, 221, 231, 241, 251 – Relay Function*

This parameter defines which **pump duty** the relay should respond to as follows:

PUMP DUTY	DESCRIPTION
<b>0 = Off (Default)</b>	Relay is always de-energised
1 = Fixed duty assist	All pumps are used to assist each other (run at the same time) and each pump has its own setpoints. (P213, 223, 233, 243, 253 & P214, 224, 234, 244, 254).
2 = Fixed duty backup	If a pump fails to meet the demand (due to malfunction, intake blockage etc.), then it is stopped, and another pump shall take over. Each pump has its own setpoints. (P213, 223, 233, 243, 253 & P214, 224, 234, 244, 254).
3 = Alternate duty assist	All pumps are used to assist each other (run at the same time) and each pump has its own setpoints, (P213, 223, 233, 243, 253 & P214, 224, 234, 244, 254). but each time all pumps have stopped, then the setpoints are sequentially rotated between the pumps to ensure equal pump use.

PUMP DUTY	DESCRIPTION
4 = Alternate duty backup	<p>If a pump fails to meet the demand (due to malfunction, intake blockage etc.), then it is stopped, and another pump shall take over. Each pump has its own setpoints, (P213, 223, 233, 243, 253 &amp; P214, 224, 234, 244, 254). but each time all pumps have stopped, then the setpoints are sequentially rotated between the pumps to ensure equal pump use.</p>
5 = Duty backup and assist	<p>First pump comes on, if it cannot cope, it goes off and next pump comes on (duty backup). This continues until the last pump comes on and if it cannot cope the first pump comes back on to assist the last pump (duty assist) if the level continues to rise all other pumps will come on (assist) in turn until the level decreases to the pump off points. Each pump has its own setpoints, (P213, 223, 233, 243, 253 &amp; P214, 224, 234, 244, 254).</p>
6 = Service ratio duty assist	<p>All pumps are used to assist each other (run at the same time) and each pump has its own setpoints (P213, 223, 233, 243, 253 &amp; P214, 224, 234, 244, 254). And a service ratio setting. The third setpoint (P215, 225, 235, 245, 255) is used to set the service ratio. Each time a pump is required to start then the pump with the least running hours (with respect to the service ratio) is started (i.e. the setpoints are re-assigned accordingly). For example, if two pumps A and B have the service ratio set to 2 and 1 respectively, then pump A will operate for twice as many hours as pump B.</p>



PUMP DUTY	DESCRIPTION
7 = Service ratio duty backup	The first pump switched on is the first pump to be switched off, regardless of the set points, so the setpoints are dynamically changed to enable this. If a pump fails to meet the demand (due to malfunction, intake blockage and so on), then it is stopped, and another pump shall take over. Each time a pump is required to start then the pump with the least running hours (with respect to the service ratio) is started (i.e. the setpoints are re-assigned accordingly). Each pump has its own setpoints (P213, 223, 233 & P214, 224, 234, 244, 254). The third setpoint (P215, 225, 235, 245, 255) is used to set the service ratio. E.g., if two pumps A and B have the service ratio set to 2 and 1 respectively, then pump A will operate for twice as many hours as pump B.
8 = <b>First On First Off</b> Alternate duty assist	The first pump switched on is the first pump to be switched off, etc. regardless of the set points, so the setpoints are dynamically changed to enable this.
9 = Service Ratio Standby	When a service ratio duty is being used, on all other pumps in use, the standby pump can be started on a ratio basis only, when it will assume the setpoints of the next pump to start. The third setpoint (P215, 225, 235, 245, 255) is used to set the service ratio.
10 = Two Pump Sets	There are four pumps. Two rotate their start-up sequence with each other. If the two pumps cannot keep up, the level rise to the setpoints of the other two pumps which take over and rotate their sequence with each other.

### Important Notice

The pumps are started and stopped at the "ON" and "OFF" setpoints. To **pump down** (reduce level) then set "ON" higher than "OFF". To **pump up** (increase level) then set "ON" lower than "OFF".

The **third parameter** for each relay determines the pump group. You can have two groups of pumps, and all similar duties within that group will operate together.

*P212, 222, 232, 242, 252 – Relay Pump Group*

By **default**, all pump groups are set to **1**, but if you want to have another group, then set this parameter to 2, for each pump relay that should operate together as part of a second group.

The **fourth parameter** and the **fifth parameter** for each relay set the **pump “ON”** and **“OFF”** points, which are entered in **Measurement units P104**. For **pump down** the **“ON”** is set **higher than “OFF”**. For **pump up** then **“ON”** is set **lower than “OFF”**. See the appropriate **pump duty**, function table (**P212, 222, 232, 242, 252**) for further information.

*P213, 223, 233, 243, 253 – Relay Setpoint 1*

This parameter determines the **‘ON’** point of the pump.

*P214, 224, 234, 244, 254 – Relay Setpoint 2*

This parameter determines the **‘OFF’** point of the pump.

The **sixth parameter** will determine the **service ratio** that will be used to switch the pump, when **pump duty** selected is a Service Ratio duty.

**P210, 220, 230, 240, 250 = 6, 7 or 9 (Service ratio)**

*P215, 225, 235, 245, 255 – Relay Setpoint 3*

This parameter determines the Service Ratio in values of %. See the appropriate **pump duty** function, table (**P211, 221, 231, 241, 251**), for further information.

*P219, 229, 239, 249, 259 – Relay Max Rate*

This parameter will allow a **pump** to be **switched** at a pre-determined **Rate of change of Level**, irrespective of the **“ON”** level setpoint P213, 223, 233, 243, 253. Once a pump relay has been switched **“ON”** by the pre-determined **Rate of Change**, it will remain energised until the level reaches the **“OFF”** level setpoint **P214, 224, 234, 244, 254**.

Max. Rate is entered in Measurement Units (P104) per minute and can be entered as either positive (increasing level) or negative (decreasing level) values.

## Control

### P210, 220, 230, 240, 250 = 3 (Control)

When a relay is being set as a **control** relay, the second parameter that will be displayed in the menu determines its **function**.

### P211, P221, P231, 241, 251 - Relay Function,

This function allows the relay to be assigned to specific **control** functions and mainly work in relation to time.

OPTIONS	DESCRIPTION
<b>0 = Off (Default)</b>	Relay is always de-energised
1 = Time	Relay will <b>energise "ON"</b> after the <b>Cycle time</b> that is set in Relay <b>Setpoint 2</b> (P214, 224, 234). And turns " <b>OFF</b> ", <b>de-energises</b> , after the <b>On-Time Period</b> that is set in Relay <b>Setpoint 1</b> (P213, 223, 233, 243, 253)
<b>When Ultra Wizard = 2 Pump/Differential</b>	
2 = Storm	Relay will <b>energise "ON"</b> when storm conditions are in effect and, <b>de-energise "OFF"</b> when storm conditions cease. Two setpoints are required, Upper Storm " <b>ON</b> ", (P213, 223, 233, 243, 253) and Lower Storm, " <b>OFF</b> " (P214, 224, 234, 244, 254). This allows the relay to be used to activate a device because of high levels such as a storm condition e.g. opening a gate valve to divert storm overflow into a holding vessel.
3 = Aeration	Relay will <b>energise "ON"</b> after each <b>Cycle time</b> as set in Relay <b>Setpoint 2</b> (P214, 224, 234, 244, 254). And turns " <b>OFF</b> ", <b>de-energises</b> , after the set <b>On Time Period</b> as set in Relay <b>Setpoint 1</b> (P213, 223, 233, 243,253). This can be used to activate a device based upon elapsed time since <b>All Pumps</b> have been " <b>OFF</b> ", such as the introduction of fresh air to reduce gas concentration.

OPTIONS	DESCRIPTION
<p>4 = Flush Valve</p>	<p>Relay will <b>energise "ON"</b> when Flush condition is in effect and goes off when Flush condition is cleared. A relay being used for Flush Valve/Pump must be assigned to one of the main pumps in use. Flush relay <b>Alarm ID</b> (P212, 222, 232, 242, 252) is used to enter the <b>relay number</b>, to which the <b>assigned pump is connected</b>.</p> <p>Flush Valve/Pump relay requires three setpoints. The first set point (P213, 223, 233, 243, 253) determines the <b>Flush Interval</b>, which is the number of main <b>pump cycles</b> that should occur before the Flush Valve/Pump operates. The second setpoint (P214, 224, 234, 244, 254), sets the number of <b>Flush cycles</b> the Flush Valve/Pump will operate for. This means that the Flush Valve will be operated for several main pump starts (<b>Flush Cycles</b>) after which the Flush Valve activity will cease until the <b>Flush Interval</b> comes around again. Setpoint three of the Flush Valve/Pump relay sets the <b>Flush Duration</b>, (P215, 225, 235, 245, 235) this is the duration for Flush Cycle, in seconds.</p>
<p>5 = Step Time</p> <p><b>When Ultra Wizard = 3 Flow Then</b></p> <p>2 = Step Time</p>	<p>Step Time Control allows relays to be used to control a device, such as a motorised valve or gate, to maintain the level within two predetermined points. Relays will <b>energise "ON"</b> when Step Time condition is in effect and <b>de-energises "OFF"</b> when Step Time goes off. One relay will be required to control an increase in level, ('open' the device) and a second relay is required to control a decrease in level, ('close' the device). <b>Alarm ID</b> (P212, 222, 232, 242, 252) is used to assign the relay to control either the <b>open</b> or <b>close</b> condition. Step Time Control relay requires three setpoints. The first set point (P213, 223, 233, 243, 253) determines the <b>level</b>, at which the relay is to be activated, (N.B. level setpoint for <b>open</b> relay, <b>increase</b> the level, must be <b>lower than</b> the setpoint for the <b>close</b> relay, <b>decrease</b> the level). The relay will <b>energise "ON"</b> after the <b>Limit time</b> that is set in Relay <b>Setpoint 3</b> (P215, 225, 235, 245, 255). And turns <b>"OFF", de-energises</b>, after the <b>Drive Period</b> that is set in Relay <b>Setpoint 2</b> (P214, 224, 234, 244, 254).</p>

OPTIONS	DESCRIPTION
6 = Differential Control	Relay will <b>energise "ON"</b> when a differential condition is in effect and, <b>de-energise "OFF"</b> when the differential conditions cease. Two setpoints are required, <b>Differential control "ON"</b> , (P213, 223, 233, 243, 253) and <b>Differential control, "OFF"</b> (P214, 224, 234, 244, 254). This allows the relay to be used to activate a device because of a differential level, between two points e.g. operate a rake on a screen.

The **third parameter** for each relay determines the **assignment or condition** of the relay, where required.

*P212, P222, P232, P242, P252 - Relay Alarm ID/Pump Group,*

**When Ultra Wizard = 2 Pump Differential**

*P211, 221, 231, 241, 251 = 1, 2, 3 or 6*

This parameter has no function and will not be displayed.

*P211, 221, 231, 241, 251 = 4 (Flush Valve)*

If the relay is selected for Flush Valve/Pump, then this parameter is used to determine to which pump the Flush function is assigned. Enter the **relay number to which the assigned pump is connected**.

*P211, 221, 231, 241, 251 = 5 (Step Time)*

If the relay is selected for Step Time, then this parameter is used to assign the relay to the 0 = **Open** condition (increase level) or 1 = **Close** condition (decrease level).

**When Ultra Wizard = 3 Flow**

*P211, 221, 231, 241, 251 = 2 (Step Time)*

If the relay is selected for Step Time, then this parameter is used to assign the relay to the 0 = **Open** condition (increase level) or 1 = **Close** condition (decrease level).

*P213, P223, P233, 243, 253 - Relay Setpoint 1*

This parameter will determine the "level" at which the relay will become active. Relay Setpoint 1 is entered in values of Measurement Units (P104)

The **fourth parameter**, **fifth parameter** and **sixth parameter** are set to determine the switch points, "ON" and "OFF" for the relay and where required the order of start. See control function, table (P211, 221, 231) for further information.

**When Ultra Wizard = 2 Pump/Differentia**

*P213, P223, P233, P243, P253 Relay Setpoint 1*

**P211, 221, 231, 241, 251 =1 (Time)**

This parameter determines the "Time Period" that the relay will remain "ON". Relay Setpoints are entered in Minutes.

See the appropriate relay Function tables (**P211, 221, 231, 241, 251**) for further information.

**P211, 221, 231, 241, 251 =2 (Storm)**

Relay Setpoint 1 is entered in values of Measurement Units (P104)

See the appropriate relay function tables (**P211, 221, 231, 241, 251**) for further information.

**P211, 221, 231, 241, 251 =3 (Aeration)**

Relay Setpoint 1 is entered in Minutes to set Cycle Time

See the appropriate relay Function tables (**P211, 221, 231, 241, 251**) for further information.

**P211, 221, 231, 241, 251 =4 (Flush Valve)**

Relay Setpoint 1 is entered in Pump cycles to set Flush Interval.

See the appropriate relay Function tables (**P211, 221, 231, 241, 251**) for further information.

**P211, 221, 231, 241, 251 =5 (Step Time)**

Relay Setpoint 1 is entered in values of Measurement Units (P104)

See the appropriate relay function tables (**P211, 221, 231, 241, 251**) for further information.

**P211, 221, 231, 241, 251 =6 (Differential)**

Relay Setpoint 1 is entered in values of Measurement Units (P104)

See the appropriate relay function tables (**P211, 221, 231, 241, 251**) for further information.

*P214, P224, P234, P244, P254 Relay Setpoint 2***P211, 221, 231, 241, 251 =1 (Time)**

This parameter determines the "Cycle Time" for the operation of the relay. See the appropriate relay Function tables (**P211, 221, 231, 241, 251**) for further information.

**P211, 221, 231, 241, 251 =2 (Storm)**

Relay Setpoints are entered in values of Measurement Units (P104) See the appropriate relay Function tables (**P211, 221, 231, 241, 251**) for further information.

**P211, 221, 231, 241, 251 =3 (Aeration)**

Relay Setpoints are entered in Minutes to set Time Period that the relay will remain ON.

See the appropriate relay Function tables (**P211, 221, 231, 241, 251**) for further information.

**P211, 221, 231, 241, 251 =4 (Flush Valve)**

Relay Setpoints are entered in cycles to set the number of Flush cycles.

See the appropriate relay Function tables (**P211, 221, 231, 241, 251**) for further information.

**P211, 221, 231, 241, 251 =5 (Step Time)**

Relay Setpoints are entered in Seconds to set Drive Period, the time that the relay will remain ON

See the appropriate relay Function tables (**P211, 221, 231, 241, 251**) for further information.

**P211, 221, 231, 241, 251 =6 (Differential)**

Relay Setpoints are entered in values of Measurement Units (P104)

See the appropriate relay Function tables (**P211, 221, 231, 241, 251**) for further information.

*P215, P225, P235, P245, P255 Relay Setpoint 3*

**P211, 221, 231, 241, 251 = 4 (Flush Valve)**

Enter desired Flush duration in seconds.

See the appropriate relay Function tables (**P211, 221, 231, 241, 251**) for further information.

**P211, 221, 231, 241, 251 = 5 (Step Time)**

This parameter is used to determine the Limit Time between each Drive Period. Relay Setpoints are entered in Minutes, during which time the relay will remain OFF.

See the appropriate relay Function tables (**P211, 221, 231, 241, 251**) for further information.

**When Ultra Wizard = 3 Flow**

*P213, P223, P233, P243, P253 Relay Setpoint 1*

**P211, 221, 231, 241, 251 =2 (Step Time)**

Relay Setpoint 1 is entered in values of Measurement Units (P104)

See the appropriate relay function tables (**P211, 221, 231, 241, 251**) for further information.

*P214, P224, P234, P244, P254 Relay Setpoint 2*

**P211, 221, 231, 241, 251 =2 (Step Time)**

Relay Setpoints are entered in Seconds to set Drive Period, the time that the relay will remain ON

See the appropriate relay Function tables (**P211, 221, 231, 241, 251**) for further information.

*P215, P225, P235, P245, P255 Relay Setpoint 3*

**P211, 221, 231, 241, 251 = 2 (Step Time)**

This parameter is used to determine the Limit Time between each Drive Period. Relay Setpoints are entered in Minutes, during which time the relay will remain OFF.

See the appropriate relay Function tables (**P211, 221, 231, 241, 251**) for further information.



### Miscellaneous

#### P210, 220, 230, 240, 250 = 4 (Miscellaneous)

When a relay is set to be a **miscellaneous relay**, the **second parameter** determines its **function**.

#### P211, 221, 231, 241, 251 – Relay Function

This function allows the relay to work in relation to a clock or a specific event and will be set to activate in relation to Real Time.

OPTIONS	DESCRIPTION
<b>0 = Off (Default)</b>	Relay is always de-energised
1 = Clock	Relay will <b>energise ON</b> at a specified time each day as set in Relay Setpoint 1 (P213, 223, 233, 243, 253). And turns <b>OFF, de-energises</b> , after the specified-On Time period as set in Relay Setpoint 2 (P214, 224, 234, 244, 254)
<b>When Ultra Wizard = 2 Pump/Differential And Pump Volume Enabled (P205) = 1 or When Ultra Wizard = 3 Flow</b>	
2 = Totaliser	Relay will energise ON momentarily each time the specified flow has passed as set in Relay setpoint 1 (P213, 223, 233, 243, 253), this parameter sets the multiplication factor which will be applied to the on board totaliser (P820) to determine the switch point of the relay. E.g. if the totaliser is set to totalise in cubic metres and the relay is required to provide a closure every 10,000 litres Relay setpoint 1 would be set to 10. Relay setpoint 2 (P214, 224, 234, 244, 254) can be used to select the time the relay will remain closed in seconds.

#### Important Notice

When using a Relay to control a device at a specified time of day ensure that the Time P932 is set correctly. And if required, enable Daylight Saving for the appropriate time difference P970 – P979.

The **third parameter** has **no function** when **miscellaneous relay** is chosen and will not be displayed.

The **fourth parameter**, and **fifth parameter**, are set to determine the switch points, "ON" and "OFF" for the relay. See **miscellaneous** function table (**P211, 221, 231**) for further information.

**P210, 220, 230, 240, 250 = 1 (Clock)**

*P213, 223, 233, 243, 253 – Relay Setpoint 1*

Relay Setpoints are entered in Hours & Minutes (HH:MM) to set Time at which relay will energise. Default = **00:00 (HH:MM)**

*P214, 224, 234, 244, 254 – Relay Setpoint 2*

Relay Setpoints are entered in seconds to set the **Time Period** that the relay will remain 'ON'. **Default = 0.00 mins.**

**P210, 220, 230= 2 (Totaliser)**

*P213, 223, 233, 243, 253 – Relay Setpoint 1*

Relay Setpoints are entered as a factor by which the on-board totaliser (P820) should be multiplied by to provide a relay closure. **Default = 0.00**

*P214, 224, 234, 244, 254 – Relay Setpoint 2*

Relay Setpoints are entered in seconds to set the **Time Period** that the relay will remain 'ON'. **Default = 0.00 secs.**

## Pump by Time

### When Ultra Wizard = 2 Pump/Differential

When a relay is assigned to Pump by Time the pump will come on (energise) at its normal **"ON" level** setpoint, and de-energise at its **OFF level** setpoint or after a predetermined **time** period, **whichever occurs first**.

### P210, 220, 230, 240, 250 = 5 (Pump by Time)

When a relay is being used for a **pump by time** function, the **second parameter** determines the **pump duty** that will be used to determine the operating cycle.

### P211, P221, P231, P241, P251 - Relay Function,

This parameter defines which **pump duty** the relay should respond to as follows.

PUMP DUTY	DESCRIPTION
<b>0 = Off (Default)</b>	Relay is always de-energised
1 = Fixed duty assist	All pumps are used to assist each other (run at the same time) and each pump has its own setpoints. (P213, 223, 233, 243, 253 & P214, 224, 234, 244, 254).
2 = Fixed duty backup	If a pump fails to meet the demand (due to malfunction, intake blockage etc.), then it is stopped, and another pump shall take over. Each pump has its own setpoints. (P213, 223, 233, 243, 253 & P214, 224, 234, 244, 254).
3 = Alternate duty assist	All pumps are used to assist each other (run at the same time) and each pump has its own setpoints, (P213, 223, 233, 243, 253 & P214, 224, 234, 244, 254). but each time all pumps have stopped, then the setpoints are sequentially rotated between the pumps to ensure equal pump use.

PUMP DUTY	DESCRIPTION
4= Alternate duty backup	If a pump fails to meet the demand (due to malfunction, intake blockage etc.), then it is stopped, and another pump shall take over. Each pump has its own setpoints, (P213, 223, 233, 243, 253 & P214, 224, 234, 244, 254) but each time all pumps have stopped, then the setpoints are sequentially rotated between the pumps to ensure equal pump use.
5= Duty backup and assist	First pump comes on, if it cannot cope, it goes off and next pump comes on (duty backup). This continues until the last pump comes on and if it cannot cope the first pump comes back on to assist the last pump (duty assist) if the level continues to rise all other pumps will come on (assist) in turn until the level decreases to the pump off points. Each pump has its own setpoints, (P213, 223, 233, 243, 253 & P214, 224, 234, 244, 254).

**Important Notice**

The pumps are started and stopped at the "ON" and "OFF" setpoints. To *pump down* (reduce level) then set "ON" higher than "OFF". To *pump up* (increase level) then set "ON" lower than "OFF".

The **third parameter** for each relay determines the pump group. You can have two groups of pumps, and all similar duties within that group will operate together.

**P212, P222, P232, P242, P252 - Relay Pump Group**

By **default**, all pump groups are set to **1**, but if you want to have another group, then set this parameter to 2, for each pump relay that should operate together as part of a second group.

The **fourth parameter**, and the **fifth parameter** for each relay set the **pump "ON"** and **"OFF"** points, which are entered in **Measurement units P104**. For **pump down** the **"ON"** is set **higher than "OFF"**. For **pump up** then **"ON"** is set **lower than "OFF"**. See the appropriate **pump duty**, function table (**P212, 222, 232, 242, 252**) for further information.

*P213, P223, P233, P243, P253 - Relay Setpoint 1*

This parameter determines the **"ON"** point of the pump.

*P214, P224, P234, P244, P254 - Relay Setpoint 2*

This parameter determines the **"OFF"** point for the pump.

When a relay is being used for a **pump by time** function, then the **sixth parameter** will determine the maximum time the pump will be allowed to run before it is switched off and the next pump takes over.

*P215, P225, P235, P245, P255 - Relay Setpoint 3*

This parameter determines the **Maximum Time** the pump will be allowed to **run** before being switched **"OFF"** and is entered in minutes.

The pump will switch off either at its **"OFF"** level **Relay Setpoint 2 (P214, 224, 234, 244, 254)** or its **Maximum Run Time Relay Setpoint 3 (P215, 225, 235, 245, 255)**, whichever occurs **first**.

*P219, P229, P239, P249, P259 - Relay Max.Rate*

This parameter will allow a **pump** or **general control relay** to be **switched** at a pre-determined **Rate of change of Level**, irrespective of the **"ON"** level setpoint P213, 223, 233, 243, 253. Once a pump or general control relay has been switched **"ON"** by the pre-determined **Rate of Change**, it will remain energised until the level reaches the **"OFF"** level setpoint **P214, 224, 234, 244, 254**.

Max. Rate is entered in Measurement Units (P104) per minute and can be entered as either positive (increasing level) or negative (decreasing level) values.

**Common Relay parameters**

*P216, 226, 236, 246, 256 – Relay Allocation*

This parameter determines which input the relay will act on. You can set it to the transducer (default), or the optional auxiliary (current) input, or an average of the two. In most cases, this will not need to be changed from the default.

OPTIONS	DESCRIPTION
<b>1 = Xducer 1 (Default)</b>	Relay acts on Xducer 1 calculated values
2 = Xducer 2	Relay acts on Xducer 2 calculated values
3 = Auxiliary (Optional)	Relay acts on optional current input levels
<b>When Ultra Wizard = 1 Level/Volume or 2 Pump/Differential</b>	
4 = Average of 1 & 2	Relay acts on the resulting average levels of two signal inputs.
<b>When Ultra Wizard = 2 Pump/Differential</b>	
5 = Differential of 1 & 2	Relay acts on the resulting differential level of two signal inputs

*P217, P227, P 237, P247, P257 - Relay Closures*

The Ultra 5 will record how many times each relay is closed, this parameter displays the number of times the relay has activated since the relay has been in use. It can be reset with any value.

*P218, P228, P238, P248, P258 - Relay Fail Safe*

Your Ultra 5 has a general fail-safe parameter P808. However, this can be overridden so that each individual relay has its own independent failsafe mode.

This parameter determines what the relay will do in the event of the Failsafe Time (P809) expiring.

OPTIONS	DESCRIPTION
<b>0 = Default</b>	Relay assumes system default mode P808
1 = Hold	Relay remains in its current state
2 = De-energise	Relay will De-energise
3 = Energise	Relay will energise

## ***Pump "Advanced" Parameters***

### **When Ultra Wizard = 2 Pump/Differential**

The following parameters are used to set the "Advanced" Pump features.

#### ***Pump Run On***

This feature is used to periodically allow the pumps to continue operating below their normal "OFF" point, to discharge any sediment that may have settled at the bottom of the vessel.

#### ***P349 Prime Level***

Sets the required level to ensure pumps are fully primed after a pump run on has occurred. Following a pump run on, any pump, whose "ON" point is below the Prime Level will be held "OFF" until the Prime Level has been exceeded.

#### ***P350 Run Interval***

Set required time period, in hours, at which pump run on should occur.

#### ***P351 Run Duration***

This parameter sets the length of time, in seconds, that pumps will run on for, it should be noted that only one run on is allowed per Run Interval.

#### ***Starting***

This feature is used to reduce the effects of power surges, caused by switching of pumps, in the following instances, (**P352**) **Power surge** (mains or hydraulic) that is generated when multiple pumps are started simultaneously, (**P353**) **Power resumption** following a power failure.

#### ***P352 Start Delay***

Set the required time period, in seconds, that should elapse between pumps starting. **Default = 10 seconds.**

#### ***P353 Power Delay***

Set the required time period, in seconds, that should elapse before pumps are allowed to start following a power failure. **Default = 10 seconds.**

**Stopping**

If required, this feature will **prevent** pumps, with a **common “OFF” point** being switched off all at the same time pumps will be switched **“OFF”** in turn as determined by the **delay** set in **P348 Stop Delay**.

*P348 Stop Delay*

Set the required time period, in seconds, that should elapse between pumps stopping. **Default = 0.0 seconds.**

**Pump Exercising**

This feature is used to reduce idle pump corrosion and sediment build up. Pumps can run after a specified **Idle Time (P355)** for a determined period of **Exercise time (P356)**, providing a **Minimum head /level (P357)** is present and all other pumps are switched off.

*P354 Exercise Enable*

This parameter determines if Pump Exercising is enabled or disabled.

OPTIONS	DESCRIPTION
0 = No (Default)	Pump exercising disabled
1 = Yes	Pump exercising enabled

*P355 Idle Time*

Sets the Idle Time to elapse before Pump Exercising is to be activated. Set the required time period in minutes. **Default = 720 minutes.**

*P356 Exercise Time*

Set the required Exercise Time in seconds. **Default = 30 seconds**

*P357 Minimum Head*

To prevent the dry running and the possibility of cavitation, of the pump, enter the minimum level (head) of material, in metres, that is to be present before permitting pump exercising to take place.



### Wall Cling

To reduce material build up, (such as fat), on the wall of the sump or vessel, at the “normal” material level the pump setpoints can be varied within a specified band.

For Pump Down applications the relay setpoints for the pumps will be randomly varied within the band specified, somewhere below ON, but to a maximum of the setting, and somewhere higher than OFF, but to a maximum of the setting.

For Pump Up applications the relay setpoints for the pumps will be randomly varied within the band specified somewhere higher than ON, but to a maximum of the setting, and somewhere lower than OFF, but to a maximum of the setting.

#### *P360 Wall Cling*

Enter the maximum band, of variation, required in **measurement units P104**.

### Storm

This facility enables all pumps to be **disabled (P370)** during a storm condition to prevent the futile running or potential damage due to the continued use of pumps during flood conditions. Provision is also made to allow a maximum **time period (P371)** for which pumps will remain disabled during such conditions. For this function to operate a relay must have been assigned to Storm and have Upper and Lower storm setpoints set. See **P210, 220, 230, 240, 250 = 3 (Control) P211, 221, 231, 241, 251, Relay Function =2 (Storm)** for further details.

#### *P370 Pump Disable*

This parameter sets the action required during a flood condition.

OPTIONS	DESCRIPTION
0 = Disabled	Pumps disabled during storm condition.
1 = <b>Normal (Default)</b>	Normal pump operation during storm condition

#### *P371 Disable Time*

This parameter will set the maximum time pumps will remain disabled if P370 = 0 Enter desired time in minutes. **Default = 30 minutes**



## Data Log parameters

The data log parameters contain the following information:

### Totaliser Audits

**When Ultra Wizard = 2 Pump/Differential  
and  
Pump Volume enabled (P205) = 1  
or  
When Ultra Wizard = 3**

#### *P460 to P479 Total Audits*

When Pump Volume is enabled, parameters **P460-P479** show the **date** and pumped **volume** total for the last **ten days**, the first on the list are the most recent and last ones are the oldest. When all ten total audits are full the oldest is pushed out and all totals increment through to allow the new days total to be registered in the first day's total audit parameter allocation.

#### *P480 Clear Logs*

This parameter enables **all** the Total Audits (P460 – P479) to be cleared to factory default values.

### Important Notice

To ensure the accuracy of Flow during a 24-hour period, ensure that the **Time P932** is set correctly. And if required, enable **Daylight Saving** for the appropriate time difference **P970 – P979**.

## Temperature

The following parameters give information on temperature conditions seen by the **Temperature source (P852)** in °C. All these parameters are read only and cannot be changed, though if P852 is changed they will be reset.

#### *P580 Minimum Temperature*

This parameter displays the minimum temperature recorded.

#### *P581 Minimum Temperature Date*

This parameter displays the date when the minimum temperature was recorded.

*P582 Minimum Temperature Time*

This parameter displays the time when the minimum temperature was recorded.

*P583 Maximum Temperature*

This parameter displays the maximum temperature recorded.

*P584 Maximum Temperature Date*

This parameter displays the date when the maximum temperature was recorded.

*P585 Maximum Temperature Time*

This parameter displays the time when the maximum temperature was recorded.

*P586 Current Temperature*

This parameter displays the current temperature.

**Pump Logs**

**When Ultra Wizard = 2 Pump/Differential**

*P510 Pump 1 Hours*

This parameter displays the current total running hours for Pump 1. Any value from 0 - 9999 can be entered to facilitate any update to the stored total for any reason e.g. a replacement pump being fitted.

*P511 Pump 1 Starts*

This parameter displays the current total pump starts for Pump 1. Any value from 0 - 9999 can be entered to facilitate any update to the stored total for any reason e.g. a replacement pump being fitted.

*P512 Pump 1 Starts/Hour*

This parameter displays the current pump Starts/Hour for Pump 1. Any value from 0 - 9999 can be entered to facilitate any update to the stored total for any reason e.g. a replacement pump being fitted.

*P513 Pump 1 Run On*

This parameter displays the current number of Pump Run On's, which have occurred, for Pump 1. Any value from 0 - 9999 can be entered to facilitate any update to the stored total for any reason e.g. a replacement pump being fitted.

*P514 Pump 1 Draw*

This parameter displays the current Draw Rate for Pump 1, which is used to calculate the pump efficiency. Any value from 0 - 9999 can be entered to facilitate any update to the stored total for any reason e.g. a replacement pump being fitted.

*P515 Pump 1 Efficiency*

This parameter displays the current value for Pump 1 Efficiency, which is used to calculate the pump efficiency and will update with any change to the **Pump Draw Rate (P514)**.

*P516 - P521 Pump 2*

These parameters contain the same information as above for Pump 2.

*P522 - P527 Pump 3*

These parameters contain the same information as above for Pump 3.

*P528 - P533 Pump 4*

These parameters contain the same information as above for Pump 4.

*P534 - P539 Pump 5*

These parameters contain the same information as above for Pump 5.

***Pumped Volume*****When Ultra Wizard = 2 Pump/Differential***Set Up**P205 Pump Vol. Enable*

This parameter determines if Pumped Volume is in use or not.

OPTIONS	DESCRIPTION
<b>0 = Off (Default)</b>	Pumped volume calculation is switched <b>Off</b>
1 = On	Pumped volume calculation is switched <b>On</b>

*P206 Settle Time*

This parameter determines the time allowed for the level to settle after all pumps have switched Off, to avoid any effects of flow back or turbulence, before calculating the Inflow Rate. Enter desired time in minutes. **Default = 1 minute**

*P207 Inflow Method*

This parameter determines which method is used to calculate the inflow of material during a pump down cycle.

OPTIONS	DESCRIPTION
0 = No Inflow	Inflow during pumping is not calculated
<b>1 = Average Inflow (Default)</b>	Average between Inflow at time pump started and Inflow after Settle Time used to calculate Inflow during pumping.

## Volume

### When Ultra Wizard = 1 Level/Volume or 2 Pump/Differential

Your Ultra 5 provides a variety of volume calculation features, **with 11** pre-programmed **vessel shapes**. See **Vessel Shape (P600)** for more information. For each vessel you will need to know the **dimensions (P601-603)** in **Measurement Units (P104)** which are required to calculate the **volume (P604)** which will be displayed in the selected **Volume Units (P605)**.



If your vessel shape does not correspond with any of the pre-programmed vessel shapes, then you can use the **universal calculations**. For this you will need a level/volume graph or chart provided by the vessel manufacturer or you can create one based on the dimensions of the vessel. You can enter up to 32 pairs of breakpoints, and the more you enter, the greater accuracy of the volume calculation will be.

## Conversion

### P600 Vessel Shape

This parameter determines which vessel shape is used when utilising "Volume Conversion".

The choices are as shown in the table below, along with the **dimensions** that are required to be entered (**P601-P603**).

VESSEL SHAPE	P600 VALUE DESCRIPTION	DIMENSIONS
	P600 = 0 ( <b>Default</b> ) Cylindrical Flat Base	Cylinder diameter
	P600 = 1 Rectangular Flat Base	Width and Breadth

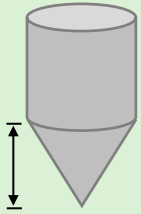
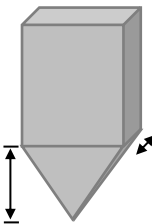
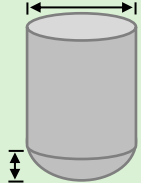
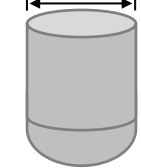
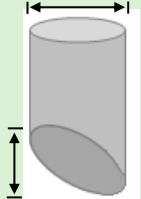
VESSEL SHAPE	P600 VALUE DESCRIPTION	DIMENSIONS
	<p>P600 = 2 Cylindrical Cone Base</p>	<p>Cylinder diameter and height of bottom</p>
	<p>P600 = 1 Rectangular Flat Base</p>	<p>Width and Breadth</p>
	<p>P600 = 4 Parabola Base</p>	<p>Cylinder diameter and height of bottom</p>
	<p>P600 = 5 Flat Sloped Base</p>	<p>Cylinder diameter</p>
	<p>P600 = Flat Sloped Base</p>	<p>Cylinder diameter and height of bottom</p>



VESSEL SHAPE	P600 VALUE DESCRIPTION	DIMENSIONS
	P600 = 7 Rectangular flat sloped base	Width and breadth of rectangular section and height of bottom
	P600 = 8 Horizontal cylinder with flat ends	Cylinder diameter and tank length
	P600 = 9 Horizontal cylinder with parabolic ends	Cylinder diameter, length of one end and section, and tank length
	P600 = 10 Sphere	Sphere diameter
	P600 = 11 Universal linear	No dimensions required as level, and volume breakpoints are used
	P600 = 12 Universal curved	No dimensions required as level, and volume breakpoints are used

*P601-P603 Vessel Dimensions*

These three parameters are used to enter the dimension required to calculate the volume. The dimensions required are as shown below and are entered **Measurements Units (P104)**.

<b>VESSEL SHAPE</b>	<b>P601</b>	<b>P602</b>	<b>P603</b>
P600 = 0 Cylindrical flat base	Cylinder Diameter	Not required	Not required
P600 = 1 Rectangular flat base	Not required	Width of rectangle	Breadth of rectangle
P600 = 2 Cylindrical cone base	Height of base	Width of rectangle	Not required
P600 = 3 Rectangular pyramid base	Height of base	Width of rectangle	Breadth of rectangle
P600 = 4 Cylindrical parabola base	Height of base	Cylinder diameter	Not required
P600 = 5 Cylindrical half sphere base	Cylinder diameter	Not required	Not required
P600 = 6 Cylindrical flat sloped base	Height of base	Cylinder diameter	Not required
P600 = 7 Rectangular flat sloped base	Height of base	Width of rectangle	Breadth of rectangle
P600 = 8 Horizontal cylinder flat ends	Length of cylinder	Cylinder diameter	Not required
P600 = 9 Horizontal cylinder parabolic ends	Length of cylinder	Cylinder diameter	Length of one end
P600 = 10 Sphere	Sphere diameter	Not required	Not required

*P604 Calculated Volume*

This parameter displays the maximum volume that has been calculated by the Ultra 5 and is a Read Only parameter. The volume displayed will be shown in cubic meters and is the total volume available between **empty level (P105)** and 100% of **span (P106)**.

### *P605 Volume Units*

This parameter determines the units that you wish to display, for volume conversion. It is used in conjunction with **P607 (maximum volume)**, and the units are shown on the display (subject to P810). The choices are:

OPTION	DESCRIPTION
0 = No units	Volume will be totalised with <b>no units</b>
1 = Tons	Volume will be totalised in <b>Tons</b>
2 = Tonnes	Volume will be totalised in <b>Tonnes</b>
<b>3 = Cubic metres (Default)</b>	Volume will be totalised in <b>Cubic metres</b>
4 = Litres	Volume will be totalised in <b>Litres</b>
5 = UK Gallons	Volume will be totalised in <b>UK Gallons</b>
6 = US Gallons	Volume will be totalised in <b>US Gallons</b>
7 = Cubic Feet	Volume will be totalised in <b>Cubic Feet</b>
8 = Barrels	Volume will be totalised in <b>Barrels</b>
9 = lbs (pounds)	Volume will be totalised in <b>lbs (pounds)</b>

### *P606 Correction Factor*

This parameter is used to enter a correction factor, when required, such as the specific gravity of the material so that the volume calculated is relative to the actual amount of material that can be contained between **empty level (P105)** and 100% of **span (P106)**. **Default = 1**

### *P607 Max Volume*

This parameter displays the actual maximum volume that has been calculated by the Ultra 5, i.e. **P604 Calculated Volume x P606 Correction Factor**, and is a Read Only parameter. The volume displayed will be shown in **P605 Volume Units** and is the total volume available between **empty level (P105)** and 100% of **span (P106)**.

### Breakpoints

#### *P610-P673 Level/Volume Breakpoints*

These parameters are used to create a profile of the vessel when **P600=11 (universal linear)** or **P600=12 (universal curved)**. You should enter breakpoints in pairs, a reading for level and its corresponding volume. The more pairs you enter, the more accurate the profile will be. In the case of universal linear, then enter the level/volume at each of the points where the vessel changes shape. In the case of the universal curved, enter values around each arc tangent, as well as at the top and bottom.

You must enter at least two pairs, and you can enter up to 32 pairs.

#### *Universal Linear (P600=11)*

This volume calculation creates a linear approximation of the level/volume relationship and works best if the vessel has sharp angles between each section.

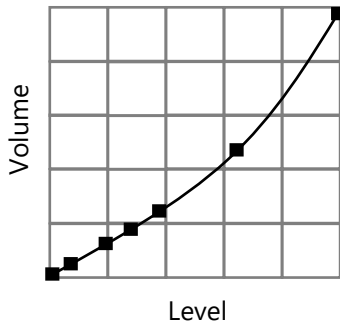

You should enter a level/volume breakpoint for each place where the vessel changes direction, and numerous where the section is slightly curved (mostly linear but has got a small arc). You can enter any number of pairs between 2 and 32.

### *Universal Curved (P600=12)*

This volume calculation creates a curved approximation of the level/volume relationship, and works best if the vessel is non-linear, and there are no sharp angles.

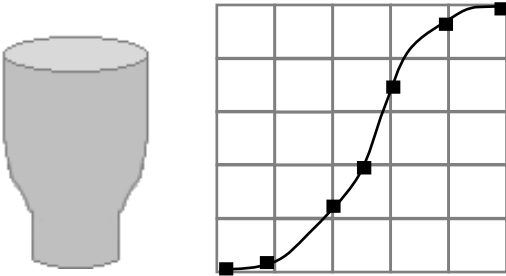

You should enter 2 level/volume breakpoints at the minimum and maximum levels, and several for each place where the vessel has got an arc. You can enter any number of pairs between 2 and 32.

### **Tables**

#### *P696 Reset Breakpoints*

This parameter allows the resetting, to the default value, of all previously set breakpoints (P610-673), without having to access them individually. When it is necessary to reset or amend breakpoints this can be achieved by directly accessing the desired parameter (P610-673) and changing as required.

#### *P697 Number of Breakpoints Set*

This parameter allows you to review the number of breakpoints that have been set, without the need to access each individual one in turn, this is a "Read Only" parameter and no values can be entered.

## Pump Efficiency

### When Ultra Wizard = 2 Pump/Differential

#### Set Up

#### P187 Pump Efficiency

This parameter determines whether pump efficiency is enabled or disabled.

OPTIONS	DESCRIPTION
0 = Off (Default)	Pump efficiency is <b>disabled</b>
1 = On	Pump efficiency is <b>enabled</b>

#### P188 Calib. Delay

This parameter is used to set a delay, after all pumps have stopped, to allow for any turbulence of the material surface to settle prior to monitoring the level in the vessel and determining the inflow before the next pump cycle commences. The delay time is entered in seconds. **Default = 45 seconds.**

#### Important Notice

When setting the **time period** for the **Calibration Delay** (P188) it is important that it does not **exceed** the **time from** when all pumps switch **Off** to the first pump **Start** during **normal operation** as it will prevent **determining** the **Inflow** and any subsequent **calculation of Efficiency**.

#### P189 Cal. Duration

This parameter sets the time duration over which the pumps performance will be monitored, and the resulting efficiency is calculated.

#### Important Notice

When setting the **time period** for the **Calibration Duration** (P189) it is important that it does not **exceed** the **time from** one pump **Start** to the next pump **Start** during **normal operation** as it will abort any subsequent **calculation of Efficiency**.

#### P190 Persist Cnt.

If an alarm is to be used to indicate when the Pump efficiency falls below a predetermined level, this parameter determines the number of consecutive times the pump will be allowed to run, at the reduced efficiency, before the alarm will be activated. The Persist Count can be set to Min. 0, Max 99.

**Default = 6**

*P191 Demote Pumps.*

When an efficiency alarm is being used, this parameter will determine if a pump is to be demoted to the last pump in the duty cycle on activation of the alarm. When Demote Pump is enabled and the efficiency alarm is activated after the predetermined Persist Count (P190) the pump duty will default to a fixed duty regime with the inefficient pump being set to the last pump in the cycle which will be called to start if the level reaches the on point for that pump. A pump which has been demoted will be indicated by the relevant "pump" relay LED "flashing" RED.

OPTIONS	DESCRIPTION
<b>0 = Off (Default)</b>	Demote pump is <b>disabled</b>
1 = On	Demote pump is <b>enabled</b>

*P192 Demote Flags*

This parameter will indicate, in a binary number format as detailed below, which pumps, if any, have been demoted. Any demoted pump(s) can be reset by entering "0".

0 = None	16 = Pump 5
1 = Pump 1	17 = Pump 1 + 5
2 = Pump 2	18 = Pump 2 + 5
3 = Pump 1 + 2	19 = Pump 1 + 2 + 5
4 = Pump 3	20 = Pump 3 + 5
5 = Pump 1 + 3	21 = Pump 1 + 3 + 5
6 = Pump 2 + 3	22 = Pump 2 + 3 + 5
7 = Pump 1 + 2 + 3	23 = Pump 1 + 2 + 3 + 5
8 = Pump 4	24 = Pump 4 + 5
9 = Pump 1 + 4	25 = Pump 1 + 4 + 5
10 = Pump 2 + 4	26 = Pump 2 + 4 + 5
11 = Pump 1 + 2 + 4	27 = Pump 1 + 2 + 4 + 5
12 = Pump 3 + 4	28 = Pump 3 + 4 + 5
13 = Pump 1 + 3 + 4	29 = Pump 1 + 3 + 4 + 5
14 = Pump 2 + 3 + 4	30 = Pump 2 + 3 + 4 + 5
15 = Pump 1 + 2 + 3 + 4	31 = Pump 1 + 2 + 3 + 4 + 5

*P193 Calib. Pumps*

This parameter is used to calibrate the pumps and determine the optimum (100%) efficiency of the pump from which all subsequent efficiency calculations will be derived. You can either choose to "calibrate" an individual pump or alternatively have each pump "calibrated" in turn automatically. When selecting pumps to be calibrated individually (Option 1 to 5), it is essential that the level in the vessel is above the relevant pump start point to ensure correct calibration. Once you have selected the pump to be "calibrated" you will be prompted to return to the RUN mode, there will then be a delay before the pump starts which is equal to the **Calib.**

**Delay (P188)** the display will show the time being counted down time to the pump start. Once the pump has started the display will show a countdown time equal to the **Cal. Duration (P189)**, calculation of pump efficiency will be completed on the expiry of the count and the unit will return to normal operation. If you choose to "calibrate" the pumps automatically (Option 7) then when the unit is returned to the RUN mode each pump will be "calibrated" in turn as and when it is next called to run.



## OCM Parameters

### When Ultra Wizard = 3 Flow

#### *PMD Setup*

#### *P700 Primary Measuring Device Type*

This parameter is used to select the **type of Primary Measuring Device** and enable additional parameters required to calculate the flow of the Primary Measuring Device chosen (P701). Options are as follows:

#### **0 = Off (Default)**

- 1 = Exponent
- 2 = BS3680 Flume
- 3 = BS3680 Weir
- 4 = Area/Velocity (Optional)
- 5 = Special
- 6 = Universal

#### *P701 Primary Measuring Device*

Enter the Primary Measuring Device used.

#### **If P700 = 1 (Exponent)**

Select from the following options:

- 1 = Suppressed Rectangular Weir
- 2 = Cipolletti (Trapezoidal) Weir
- 3 = Venturi Flume
- 4 = Parshall Flume
- 5 = Leopold Lagco Flume
- 6 = V- notch Weir
- 7 = Others
- 8 = Rectangular Weir with End Contractions

**If P700 = 2 (BS 3680 Flume)**

Select from the following options:

- 1 = Rectangular
- 2 = Rectangular with hump
- 3 = U-throated
- 4 = U-Throated with hump

**If P700 = 3 (BS 3680 Weir)**

Select from the following options:

- 1 = Rectangular
- 2 = V-Notch 90-degree (full 90°)
- 3 = V-Notch 53 degree 8' (half 90°)
- 4 = V-Notch 28 degree 4' (quarter 90°)
- 5 = Broad crested (Rectangular) Weir

**If P700 = 4 (Area Velocity) Optional**

The calculation of flow using Velocity Area is only possible when the optional current input is available to provide an input from a velocity sensing device which provides a signal proportional to flow. (Please consult Pulsar for availability).

Select from the following options:

- 1 = Circular Straight (U-Channel), circular bottom, straight sides.
- 2 = Rectangular
- 3 = Trapezoidal
- 4 = Round Pipe

**If P700 = 5 (Special)**

Select from the following options:

- 1 = Palmer-Bowlus Flume
- 2 = H-Flume
- 3 = V-Notch angle (other than BS3680)

### If P700 = 6 (Universal)

Where the Primary Measuring device does not match any of the devices contained in the above categories then a universal volume calculation can be performed. A head Vs flow chart is used, to enter several **Breakpoints** for head and flowrate (**P730-793**), which is either provided by the manufacturer or created based on the dimensions of the device.

Select from the following options:

1 = Universal Linear flow calculation

2 = Universal Curved flow calculation

#### *P702 Calculation*

Select the required **calculation method**, both will give similar answers, the difference being the information required to complete the calculation. For ratiometric it is normally sufficient to know the maximum flow at the maximum head. Choose between:

1 = Absolute

**2 = Ratiometric (Default)**

#### *P703 Minimum Head*

This parameter is used to enter the **distance**, above empty, that represents **zero head** and **flow**. This feature is used in Primary Measuring Devices where the zero reference is at a higher level than the channel bottom, at the point of measure. Enter distance in **Measurement Units P104**.

#### *P704 Maximum Head*

Enter the **head** value that represents **maximum flow**, enter in **Measurement Units P104**.

Note any change to the value of this parameter will be reflected in P106 (Span) and vice versa.

*P705 Maximum Flow*

When **P702 = 2 Ratiometric** enter the **flow rate** value that occurs at **maximum head (P704)**, enter in **volume units (P706)** per **time units (P707)**.

When **P702 = 1 Absolute**, and all relevant flow parameters have been entered, the **maximum flow** that occurs at **maximum head P704** will be calculated, after the unit is returned to RUN mode, and displayed in this parameter in **volume units (P706)** per **time units (P707)**.

*P706 Volume Units*

Select the Volume Units to be used to display and calculate the flow rate from the options below:

OPTION	DESCRIPTION
<b>1 = Litres (Default)</b>	Flow units will be calculated and displayed in <b>Litres</b>
2 = Cubic metres	Flow units will be calculated and displayed in <b>m<sup>3</sup></b>
3 = Cubic feet	Flow units will be calculated and displayed in <b>Ft<sup>3</sup></b>
4 = UK Gallons	Flow units will be calculated and displayed in <b>UK Galls</b>
5 = US Gallons	Flow units will be calculated and displayed in <b>US Galls</b>
6 = Mil. USG	Flow units will be calculated and displayed in <b>Millions of US Galls</b>

*P707 Time Units*

Select the Time Units to be used with the Volume Units to determine the desired flow rate from the options below:

OPTION	DESCRIPTION
<b>1 = per Second (Default)</b>	<b>Flowrate</b> will be calculated in and displayed in <b>volume units/second</b>
2 = per Minute	<b>Flowrate</b> will be calculated in and displayed in <b>volume units/minute</b>
3 = per Hour	<b>Flowrate</b> will be calculated in and displayed in <b>volume units/hour</b>
4 = per Day	<b>Flowrate</b> will be calculated in and displayed in <b>volume units/day</b>

### *P708 Flow Decimal*

This parameter determines the number of decimal places in the flow rate reading during run mode. It can be set between 1 and 3. **Default = 2**

### *P709 Flow Cut Off*

This parameter is used to select the minimum flow, in a % of flow rate, which is to be totalised. Enter values in % of maximum flow. **Default = 5%**

## **Dimensions**

### *P710 Dimension A*

This parameter is used to enter dimension "A" of the Primary Measuring Device, where applicable, **see table below for further details.**

### *P711 Dimension B*

This parameter is used to enter to enter dimension "B" of the Primary Measuring Device, where applicable, **see table below for further details.**

### *P712 Dimension C*

This parameter is used to enter to enter dimension "C" of the Primary Measuring Device, where applicable, **see table below for further details.**

### *P713 Dimension D*

This parameter is used to enter to enter dimension "D" of the Primary Measuring Device, where applicable, **see table below for further details.**

*Dimensions table*

<b>PRIMARY MEASURING DEVICE</b>	<b>P710 Dim 'A'</b>	<b>P711 Dim 'B'</b>	<b>P712 Dim 'C'</b>	<b>P713 DIM 'B'</b>
P700 = 1 Exponent P701 = 1 Supp. Rectangular Weir P702 = 1 Absolute	Crest Width	<i>Not Required</i>	<i>Not Required</i>	<i>Not Required</i>
P700 = 1 Exponent P701 = 2 Trapezoidal P702 = 1 Absolute	Crest Width	<i>Not Required</i>	<i>Not Required</i>	<i>Not Required</i>
P700 = 1 Exponent P701 = 5 Leopold Lagco Flume P702 = 1 Absolute	Throat Diameter	<i>Not Required</i>	<i>Not Required</i>	<i>Not Required</i>
P700 = 1 Exponent P701 = 6 V Notch P702 = 1 Absolute	V-Notch Angle	<i>Not Required</i>	<i>Not Required</i>	<i>Not Required</i>
P700 = 2 BS 3680 Flume P701 = 1 Rectangular	Approach Width	Throat Width	Throat Length	<i>Not Required</i>
P700 = 2 BS 3680 Flume P701 = 2 Rectangular with hump	Approach Width	Throat Width	Throat Length	Hump Height
P700 = 2 BS 3680 Flume P701 = 3 U-Throated	Approach Width	Throat Width	Throat Length	<i>Not Required</i>
P700 = 2 BS 3680 Flume P701 = 3 U-Throated with hump	Approach Width	Throat Width	Throat Length	Hump Height
P700 = 3 BS 3680 Weir P701 = 1 Rectangular	Approach Width	Crest Width	Crest Height	<i>Not Required</i>
P700 = 3 BS 3680 Weir P701 = 3 Rect. Broad crested	Approach Width	Crest Width	Crest Height	<i>Not Required</i>
P700 = 4 Area Velocity P701 = 1 Circular Straight	Base Diameter	<i>Not Required</i>	<i>Not Required</i>	<i>Not Required</i>
P700 = 4 Area Velocity P701 = 2 Rectangular	Channel Width	<i>Not Required</i>	<i>Not Required</i>	<i>Not Required</i>
P700 = 4 Area Velocity P701 = 3 Trapezoidal	Channel Width Top	Channel Width Bottom	Channel Depth	<i>Not Required</i>
P700 = 4 Area Velocity P701 = 4 Round Pipe	Inside Diameter	<i>Not Required</i>	<i>Not Required</i>	<i>Not Required</i>
P700 = 4 Area Velocity P701 = 5 Fixed Pipe	Inside Diameter	Fixed Head	<i>Not Required</i>	<i>Not Required</i>

<b>PRIMARY MEASURING DEVICE</b>	<b>P710 Dim 'A'</b>	<b>P711 Dim 'B'</b>	<b>P712 Dim 'C'</b>	<b>P713 DIM 'B'</b>
P700 = 5 Special	Flume	<i>Not</i>	<i>Not</i>	<i>Not</i>
P701 = 1 Palmer Bowlus	Size	<i>Required</i>	<i>Required</i>	<i>Required</i>
P700 = 5 Special	Flume	<i>Not</i>	<i>Not</i>	<i>Not</i>
P701 = 2 H-Flume	Size	<i>Required</i>	<i>Required</i>	<i>Required</i>
P700 = 5 Special	V-Notch	<i>Not</i>	<i>Not</i>	<i>Not</i>
P701 = 3 V-Notch Angle	Angle	<i>Required</i>	<i>Required</i>	<i>Required</i>

*P714 Roughness Coefficient (Ks)*

When P700 = 2, BS3680 Flume this parameter is used to enter the roughness coefficient of the flume in millimetres, **see table below for further details.**

Surface Classification	Value of Ks	
	Good Example mm	Normal Value mm
<b>Plastics</b> etc. Perspex, PVC or other smooth faced Asbestos cement Resin-bonded glass-fibre moulded against smooth forms of sheet metal or well sanded and painted timber	0.03	0.003 0.015 0.06
<b>Metal</b> Smooth, machined, and polished metal Uncoated sheet metal, rust free Painted metal Galvanised metal Painted or coated casting Uncoated casting	0.003 0.015 0.03 0.06 0.06 0.15	0.006 0.03 0.06 0.15 0.15 0.3
<b>Concrete</b> In-situ or precast construction using steel formwork, with all irregularities rubbed down or filled in. In-situ or precast construction using plywood or timber framework Smooth troweled cement rendering Concrete with thin film of sewage slime	0.06 0.3 0.3 0.6	0.15 0.6 0.6 1.5
<b>Wood</b> Planned timber or plywood Well sanded and painted	0.3 0.03	0.6 0.06

*P715 Water Temperature*

When P700 = 2, BS3680 Flume this parameter is used to enter the mean water temperature in °C.



*P717 Exponent*

This parameter is used to enter the exponent value when:  
 P700 PMD Type = 1 Exponent and P701 Primary M.D = 7 Others.

*P718 K Factor*

This parameter is used to enter the K Factor when:  
 P700 PMD Type = 1 Exponent and P702 Calculation = 1 Absolute **see table below for further details.**

PRIMARY MEASURING DEVICE (PMD)	P718 K FACTOR
P700 = 1 Exponent P701 = 1 Supp. Rectangular Weir	Automatically calculated
P700 = 1 Exponent P701 = 2 Trapezoidal Weir	Automatically calculated
P700 = 1 Exponent P701 = Venturi Flume	Obtain value and enter
P700 = 1 Exponent P701 = Parshall Flume	Automatically calculated
P700 = Exponent P701 = 5 Leopold Lagco Flume	Automatically calculated
P700 = 1 Exponent P701 = 6 V-Notch	Automatically calculated
P700 = 1 Exponent P701 = Other	Obtain value and enter

*P719 Throat Width*

This parameter is used to select the Throat Width of the flume when:  
 P700 PMD Type = 1 Exponent and P701 = 4 Parshall Flume. After selecting the Throat Width, the Exponent P717 and K Factor P 718 will be set automatically.

## Calculations

The following parameters P720 to P725 are values calculated by the unit, dependent on application, and are "Read Only", therefore have no default values.

### P720 Area

Displays the calculated value of the area when, P700 = 2 BS3690 flumes and P700 = 4 Area Velocity.

### P721 Cv

Displays the calculated value for Cv when, P700 = 2 BS3680 flumes.

### P722 Cd

Displays the calculated value for Cd when, P700 = 2 BS3680 flumes.

### P723 Ce

Displays the calculated value for Ce when, P700 = 2 BS3680 weirs.

### P724 Cu

Displays the calculated value for Cu when, P700 = 2 BS3680 flume and P701 = 3 or 4 U-Throated flumes.

### P725 Kb

Displays the calculated value for Kb when, P700 = 3 BS3680 weirs and P701 = 1 Rectangular weir.

## Velocity

The calculation of flow using Velocity Area is only possible when the optional current input is available to provide an input from a velocity sensing device which provides a signal proportional to flow. (Please consult Pulsar for availability).

Parameters P726 to P729 are used to configure the optional 4 -20mA input for a velocity sensing device. When an **Area/Velocity** application is selected the unit will automatically allocate the 4-20mA input to a velocity input device and it is therefore not necessary to allocate **P101 Transducer = 1** (Auxiliary).

### *P726 Low mA In*

This parameter sets the mA current input figure that is used to represent minimum velocity (P728) when the current input is allocated to a velocity input device. **Default = 4mA**

### *P727 High mA In*

This parameter sets the mA current input figure that is used to represent maximum velocity (P729) when the current input is allocated to a velocity input device. **Default – 20mA**

### *P728 Low Vel. In*

This parameter sets the minimum velocity, at low mA In (P726) when the current input is allocated to a velocity input device. **Default = 0m/sec.**

### *P729 High Vel. In*

This parameter sets the maximum velocity, at High mA In (P727) when the current input is allocated to a velocity input device. **Default = 1m/sec.**

## **Breakpoints**

### *P730-P793 Breakpoints*

Where the Primary Measuring device does not match any of the pre-programmed devices contained in the Flow 5, then a universal volume calculation can be performed. A head Vs flow chart is used, to enter several **Breakpoints** for the **head** and **flow (P730-793)**, which is either provided by the manufacturer or created based on the dimensions of the device.

Breakpoints should be entered in **pairs** of **head** and the corresponding **flow** for that head. The **first pair** entered must be for **zero head** and **flow** and the **last pair** entered must be for **maximum head** and **flow**. The higher number of breakpoints (pairs) entered then the greater accuracy there will be. There are a maximum number of 32 breakpoints (pairs) for head and flow that can be entered.

## **Tables**

### *P796 Reset Breakpoints*

This parameter allows the resetting, to the default value, of all previously set breakpoints (P730-793), without having to access them individually. When it is necessary to reset or amend breakpoints this can be achieved by directly accessing the desired parameter (P730-793) and changing as required.

### *P797 Number of Breakpoints Set*

This parameter allows you to review the number of breakpoints that have been set, without the need to access each individual one in turn, this is a "Read Only" parameter and no values can be entered.

## **Average Flow**

### *P863 Average Flow*

This parameter will display the Average Flow for the time period set in **Average Time (P864)**. It is read only and cannot be changed.

### *P864 Average Time*

This parameter will set the time period over which the Average Flow (P863) is to be calculated before being displayed.

## Display Parameters

### Options

#### P800 Display Units

This parameter determines whether the reading displayed is in **Measurement Units (P104)**, or as a **percentage of span**.

OPTION	DESCRIPTION
<b>1 = Measured (Default)</b>	Display is in selected unit's dependent in Mode (P100)
2 = Percentage	Display is in <b>percentage</b> of span dependent in Mode (P100)

#### P801 Decimal Places

This parameter determines the number of decimal places on the reading during run mode. Minimum = 0 (No decimal places), Maximum 3 = (3 decimal Places). **Default = 2** (2 decimal Places).

#### P802 Display Offset

The value of this parameter is added to the reading before it is displayed, in **Measurement Units (P104)**. It does not affect the relay setpoints or the mA output, only the reading on the display.

You could use this feature if for example you wanted to reference the reading to sea level, where you would enter the distance between **Empty Level (P105)** and sea level. If the empty level point is below sea level, then enter a negative value.

#### P804 Display Conversion

The reading is multiplied by the value of this parameter before being displayed. The default is 1.0, but if for example you wanted to display the reading in yards, then set the **Measurement Units (P104)** to feet and set **P804** to 3.

OPTION	DESCRIPTION
<b>0 = Default (Default)</b>	Display reading obtained from selected <b>Mode (P100)</b>
1 = Auxiliary (Optional)	Displays level from optional Aux. Input
2 = Xducer 1	Displays level from Xducer 1
3 = Xducer 2	Displays level from Xducer 2

*P805 Display Source*

**When Ultra Wizard = 1 Level/Volume or 2 Pump/Differential**

This parameter determines which input the display will relate to, it is automatically set to the correct option when selecting the Mode P100, and Xducer P101, under normal circumstances it will not require changing.

**Failsafe**

*P808 Failsafe Mode*

By default, if a fail-safe condition occurs, then the display, relays and the mA output are held at their last **known** values until a valid reading is obtained.

If required, then you can change this so that the unit goes to **high** (100% of span), or **low** (empty) as follows:

OPTION	DESCRIPTION
<b>1 = Known (Default)</b>	Remain at its last <b>known</b> value
2 = High	Will fail to the <b>high</b> value (100% span)
3 = Low	Will fail to the <b>low</b> value (empty)

— See Also P218, P228, P238, P248, P258, 268 - Relay Fail-safe and P840 mA Output Fail-safe

**Important Notice**

In the event of a fail-safe condition occurring, the display, relays and mA Output can be configured to fail to a condition which is independent of each other. To set independent Relay Failsafe see P218, 228, 238, 248, 258, 268. And for independent mA Output Failsafe see P840.

*P809 Failsafe Time*

In the event of a failsafe condition the failsafe timer determines the time before failsafe mode is activated. **Default = 2mins**

If the timer activates, the unit goes into **failsafe**, as determined by **P808 (Display), P218, 228, 238, 248, 258, 268 (Relays)** and **P840 (mA Output)**. When this happens, you will see the message **"Failed Safe!"** on the display, along with a message explaining why (lost echo or transducer fault, for example).

When a valid measurement is obtained then the display, relays and mA output will be restored, and the timer is reset.

## Auxiliary

### P810 Units

This parameter determines whether the **Measurement units (P104)** are displayed on the auxiliary line of the display in run mode.

OPTION	DESCRIPTION
0 = No	Measurement units <b>will not</b> be displayed
<b>1 = Yes (Default)</b>	Measurement units <b>will</b> be displayed

### P811 Alarm Messages

This parameter determines whether notification messages are displayed on the auxiliary line of the display in run mode when an alarm relay is switched on or off. The message is in the form "Alarm High ON", where the 'High' is determined by the setting of the relay **Alarm ID (P212, 222, 232)**.

OPTION	DESCRIPTION
<b>0 = No (Default)</b>	Alarm messages <b>will not</b> be displayed
1 = Yes	Alarm messages <b>will</b> be displayed

### P812 General Control or Pump Messages

This parameter determines whether notification messages are displayed on the auxiliary line of the display in run mode when a pump or general control relay is switched on or off. The message is in the form "General 1 ON", where the number displayed is the number of the relay.

OPTION	DESCRIPTION
<b>0 = No (Default)</b>	Pump messages <b>will not</b> be displayed
1 = Yes	Pump messages <b>will</b> be displayed

### P813 Control Messages

This parameter determines whether notification messages are displayed on the auxiliary line of the display in run mode when a control relay is switched on or off. The message is in the form "Time ON".

OPTION	DESCRIPTION
<b>0 = No (Default)</b>	Control messages <b>will not</b> be displayed
1 = Yes	Control messages <b>will</b> be displayed

*P814 Miscellaneous Messages*

This parameter determines whether notification messages are displayed on the auxiliary line of the display in run mode when a miscellaneous relay is switched on or off. The message is in the form "Clock ON".

OPTION	DESCRIPTION
<b>0 = No (Default)</b>	Miscellaneous messages <b>will not</b> be displayed
1 = Yes	Miscellaneous messages <b>will</b> be displayed

*P815 Auxiliary Source***When Ultra Wizard = 1 Level/Volume or 2 Pump/Differential**

When **P100 = 4 (Average) or 5 (Differential)** the auxiliary display line can be used to display the **level** on any of the two points of measurement.

OPTION	DESCRIPTION
<b>0 = Off (Default)</b>	Auxiliary display not used to display measurement readings.
2 = Xducer 1	Displays level from transducer 1
3 = Xducer 2	Displays level from transducer 2
4 = Rate	Displays Inflow (I) and pumping rate (P)

*P816 Totaliser (R)***When Ultra Wizard = 2 Pump/Differential (Pumped Volume) or 3 Flow**

This parameter determines whether the resettable totaliser will be displayed in the auxiliary line of the display in run mode. When selected, the auxiliary display will scroll between the resettable totaliser and the totaliser units selected. **Default = 0 (Off)**.

When being used to totalise Flow the resettable totaliser can be reset whilst in run mode via the "Totaliser" hot key  by pressing "0" whilst Total (R) is displayed.

*P817 Auxiliary Offset***When Ultra Wizard = 1 Level/Volume or 2 Pump/Differential**

The value of this parameter is added to the reading of the auxiliary display before it is displayed, in **Measurement Units (P104)**.



## **Totaliser**

### *P820 Totaliser*

Displays the current value of the, non-resettable totaliser. During run mode this totaliser can be viewed via the "Totaliser" hot key,  $\Sigma$ . Unlike the resettable totaliser this totaliser cannot be reset whilst in run mode, it can however be reset whilst in program mode by accessing **P820 Totaliser** and entering **zero**.

### *P821 Totaliser (R)*

Displays the current value of the, resettable totaliser. This **totaliser** can be allocated to appear, during **run mode**, on the auxiliary display line (**P816**) or alternatively via the "Totaliser" hot key.

### *P822 Totaliser Decimal Places*

This parameter determines the number of decimal places in the totaliser during run mode. It can be set between 1 and 3. **Default = 2**

*P823 Totaliser Multiplication Factor*

This parameter determines the number of decimal places in the totaliser during run mode. It can be set between 1 and 3. **Default = 2**

Use this parameter if the totaliser increments by to large or small amount, enter the factor by which the actual flow rate is multiplied by before incrementing the totaliser.

*Example:* If flowrate is being calculated and displayed in ltrs/second and it is desired to increment the totaliser in cubic metres select 7 = \*1000.

When viewing, the totaliser display will state, "Units are: L\*1000", and the totaliser will be incremented every 1000 litres. The options are:

OPTION	DESCRIPTION
1 = 1/1000	Totaliser will increment every 1/1000 <sup>th</sup> units of flow
2 = 1/100	Totaliser will increment every 1/100 <sup>th</sup> units of flow
3 = 1/10	Totaliser will increment every 1/10 <sup>th</sup> units of flow
<b>4 = *1 (Default)</b>	Totaliser will increment every 1 units of flow
5 = 10	Totaliser will increment every 10 units of flow
6 = 100	Totaliser will increment every 100 units of flow
7 = 1,000	Totaliser will increment every 1000 units of flow
8 = 10,000	Totaliser will increment every 10,000 units of flow
9 = 100,000	Totaliser will increment every 100,000 units of flow
10 = 1,000,000	Totaliser will increment every 1,000,000 units of flow

*P824 Totaliser Enable*

This parameter determines if the totaliser is enabled or not, the options are as follows:

OPTION	DESCRIPTION
0 = Off	<b>Totaliser will be disabled</b>
<b>1 = On (default)</b>	<b>Totaliser will be enabled</b>

## Bargraph

### P829 Bargraph

By default, the bar graph will be representative of the reading obtained, as determined by the **Mode P100**. When **P100 = 4 (Average)** or **5 (Differential)** the bar graph can be assigned to be representative of the **level** on any of the two points of measurement. This parameter is automatically set to the correct default option when selecting the **Mode P100** and **Xducer (P101)**, and under normal circumstances will not require changing. The options, dependant on the **value** entered for **Mode P100**, are as follows:

OPTION	DESCRIPTION
<b>When Ultra Wizard = 1 Level/Volume or 2 Pump/Differential</b>	
1 = Auxiliary (Optional)	<b>Bargraph</b> will be representative of levels obtained from optional <b>Aux. Input</b> .
<b>2 = Xducer 1 (Default)</b>	<b>Bargraph</b> will be representative of levels obtained from <b>Xducer 1</b>
3 = Xducer 2	<b>Bargraph</b> will be representative of levels obtained from <b>Xducer 2</b>
4 = Avg. Level or Diff	<b>Bargraph</b> will be representative of levels obtained from optional <b>Xducer 1</b>
<b>When Ultra Wizard = 1 Level/Volum</b>	
5 = Volume	<b>Bargraph</b> will be representative of the <b>volume</b> , as selected by <b>Mode P100</b>
6 = Volume (Average)	<b>Bargraph</b> will be representative of the average <b>volume</b> of two points of measurement, as selected by <b>Mode P100</b>
<b>When Ultra Wizard = 3 Flow</b>	
1 = Level	<b>Bargraph</b> will be <b>representative</b> of <b>level</b> .
<b>2 = Head (Default)</b>	<b>Bargraph</b> will be <b>representative</b> of <b>head</b>
3 = Flow	<b>Bargraph</b> will be <b>representative</b> of <b>flow</b> .

***mA Output Parameters***

***Range***

*P830 mA Range*

This parameter determines the range of the mA output, from the following:

OPTION	DESCRIPTION
0 = Off	mA output disabled
1 = 0 to 20 mA	mA output directly proportional to the <b>mA mode (P831)</b> , so if the reading is 0% the output is 0 mA. If the reading is 100% the output is 20 mA.
<b>2 = 4 to 20 mA (Default)</b>	mA output directly proportional to the <b>mA mode (P831)</b> , so if the reading is 0% the output is 4 mA. If the reading is 100% the output is 20 mA.
3 = 20 to 0 mA	mA output inversely proportional to the <b>mA mode (P831)</b> , so if the reading is 0% the output is 20 mA. If the reading is 100% the output is 0 mA.
4 = 20 to 4 mA	mA output inversely proportional to the <b>mA mode (P831)</b> , so if the reading is 0% the output is 20 mA. If the reading is 100% the output is 4 mA.

## Operation

### P831 mA Mode

This parameter determines how the mA Output relates to what is measured. By **default**, it operates the same as the display (**P100**), but it can be set to operate as follows:

OPTION	DESCRIPTION
<b>When Ultra Wizard = 1 Level/Volume, 2 Pump or 3 Flow</b>	
<b>0 = Default</b>	mA output relative to <b>Mode P100</b>
1 = Distance	mA output relative to <b>Distance</b> .
2 = Level	mA output relative to <b>Level</b> .
3 = Space	mA output is relative to <b>Space</b> .
<b>When Ultra Wizard = 1 Level/Volume</b>	
4 = Average Level	mA output is relative to the <b>average level</b> of two points of measurement <b>P100 = 4</b>
5 = Volume	mA output is relative to <b>Volume</b>
<b>When Ultra Wizard = 3 Flow</b>	
4 = OCM Head	mA output is relative to <b>OCM Head</b>
5 = OCM Flow	mA output is relative to <b>OCM Flow</b>
6 = Average Flow	mA output is relative to <b>Average Flow</b>

### Setpoint

By **default**, the mA Output will represent the **empty (0 or 4mA)** dependant on (**P830 mA Range**) and **100%** of the operational **span (20mA)**, but you may wish to have the output represent a section of the operational span. For example, the application has an operational span of 6 metres, but **output** is to **represent empty (0 or 4mA)** dependant on (**P830 mA Range**) to a **level of 5 metres (20mA)**. If so P834 (Low Level) should be set to 0.00 metres and P835 (High Level) should be set to 5 metres.

### P834 mA Low Level

This parameter sets the level, distance, or space, depending on the selected **mA Out Mode (P831)** at which the low mA output will occur (**0 or 4mA** dependant on (**P830 mA Range**)). **Default = 0.000m**

### *P835 mA High Level*

This parameter sets the level, distance or space, depending on the selected **mA Out Mode (P831)** at which the high mA output will occur (**20mA**).

**Default = 6.00m**

### *mA Limits*

#### *P836 mA Low Limit*

This parameter sets the lowest level that the mA output will drop to, the default is 0mA, but you can override this if the device you connect to cannot for example accept less than 2mA, yet you want to use the 0-20mA range.

**Default = 0.00mA**

#### *P837 mA High Limit*

This parameter sets the highest level that the mA output will rise to, the default is 20 mA, but you can override this if the device you connect to cannot for example accept more than 18 mA, yet you want to use the 0-20 mA range. **Default = 20.00mA**

### *mA Trim*

#### *P838 mA Low Trim*

If the device you are connected to is not calibrated, and not showing the correct **low value** (reading), then you can trim it using this parameter. You can either type in the offset directly or use the arrow keys to move the output up and down until you get the expected result (reading) on the device that is connected.

#### *P839 mA 1 High Trim*

If the device you are connected to is not calibrated, and not showing the correct **high value** (reading), then you can trim it using this parameter. You can either type in the offset directly or use the arrow keys to move the output up and down until you get the expected result (reading) on the device that is connected.

## **mA Failsafe**

### *P840 mA Failsafe Mode*

This parameter determines what happens to the mA output in the event of the unit going into fail-safe mode. The **default** is to do the same as the **system fail-safe (P808)**, but this can be overridden to force the mA output to an independent fail-safe mode as follows:

OPTION	DESCRIPTION
<b>0 = Default</b>	mA output will fail as per <b>P808</b>
1 = Hold	mA output will retain its last known value.
2 = Low	mA output will fail to its <b>low</b> condition.
3 = High	mA output will fail to its <b>high</b> condition.

### *P841 mA Allocation*

By default, the mA output will be representative of the reading obtained, as determined by the **Mode P100**. When **P100 = 5 (Volume)** the output can be assigned to be representative of the **level**. This parameter is automatically set to the correct default option when selecting the **Mode P100** and under normal circumstances will not require changing. The options, dependant on the **value** entered for **Mode P100**, are as follows:

OPTION	DESCRIPTION
1 = Auxiliary (Optional)	mA output relates to the optional auxiliary input <b>level</b>
<b>2 = Xducer 1 (Default)</b>	mA output relates to Xducer 1 <b>level</b>
3 = Xducer 2	mA output relates to ducer 2 <b>level</b>
4 = Average level	mA output relates to the <b>average level</b> of two points of measurement. <b>P100 = 4</b>
<b>When Ultra Wizard = 2 Pump/Differential</b>	
5 – Differential	mA output relates to the <b>differential</b> level of two points of measurement. <b>P100 = 6</b>
<b>When Ultra Wizard = 1 Level/Volume</b>	
5 = Volume	mA output relates to the <b>Volume P100 = 5</b>
6 = Volume (Average)	mA output relates to the <b>average volume</b> of two points of measurement. <b>P100 = 6</b>

## Compensation Parameters

### Offset

#### *P851 Measurement Offset*

The value of this parameter is added to the measured distance, in **Measurement Units (P104)**.

This Offset will be added to the level, as derived from the transducer, and will affect everything including the reading on the display, the relay setpoints and the mA output.

### Temperature

#### *P852 Temperature Source*

This parameter determines the source of the temperature measurement. By **default**, it is set to automatic (**P852=1**), which will automatically detect if a temperature sensor is available from the transducer. If for any reason, no temperature input is received, then the **Fixed Temp** value is used, as set by **P854**.

The temperature source can be specifically set as follows:

OPTION	DESCRIPTION
<b>1 = Automatic (Default)</b>	Will automatically select transducer temperature sensor, if available, or fixed temperature (P854) if no temperature sensor found.
2 = Xducer	Always uses temperature reading from transducer.
3 = Fixed	Always uses fixed temperature (P854)
4 = Ext Range "A"	Uses an optional external temperature sensor with an operating range of -25°C to 50°C.
5 = Ext Range "B"	Uses an optional external temperature sensor with an operating range of -25°C to 125°C.



*P853 Allocation***When Ultra Wizard = 1 Level/Volume or 2 Pump/Differential**

This parameter indicates which transducer is being used to obtain the temperature, in the case of the Ultra 5 this can be viewed but cannot be changed.

OPTION	DESCRIPTION
<b>0 = Xducer 1 (Default)</b>	Temperature obtained from Xducer 1
1 = Xducer 2	Temperature obtained from Xducer 2

*P854 Fixed Temperature*

This parameter sets the temperature, in degrees centigrade to be used if **P852 (Temperature Source) = 3. Default = 20°C.**

**Velocity***P860 Sound Velocity*

This parameter allows for the velocity of sound to be changed according to the atmosphere the transducer is operating in. By default, the velocity is set for sound travelling in air at an ambient temperature of 20 degrees centigrade (at 1bar, atmospheric pressure). **Default = 342.72 m/sec.**

*P861 Cal. Dist 1*

This parameter is used to re-calibrate the speed of sound for Xducer 1

*P861 Cal. Dist 1*

This parameter is used to re-calibrate the speed of sound for Xducer 2, when **P100 4 (Avg. Level), 5 (Differential Level) or 6 (Volume Average)**

To obtain best results calibration should be carried out when the level is as near empty as possible and when any vapour present has stabilized.

With the material at a steady level, **view** the value of **P861**, which will indicate the **current distance** as calculated by *Ultra 5* with respect to the current value of P860. Physically **measure** the **distance** from the face of the **transducer** to the surface of the **material level** and enter this value, in Measurement Units P104 and P860 will be automatically updated to compensate for any difference between the displayed and entered values.

## **Stability Parameters**

### **Damping**

Damping is used to damp the display, to enable it to keep up with the process but ignore minor surface fluctuations.

#### *P870 Fill Damping*

This parameter determines the **maximum rate** at which the unit will respond to an **increase in level**. It should be set slightly higher than the maximum vessel fill rate. **Default = 10m/min.**

#### *P871 Empty Damping*

This parameter determines the **maximum rate** at which the unit will respond to a **decrease in level**. It should be set slightly higher than the maximum vessel empty rate. **Default = 10m/min.**

### **Indicator**

#### *P872 Fill Indicator*

This parameter determines the rate at which the LCD **fill** indicator activates. **Default = 10m/min.**

#### *P873 Empty Indicator*

This parameter determines the rate at which the LCD **empty** indicator activates. **10m/min.**

### **Rate**

#### *P874 Rate Update*

This parameter determines the way in which the rate is calculated. If set to **continuous (P874=0)**, then the rate is calculated and displayed continuously, i.e. any change seen from shot to shot is calculated and displayed, but if set to use **values P874=1(Default)** then the **values** set in **P875** and **P876** are used to calculate and display the rate.

#### *P875 Rate Time*

This parameter is the period (in seconds) over which the material level rate of change is averaged before the **Rate Value (P877)** is updated. If the **Rate Distance (P876)** is exceeded before the **Rate Time (P875)** has expired, then the **Rate Value (P877)** will be updated immediately. **Default = 60sec.**

### *P876 Rate Distance*

This parameter is the rate **Measurement Units (P104)** over which the material level must change before the **Rate Value (P877)** is updated. If the **Rate Time (P875)** expires before the **Rate Distance (P876)** is exceeded, then the **Rate Value (P877)** will be updated immediately. **Default = 0.05m**

### *P877 Rate Value*

This parameter displays the current rate of change of material level, in **Measurement Units (P104)** per minute. It is read only.

### *P878 Lower Cutoff*

This parameter is used to select the minimum Rate to be calculated and can be used to eliminate unwanted updates from effects of ripples/waves on the surface of the material.

## **Filters**

The following three parameters can be used to filter out unwanted changes of level caused by a 'rippled' or agitated surface.

### *P880 Gate Mode*

This parameter determines the operation of the gate, which is established around the processed echo and is used to track the echoes movement and update the display. If set to **Fixed**, P880 = 0 (**Default**) then the width of the gate is determined by the value of **P881 Fixed Distance**. When set to **Calculated**, P880=1 then the gate width is automatically calculated and **updated** according to the values of **P870, P871, P874, P875 and P876**. Please consult Pulsar for further information and assistance on changing the value of this parameter.

### *P881 Fixed Distance*

This parameter determines the width of gate to be used in tracking an echo and under normal circumstances will not require changing, but it can be increased in the cases where the surface is moving extremely fast (in excess of 10m/min) to ensure smooth processing of the changing level.

*P882 Process Filter*

This parameter determines the number of ‘cycles’ that will be taken before a change in level is processed and the display updated.

OPTION	DESCRIPTION
1 = Fast	level will be updated every cycle
2 = Medium	level will be updated every 8 cycles
<b>3 = Slow (Default)</b>	level will be updated every 16 cycles

*P884 Peak Percentage*

This parameter is used if you choose a solids application, **P102 Material = 2 (Solids)**, where there maybe angles of repose on the material, and can be used to determine where in the returned echo the displayed level is.

**Default = 50%**

*Echo Processing Parameters*

*Transducer 1 Status*

*P900 Transducer Status*

This parameter shows the current state of the transducer. The value means the following:

OPTION	DESCRIPTION
0= OK	Transducer working correctly.
1= Disabled	Transducer is not being used (mA input is being used instead, so P101=1)
2= Stuck High	Indicates that the power and signal lines on the transducer terminals are crossed over, or the signal line is shorted to earth.
3= Not Found	No transducer is detected.

*P901 Echo Confidence*

This parameter displays the most recent echo confidence from the transducer. It is useful to help find the best mounting location for the transducer, where you should aim to get the highest figure. It is a percentage of confidence that the echo reporting the level is the correct one.

### *P902 Echo Strength*

This parameter displays the most recent echo strength figure for the transducer, where a higher figure indicates a better returned echo.

### *P903 Average Noise*

This is the mean noise reading for the transducer. It is measured while the transducer is not firing and gives an indication of the average amount of electrical noise present on the cabling.

### *P904 Peak Noise*

This is the peak noise reading for the transducer. It is measured while the transducer is not firing and gives an indication of the maximum amount of electrical noise present on the cabling.

### *P905 Sensitivity*

This parameter determines the sensitivity of the unit. Please consult Pulsar for further information and assistance on changing the value of this parameter.

### *P906 Side Clearance*

This parameter is used to set the distance by which the DATEM trace will "stand-off" from around unwanted echoes such as obstructions. Please consult Pulsar for further information and assistance on changing the value of this parameter.

## ***Transducer 2 Status***

### **When Ultra Wizard = 1 Level/Volume or 2 Pump/Differential**

#### *P910 - 916 Transducer 2*

These parameters contain the same information as detailed in Transducer 1 Status, for Transducer 2.

**DATEM Parameters**

The following two parameters are used to make changes to the DATEM trace such as setting it to its default value or using it to select a particular echo, both parameters are accessed directly by simply entering **Program Mode** then typing in the **parameter number** and pressing **ENTER**.

*P020 Set DATEM 1*

This parameter allows DATEM to be reset to its default value or alternatively allows the user to “Capture” a DATEM trace. It should be noted that when using option 1 = Capture, all echoes seen will be eliminated by DATEM.

OPTION	DESCRIPTION
0 = Quit	Exit without any change to the present DATEM trace.
1 = Capture	DATEM trace of entire visible range taken and all echo returns referenced out.
2 = Default	DATEM trace will assume its default value
3 = Def Reset	Default DATEM to factory settings.
4 = Set Min DATEM	When set, DATEM levels at this point will be accepted as a minimum.

*P021 Set Distance*

Allows the user or service personnel to determine which echo is to be displayed. On start-up, if the unit displays an incorrect reading then simply enter the distance from the transducer to the required level and, if an echo is present at this point, the Gate will establish itself around the chosen echo, DATEM will update in front of the Gate and reference out any other unwanted echoes.

It should be noted that DATEM will reset to default values whilst performing this function, and reform itself once it has selected an echo.

**Important Notice**

Enter the distance measurement from the face of transducer to the target, in units of measurement (P104) and press ENTER.

## System Parameters

### Passcode

#### *P921 Enable Code*

**Enables** the passcode (**P922**), which means the passcode must be entered to go into program mode. If **disabled** (set to **0**), then no passcode is required, and ENTER is used to enter program mode. **Default = 1 (Enabled)**

#### *P922 Passcode*

This is the passcode that must be used to enter program mode. The **default** is **1997**, but this can be changed to another value from 0 to 9999.

### Backup

#### *P925 Parameter Backup & Restore*

This parameter is used to make a backup of all parameters, for example to ensure a default set is maintained within the unit. If alterations are made to the parameters that do not work as intended, then the backup set can be restored into the unit.

You can make two separate backup copies if you wish, called backup 1 and backup 2, and restore from either. The options are:

OPTION	DESCRIPTION
1= Backup 1	Make backup to area 1 of all parameters
2= Backup 2	Make backup to area 2 of all parameters
3= Restore 1	Restore all parameters from area 1
4= Restore 2	Restore all parameters from area 2

### **System Information**

*The following three parameters do not affect how the unit performs, but details, contained in them, may be required, by Pulsar, when making technical enquiries.*

#### *P926 Software Revision*

This parameter will display the current software revision. It is read only and cannot be changed.

#### *P927 Hardware Revision*

This parameter will display the current hardware revision. It is read only and cannot be changed.

#### *P928 Serial Number*

This parameter will display the serial number of the unit. It is read only and cannot be changed.

#### *P929 Site Identification*

This parameter allows you to give each unit an individual reference number, for identification purposes. You can set any number between 1 and 99999.

#### *P930 Factory Defaults*

This parameter resets all parameter values to the original Factory Set values that were installed when the unit was tested before despatch to you.

To reset parameters, enter **1 (Yes)**, and press ENTER, then you will see a message "Entr if sure", you should press ENTER again. If you press any other key at this point, the parameters will not be reset, and you will see a message confirming this.

Once you have done this, program the unit, to the desired application.



## **Date & Time**

The date and time is used, to control specific relay functions and date stamp certain events that are contained in the Data Logs. It is also used in conjunction with the system watchdog that keeps an eye on the times the unit has started.

### *P931 Date*

This parameter displays the **current date**, in the format as set by **P933 (Date Format)** and can be reset if required.

### *P932 Time*

This parameter displays the **current time** and can be reset if required, in the format HH: MM (24-hour format). This is set initially at the factory for UK time.

### *P933 Date Format*

This parameter allows you to alter the format that the date is displayed to your choice of DD: MM: YY, MM: DD: YY or YY: MM: DD. The default is DD: MM: YY.

## **LED Colour**

Each relay has an associated LED, located on the unit's front panel, which indicates the status of the relay. By default, the LED of any relay that has been programmed but is in its "OFF" state will be illuminated 'yellow'. When "**ON**" **alarm** relays will cause the **LED** to illuminate **Red** and **pump, control** and **miscellaneous** relays will cause the **LED** to illuminate **green**. LED's of any relays that have not been programmed will not be illuminated. Customised settings for the colour of LED's can be achieved by using the following parameters.

### *P935 Off Relay Colour*

This parameter selects the colour that a **programmed relay** should be when it is in its "**OFF**" state. The **default** is **3 = yellow**, but can be changed to 'no colour', red or green.

### *P936 Alarm Relay Colour*

This parameter selects the colour that an **alarm** relay should be when it is in its "**ON**" state. The **default** is **1 = red**, but can be changed to 'no colour', green or yellow.

### *P937 Pump Relay Colour*

This parameter selects the colour that a **pump** relay should be when it is in its "ON" state. The **default** is **2 = green**, but can be changed to 'no colour', red or yellow.

### *P938 Control Relay Colour*

This parameter selects the colour that a **control** relay should be when it is in its "ON" state. The **default** is **2 = green**, but can be changed to 'no colour', red or yellow.

### *P939 Miscellaneous Relay Colour*

This parameter selects the colour that a **miscellaneous** relay should be when it is in its "ON" state. The default is **2 = green**, but can be changed to 'no colour', red or yellow.

All relays that are not programmed will show, 'no colour', i.e. they are off.

#### **Important Notice**

When a relay has been failed, due to a fail signal having been received on its associated digital input, the relay LED will flash on and off, between yellow and red, to indicate that the relay has been failed but not put out of service. After the maximum attempts P300 have been made to start the device relay and it is put out of service then the relay LED will remain lit on red until such time that the input is reset.

### *Watchdog*

You can check how many times the unit has been switched on and look at the date and time of the last ten starts. This can be useful if there have been power failures or if for any reason the Ultra 5 restarts due to a fault condition. The Ultra 5 can be backed up from a battery which automatically cuts in during power failure, battery backed up units will continue uninterrupted operation and therefore will not register a loss of mains power. If, however the battery was to fail during a mains power interruption, a start-up would be recorded once power has been restored.

The following parameters can be accessed by directly entering the parameter number. To do this, enter the **program mode** and then **type** in the appropriate **parameter number**.

### *P940 Number of Starts*

This parameter shows how many times the unit has been powered up.

### *P941-P960 Start Date & Time*

Parameters **P941** and **P942** show the **date** and **time** that the unit was last started. There are **ten start dates & times** recorded, which are parameters **P943-P960**. The first on the list are the most recent, and the last ones are the oldest. These are read only and cannot be changed.

## *Daylight Saving Time*

### **Important Notice**

In order to ensure the correct operation of Daylight-Saving Time P932 Time should be checked, and adjusted if necessary, to ensure that it is set for the current valid time.

### *P970 DST Enable*

When **Enabled** (set to **1**) the internal clock will be automatically adjusted to compensate for the difference between standard time and **Daylight-Saving Time**. **Default = 1 (Yes)**

### *P971 DST Difference*

This parameter sets the time difference between standard time and **Daylight-Saving Time**. The time difference is entered in HH:MM. **Default = 01:00**

### *P972 DST Start Time*

This parameter is used to set the **time** of day at which **Daylight-Saving Time** will **start**, the time is entered in the format HH: MM (24-hour format). **Default = 02:00**

*P973 Start Day*

Use this parameter to enter the **day** of the week (**P974**) that **Daylight Saving Time** is to **start**.

OPTION	DESCRIPTION
2= Monday	<b>DST will start on a Monday</b>
3= Tuesday	<b>DST will start on a Tuesday</b>
4= Wednesday	<b>DST will start on a Wednesday</b>
5= Thursday	<b>DST will start on a Thursday</b>
6= Friday	<b>DST will start on a Friday</b>
7= Saturday	<b>DST will start on a Saturday</b>
<b>8= Sunday (Default)</b>	<b>DST will start on a Sunday</b>

*P974 Start Week*

This parameter will determine the **week** of the month (**P975**) in which **Daylight-Saving Time** is to **start**.

OPTION	DESCRIPTION
1= Week 1	<b>DST will start on day (P973) in the first week (P974) of the month (P975).</b>
2= Week 2	<b>DST will start on day (P973) in the second week (P974) of the month (P975).</b>
3= Week 3	<b>DST will start on day (P973) in the third week (P974) of the month (P975).</b>
4= Week 4	<b>DST will start on day (P973) in the fourth week (P974) of the month (P975).</b>
<b>5= Last (Default)</b>	<b>DST will start on day (P973) in the last week (P974) of the month (P975).</b>

*P975 Start Month*

This parameter is used to select the **month**, in which **Daylight-Saving Time** will **start**.

OPTION	DESCRIPTION
1= January	<b>DST will start</b> during the month of <b>January</b>
2= February	<b>DST will start</b> during the month of <b>February</b>
<b>3= March (Default)</b>	<b>DST will start</b> during the month of <b>March</b>
4= April	<b>DST will start</b> during the month of <b>April</b>
5= May	<b>DST will start</b> during the month of <b>May</b>
6= June	<b>DST will start</b> during the month of <b>June</b>
7= July	<b>DST will start</b> during the month of <b>July</b>
8= August	<b>DST will start</b> during the month of <b>August</b>
9= September	<b>DST will start</b> during the month of <b>September</b>
10= October	<b>DST will start</b> during the month of <b>October</b>
11= November	<b>DST will start</b> during the month of <b>November</b>
12= December	<b>DST will start</b> during the month of <b>December</b>

*P976 DST End Time*

This parameter is used to set the **time** of day at which **Daylight-Saving Time** will **end**, the time is entered in the format HH: MM (24-hour format).  
**Default = 02:00.**

*P977 DST End Day*

Use this parameter to enter the **day** of the week (**P974**) that **Daylight Saving Time** is to **end**.

OPTION	DESCRIPTION
2= Monday	DST will <b>end</b> on a <b>Monday</b>
3= Tuesday	DST will <b>end</b> on a <b>Tuesday</b>
4= Wednesday	DST will <b>end</b> on a <b>Wednesday</b>
5= Thursday	DST will <b>end</b> on a <b>Thursday</b>
6= Friday	DST will <b>end</b> on a <b>Friday</b>
7= Saturday	DST will <b>end</b> on a <b>Saturday</b>
<b>8 = Sunday (Default)</b>	DST will <b>end</b> on a <b>Sunday</b>

*P978 End Week*

This parameter will determine the **week** of the month (**P975**) in which **Daylight-Saving Time** is to end.

OPTION	DESCRIPTION
1= Week 1	DST will <b>end</b> on <b>day (P973)</b> in the <b>first</b> week ( <b>P974</b> ) of the <b>month (P975)</b> .
2= Week 2	DST will <b>end</b> on <b>day (P973)</b> in the <b>second</b> week ( <b>P974</b> ) of the <b>month (P975)</b> .
3= Week 3	DST will <b>end</b> on <b>day (P973)</b> in the <b>third</b> week ( <b>P974</b> ) of the <b>month (P975)</b> .
4= Week 4	DST will <b>end</b> on <b>day (P973)</b> in the <b>fourth</b> week ( <b>P974</b> ) of the <b>month (P975)</b> .
<b>5= Last (Default)</b>	DST will <b>end</b> on <b>day (P973)</b> in the <b>last</b> week ( <b>P974</b> ) of the <b>month (P975)</b> .

### *P979 End Month*

This parameter is used to select the **month**, in which **Daylight-Saving Time** will **end**.

OPTION	DESCRIPTION
1= January	<b>DST will end</b> during the month of <b>January</b>
2= February	<b>DST will end</b> during the month of <b>February</b>
3=March	<b>DST will end</b> during the month of <b>March</b>
4= April	<b>DST will end</b> during the month of <b>April</b>
5= May	<b>DST will end</b> during the month of <b>May</b>
6= June	<b>DST will end</b> during the month of <b>June</b>
7= July	<b>DST will end</b> during the month of <b>July</b>
8= August	<b>DST will end</b> during the month of <b>August</b>
9= September	<b>DST will end</b> during the month of <b>September</b>
<b>10= October (Default)</b>	<b>DST will end</b> during the month of <b>October</b>
11= November	<b>DST will end</b> during the month of <b>November</b>
12= December	<b>DST will end</b> during the month of <b>December</b>

### *Device Comm.*

#### *RS232 Set Up*

##### *P061 Comms Baud*

This parameter is used to set the speed (Baud Rate) of the RS232 communications and can be changed to suit the connecting device.

**Default = 19200**

#### *RS 485 Set Up*

Please refer to the RS485 communications manual for availability of parameters and details of their options. This can be found in the downloads section of the Pulsar website:

<https://pulsarmeasurement.com/downloads/instruction-manuals/>

**Remote Alarm**

When a Modem is connected, via the RS232 port, (Consult Pulsar or your local distributor for further details), the following parameters are used to set up the Ultra 5 so that when the level reaches a specific alarm point, as determined by the setting of the relay(s) the unit will dial and connect to a remote telephone number to provide details of the event.

*P144 Call Type*

This parameter determines what type of connection is made via the modem.

OPTION	DESCRIPTION
<b>0 = Off (Default)</b>	Remote alarm function is disabled
1 = Ring	This option initiates a connection to a remote modem/computer which will then allow remote communication with the unit. Please consult Pulsar or your local distributor for further details.
2 = SMS	This option initiates a predetermined message which is sent to the remote telephone number detailing date and time the alarm was initiated, the site ID, alarm condition and level at the time the alarm was initiated.

*P145 Tel. No.1*

This parameter is used to enter the number of '0's that appear at the beginning of the telephone number to be dialled to receive the message.

OPTION	DESCRIPTION
0= None	No '0's present at the beginning of the telephone number to be dialled.
<b>1 = Add 0 (Default)</b>	1 '0' present at the beginning of the telephone number to be dialled.
2= Add 00	2 '0's present at the beginning of the telephone number to be dialled.



### *P146 Tel. No2*

This parameter is used to enter the next 6 digits, following the '0's, of the telephone number to be dialled. If there are less than 6 digits following the '0's, then just enter the digits required, if there are more than 6 digits following the '0's then enter the first 6 digits and then proceed to P147 to enter the remainder.

### *P147 Tel. No3*

This parameter is used to enter any remaining digits of the telephone number to be dialled after completion of P145 and P146 above.

### **Example**

Telephone number to be dialled is: 0 1234 123456

P145 Tel. No. 1 = 1 (One '0' at the beginning of the telephone number)

P146 Tel. No. 2 = 123412 (The next 6 digits following the '0's).

P147 Tel. No. 3 = 3456 (Remaining digits of telephone number).

### *P148 Timed Out*

This parameter will set the time period that the unit will wait for a reply before disconnecting.

**Default = 90 seconds**

### *P149 Retry No.*

This parameter will set the number of times the telephone number will be re-dialled if no reply is received. If set to '0' then the number will be re-dialled continually until a reply is received, if set to '-1' then the number will not be re-dialled at all. Any other value entered between 1 and 99 will determine the number of re-dials to be attempted.

**Default = 0**

## Test Parameters

### Simulation

#### *P980 Simulate*

Test mode is used to simulate the application and confirm that all parameters and relay setpoints have been entered as expected. During simulation, there is a choice of whether the relays will change state (hard simulation) or not (soft simulation), but the LED's will always change colour as programmed, and the current output will change. If you want to test the logic of the system that the relays are connected to then select a hard simulation, but if you do not want to change the relay state, then select a soft simulation.

There are two simulation modes, **automatic** and **manual**. Automatic simulation will move the level up and down between empty level or the pre-determined **Start Level (P983)** and Pump/Control relay switch points, if you wish to change the direction of the level movement e.g. to go beyond relay setpoints, this can be done by using the arrow keys. In manual simulation, using the arrow keys will allow you to move the level up and down as required.

The choices for you to enter are as follows.

- 1= Manual soft simulation
- 2= Automatic soft simulation
- 3= Manual hard simulation
- 4= Automatic hard simulation

Whilst in Automatic hard simulation (**P980 = 4**) the switching of digital inputs can be simulated by pressing the corresponding numeric key to the input to be switched, each time the numeric key is pressed it will toggle the input between On and Off.

To return to program mode, press 'CANCEL' and test mode will end.

### Important Notice

Pump start delay (which by default is 10 seconds) is set to 0 during simulation.

### *P981 Increment*

By **default**, simulation mode will move by **0.1m** steps in manual simulation and by **0.1m/min** in automatic simulation. Altering the increment can change this value.

### *P982 Rate*

In automatic mode, the rate at which the level will move up and down, is determined by distance, **P981 Increment** and the time, **P982 Rate** which by **default** is set to **1min** and can be changed as required. To increase the rate at which the level moves increase the **Increment (P981)** or decrease the **Rate (P982)**. To decrease the rate at which the level moves decrease the **Increment (P981)** or increase the **Rate (P982)**.

### *P983 Start Level*

When using automatic simulation this parameter can be used to pre-determine the point at which the simulated level will start at and return to. This can be used to simulate the lowest point to which the level would normally operate.

### *P984 Inc. Change*

When using automatic simulation, you can incrementally increase or decrease the rate whilst running simulation. The rate is increased /decreased incrementally by the value **P984 (Incremental Change)** by using the "**decimal point**" key to **increase** and the "**plus/minus**" key to **decrease** the rate of change.

**Default = 0.1m**

## **Hardware**

### *P990 Self Test*

If you enter 1 for this parameter, then the unit will perform a self-test. This will confirm that the various parts of the circuitry are working correctly. You will see confirmation messages that the clock and the EEPROM are working correctly, and error messages for any parts that fail.

### *P991 Hard Test*

When this parameter is selected, the unit will test the following in turn.

- **LED's.** Watch them change colour as shown on the display, and press, ENTER, if they operated as shown.
- **Relays.** Press a numeric key corresponding to the number of the relay you wish to test, and the relay will change state each time the key is pressed. If you press any other key, other than a valid relay number, then the test will end.
- **Segments.** All the segments on the LCD are lit up, so you can see if they all work. Press, ENTER, to end the test. The LED's all go green at the same time.
- **Keys.** You should press each key, to confirm it works, with a counter showing how many more keys you have to press. Be sure to press the **CANCEL** key last, as this will show if all keys were pressed or not. If they were not, then an error message is displayed.

### *P992 mA Out Test*

This parameter will allow you to force a specified current on the mA output, to test the equipment that it is connected to, and to make sure the unit is working correctly. The figure you enter will be generated by the mA output.

### *P994 Transducer Test*

If you enter 1 for this parameter it will continually fire the transducer, so you can check the wiring, until you press any key to cancel.

### *P995 Keys Test*

You should press each key, to confirm it works, with a counter showing how many more keys you have to press. Press the **CANCEL** key last, as this will confirm if all keys were pressed or not. If they were not, then an error message is displayed.

### *P996 Relay Test*

Press a numeric key corresponding to the number of the relay you wish to test, and the relay will change state each time the key is pressed. If you press any other key, other than a valid relay number, then the test will end.

### *P992 mA IN Test (Optional)*

This parameter will allow you to test the mA input, by injecting a known mA signal from an external source you can check the unit is working correctly and as expected.

## CHAPTER 9 TROUBLESHOOTING

This section describes many common symptoms, with suggestions as to what to do. If the issue persists, please contact your local Pulsar distributor.

SYMPTOM	WHAT TO DO
Display blank, transducer not firing.	Check power supply, voltage selector switch and fuse.
Displays "No Xducer"	Check wiring to transducer.
Displays "Xducer Flt"	There is a fault with the transducer wiring, so check wiring to transducer.
Displays 'Failed Safe'	The transducer has not been able to lock on to a target. Check transducer wiring, check P900 status. Check to see if transducer is 'clicking', check for any obstructions in the application.
Incorrect reading being displayed for current level.	Measure actual distance from transducer head to surface of material. Enter Program Mode and directly access P21 (Set Distance) type in the measured distance, ENTER, ENTER again when prompted, wait until SET displayed and return to Run Mode, display should now update to correct reading.
Material level is consistently incorrect by the same amount.	Check empty level, (P105) display offset, (P802) and measurement offset (P851).
LED's change colour at relevant relay switch points but relays do not change state.	Check supply to unit and ensure voltage selector set to correct position.

## CHAPTER 10 DISPOSAL

Incorrect disposal can cause adverse effects to the environment.

Dispose of the device components and packaging material in accordance with regional environmental regulations including regulations for electrical \ electronic products.

### Transducers

Remove power, disconnect the Transducer, cut off the electrical cable and dispose of cable and Transducer in accordance with regional environmental regulations for electrical \ electronic products.

### Controllers

Remove power, disconnect the Controller, and remove battery (if fitted).

Dispose of Controller in accordance with regional environmental regulations for electrical \ electronic products.

Dispose of batteries in accordance with regional environmental regulations for batteries.



 EU WEEE Directive Logo

This symbol indicates the requirements of Directive 2012/19/EU regarding the treatment and disposal of waste from electric and electronic equipment.

## NOTES



**[www.pulsarmeasurement.com](http://www.pulsarmeasurement.com)**

**SUPPORT@PULSARMEASUREMENT.COM**

*Copyright © 2020 Pulsar Measurement Ltd.*

*Registered Address: 1 Chamberlain Square CS, Birmingham B3 3AX*

*Registered No.: 3345604 England & Wales*

*Rev 1.0*