

Instruction Manual

PORTABLE TYPE ULTRASONIC FLOWMETER

TYPE: CONVERTER PUX
DETECTOR PSX2

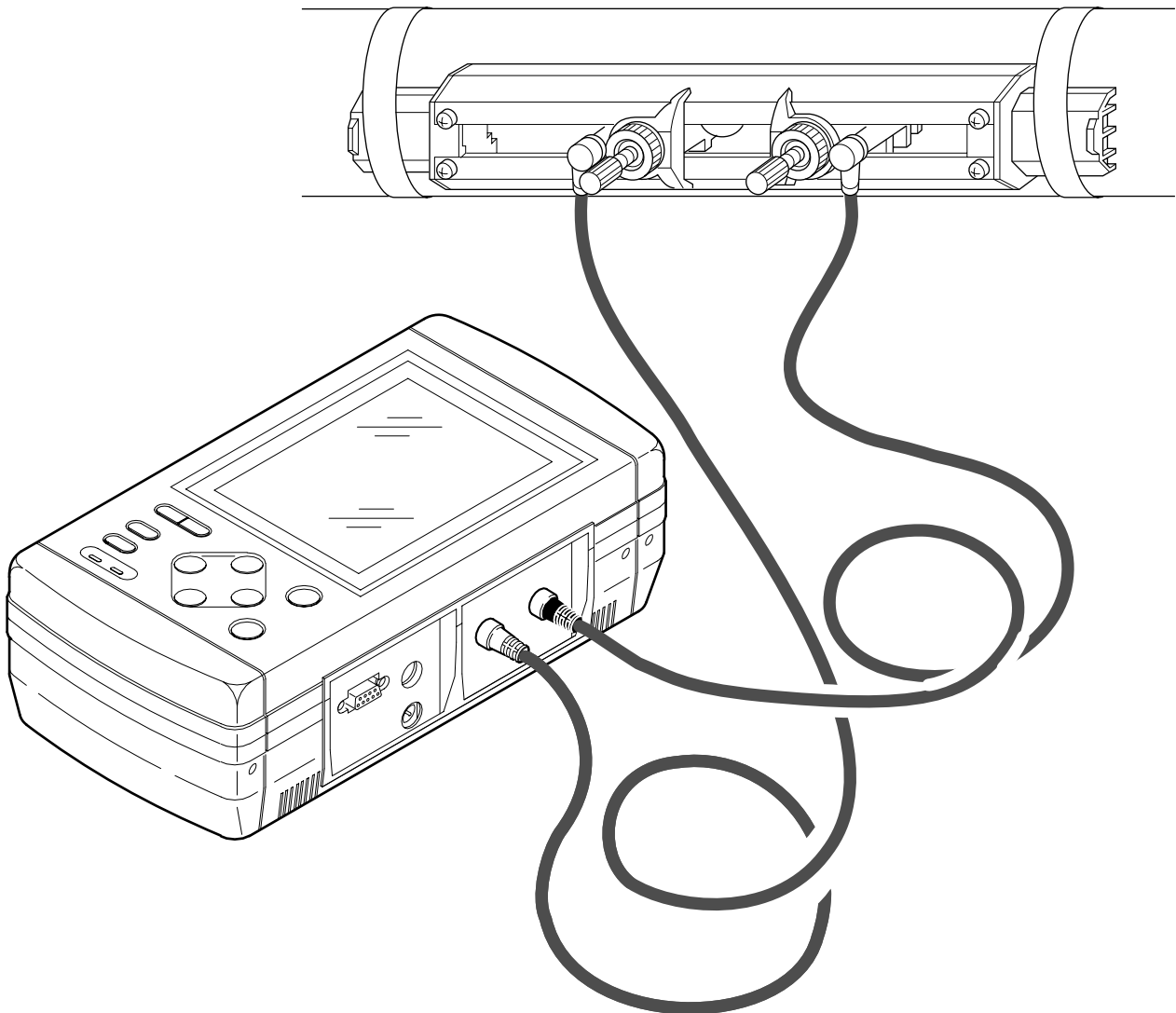

PREFACE

You are now a proud owner of Dwyer Instruments ultrasonic flowmeter (Model PUX).

This manual explains cautions in use, wiring, operation, installation, troubleshooting, maintenance, and options of the portable type ultrasonic flowmeter. Please read through the manual before using the instrument.

Keep this manual in a convenient location for future reference.

Manufacturer : Dwyer Instruments, Inc.
Type : Described on nameplate on main frame
Date of manufacture : Described on nameplate on main frame
Product nationality : Japan

Request

- Copy of contents of this manual in part or whole is not authorized without permission.
- Contents of the manual are subject to change without prior notice.

© Dwyer Instruments, Inc.

Issued in June 2007

BULLETIN F-68
CONTENTS

1. OVERVIEW	1 - 1
2. CHECK OF DELIVERED ITEMS	2 - 1
2.1 On purchase of converter	2 - 1
2.2 On purchase of detector	2 - 2
3. NAME AND EXPLANATION OF EACH PART	3 - 1
3.1 Name and explanation of main unit and sensor	3 - 1
3.2 Explanation of keys	3 - 2
4. POWER UP	4 - 1
4.1 Operating power supply	4 - 1
4.2 Turning on power supply	4 - 2
5. WIRING	5 - 1
5.1 Connection of dedicated cables	5 - 1
5.2 Connection of analog input/output cable	5 - 1
5.3 Connection of RS-232C cable	5 - 2
6. INPUT OF PIPING SPECIFICATIONS	6 - 1
6.1 Display of pipe setup screen	6 - 1
6.2 Entry of site name (measurement is possible without entry)	6 - 3
6.3 Outer diameter of piping (unit: mm) (range: 13 to 6000 mm)	6 - 4
6.4 Piping material	6 - 5
6.5 Wall thickness (unit: mm)	6 - 6
6.6 Lining material	6 - 7
6.7 Lining thickness (unit: mm) (range: 0.01 to 100.00 mm)	6 - 8
6.8 Kind of fluid	6 - 9
6.9 Selection of sensor mounting method	6 - 10
6.10 Kind of sensor	6 - 11
6.11 Transmission voltage (used when an indicator is 1 or less during measurement)	6 - 12
7. MOUNTING OF DETECTOR	7 - 1
7.1 Selection of mounting location	7 - 1
7.2 Selection of mounting method	7 - 3
7.3 Treatment of detector mounting face	7 - 4
7.4 How to mount small size (standard) sensor and small outer diameter sensor to pipe	7 - 5
7.5 How to mount large size sensor	7 - 6
7.5.1 How to determine mounting position (large sensor)	7 - 6
7.5.2 How to connect large size sensor	7 - 7
7.5.3 How to mount large size sensor to pipe	7 - 8

7.6	How to mount high temperature sensor to pipe	7 - 9
7.7	How to mount medium diameter sensor to pipe	7 - 10
7.8	How to fold gauge paper (used for determining mounting position)	7 - 10
8.	MEASUREMENT	8 - 1
9.	SETTING OPERATION (APPLICATION)	9 - 1
9.1	How to use SITE SETUP function (SITE SETUP page)	9 - 2
9.1.1	PARAMETER MEMORY: when registering data which are set and calibrated on the page	9 - 2
9.1.2	ZERO ADJUST: when performing zero adjustment	9 - 3
9.1.3	RESPONSE SET: when changing output response	9 - 3
9.1.4	OUTPUT CORRECTION: when calibrating measured value (output calibration function)	9 - 4
9.1.5	CUT OFF: output cut off at low flow rate (low flow cutoff function)	9 - 5
9.1.6	TOTALIZE: when performing the integration process of measured data (totalize)	9 - 6
9.2	Setting of logging function (data logger page)	9 - 7
(1)	SETUP: when setting logging of measured data	9 - 8
(2)	GRAPH: when checking logged data on screen	9 - 11
(3)	PRINT: when printing logged data in text	9 - 13
(4)	DELETE: when deleting logged data	9 - 14
(5)	START: when starting logging [logging starts by conditions set in (1), "SETUP"]	9 - 14
9.3	Setting of system (page title: SYSTEM SETUP)	9 - 15
9.3.1	CLOCK SET: when setting the clock (set the present time)	9 - 15
9.3.2	COMMUNICATION: when setting serial communication (data communication to personal computer)	9 - 15
9.3.3	SYSTEM OF UNITS: when setting the measurement and setting unit system [selection of meter system and inch system]	9 - 16
9.3.4	MEASUREMENT METHOD: when changing measurement method	9 - 17
9.3.5	MEMORY INITIALIZE: all setting parameters and logger data are initialized. ...	9 - 17
9.4	Setting of analog input/output (analog page)	9 - 18
9.4.1	Setting of analog input	9 - 18
9.4.2	Setting of analog output	9 - 20
9.5	Use of printer function (printer page)	9 - 23
9.5.1	Selection of mode	9 - 23
9.5.2	Selection of items to print	9 - 24
9.5.3	Setting of print time	9 - 27
9.5.4	To set printing intervals	9 - 31
9.5.5	To set graph scale in graph mode	9 - 31
9.5.6	Printing	9 - 32
9.5.7	Printing stop	9 - 32

9.6	System check function (system check page)	9 - 33
9.6.1	ERROR CHECK	9 - 33
9.6.2	SIGNAL CHECK	9 - 35
9.6.3	OUTPUT CHECK	9 - 38
9.6.4	VERSION NO.	9 - 38
10.	MAINTENANCE AND CHECKUP	10 - 1
11.	ERROR AND HANDLING	11 - 1
11.1	Error in LCD display	11 - 1
11.2	Error of key	11 - 1
11.3	Error in measured value	11 - 2
11.4	Error in analog output	11 - 5
11.5	Display of error	11 - 5
12.	SPECIFICATIONS FOR SERIAL TRANSMISSION (RS-232C)	12 - 1
13.	HOW TO USE PRINTER	13 - 1
13.1	How to connect printer	13 - 1
13.2	How to load printer roll sheet	13 - 2
14.	REPLACEMENT OF BUILT-IN BATTERY	14 - 1
15.	APPENDIX.....	15 - 1
15.1	Piping data	15 - 1
15.2	Command tree	15 - 7
15.3	Specifications	15 - 8
15.4	Q & A	15 - 10







WARNING SYMBOLS AND THEIR MEANINGS

Be sure to observe the following precautions. They offer important information on safety.

- The degree of injuries or damages resulting from improper handling of this device is indicated by different symbols.

Symbol	Meaning
 CAUTION	Improper handling of this device may cause dangerous situations that result in personal injury or property damage.

- The following symbols describe items to be observed.

Symbol	Meaning	Symbol	Meaning
	The symbol indicates "prohibition".		Do not modify this device.
	The symbol indicates "mandatory" action to be taken.		Be sure to pull out the plug.
	The symbol provokes "cautions".		Be careful. It may result in fire.

SAFETY PRECAUTIONS

Be sure to read this “Safety Precautions” carefully beforehand for the correct and safe use of this device.



Do not touch the switch with a wet hand.



Prohibition

Do not touch the switch with a wet hand. Otherwise it may result in electric shock.

Do not break or pull the power cord.



Prohibition

Do not put heavy things on the power cord. Do not modify or pull the power cord. Otherwise it may break and result in electric shock and fire.

Do not modify.



Modification is prohibited.

Do not modify this device. Otherwise it may result in an accident.

Do not use electric parts soaked in water



Prohibition

Replace electric parts or wires soaked in water due to floods or some other reasons with new ones. Otherwise it may result in electric shock or fire.

Do not repair.



Repair should be made only by authorized servicepersons. Ask your dealer for the repair. Improper repair work may result in electric shock, fire, or injury.

Pull out the plug immediately in case of an emergency



Pull out the plug

In case abnormal odor, smoke or fire is perceived, pull the power plug immediately. Ask an authorized serviceperson or your dealer for repair. Otherwise it may result in electric shock or fire.



CAUTION

Keep warning labels clean.



Clean or replace the warning labels so that they can always be read correctly. Otherwise it may result in an accident.

Inspect the power plug periodically.



Inspect the power plug once every 6 months. Wipe the dust off the plug and insert it securely. Otherwise it may result in electric shock or fire.

Ask an authorized waste disposal specialist for disposal.



Do not dispose the device without proper authorization. Otherwise it may cause environmental pollution or result in an accident.

Match power capacity with the device ratings.



Fire hazard

Be sure to connect the device to the power with sufficient allowable voltage and current. Otherwise it may result in fire.

Do not splash water.



Prohibition

Do not wash or splash water on the electrical parts inside the device. Otherwise it may result in electric shock.

Use an exclusive power adapter and built-in battery



Prohibition

Do not use a power adapter or built-in battery that is not exclusive to the main unit. Otherwise it may break and cause failure.

Be careful when carrying the device



When carrying the device, exercise care to avoid physical shock or vibration. Otherwise it may cause failure.

Use the device in favorable environment.



Do not use the device in an environment subjected to dust or corrosive gases. Otherwise it may cause failure.

1. OVERVIEW

This is a portable type ultrasonic flowmeter that allows easy measurement of flow rates in pipes by installing a sensor on the outside of pipes.

A combination of the latest electronics and digital signal process technologies makes this instrument compact, designed for improvement of performance and easy operation.

2. CHECK OF DELIVERED ITEMS

2.1 On purchase of converter (type: PUX)

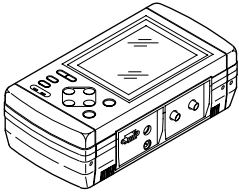
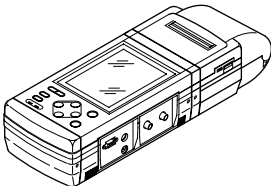
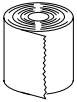
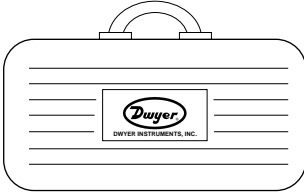
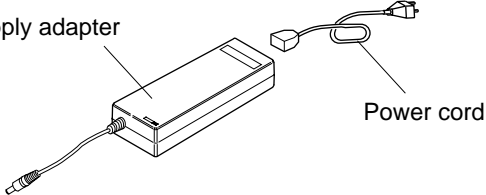
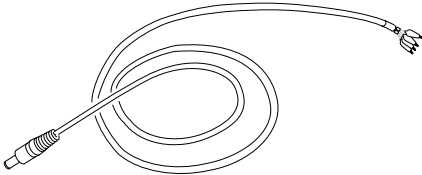
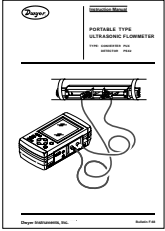
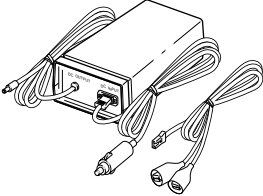
<p>Conversion unit</p>	<p>Without printer</p> 	<p>With printer</p>  <p>Roll paper</p> 
<p>Carrying case</p>		
<p>AC power supply adapter Power cord</p>		
<p>Analog input/output cord</p>		
<p>Instruction manual (BULLETIN F-68)</p>		
<p>(option) DC power supply adapter</p>		

2.2 On purchase of detector (type: PSX2)

The following parts will be delivered.
So, make sure all the parts are delivered.

(1) Main unit

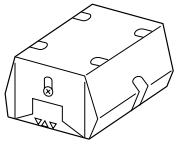

Large type (2pcs)
(Type: PSX2 D)

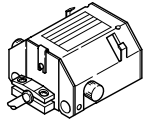

Middle type (2pcs)
(Type: PSX2 C)

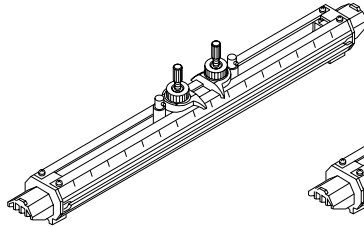

Small type (standard)
(Type: PSX2 A & E)

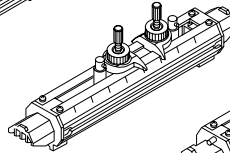



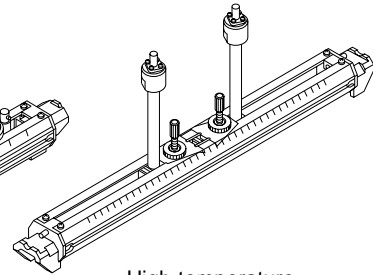

Small diameter
(Type: PSX2 B)

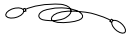

High-temperature
(Type: PSX2 HT)

(2) Accessories

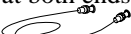
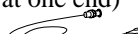
	Large type	Medium type	Small type	Small diameter	High temperature	Quantity	Remarks
• Fastening spring 	○	○	—	—	—	2 pcs	
• φ 2mm wire rope 	○	○	—	—	—	2 pcs	
• Plastic cloth belt 	—	—	○	○	—	1 pc	
• Stainless steel beld 	—	—	—	—	○	4 pcs (long) 2 pcs (short)	
• Silicone grease 	○	○	○	○	—	1 pc	Maker: Shinetsu Chemical Industry Type: G40M (100g)
• Grease for high temperature 	—	—	—	—	○	1 pc	Maker: Shinetsu Chemical Industry Type: KS62M (100g)
• Cable for exclusive use (BNC at both ends) 	—	—	○	○	○	2 pcs	
• Cable for exclusive use (BNC at one end) 	○	○	—	—	—	2 pcs	Note) Supplied for PSX2 D only

3. NAME AND EXPLANATION OF EACH PART

3.1 Name and explanation of main unit and sensor

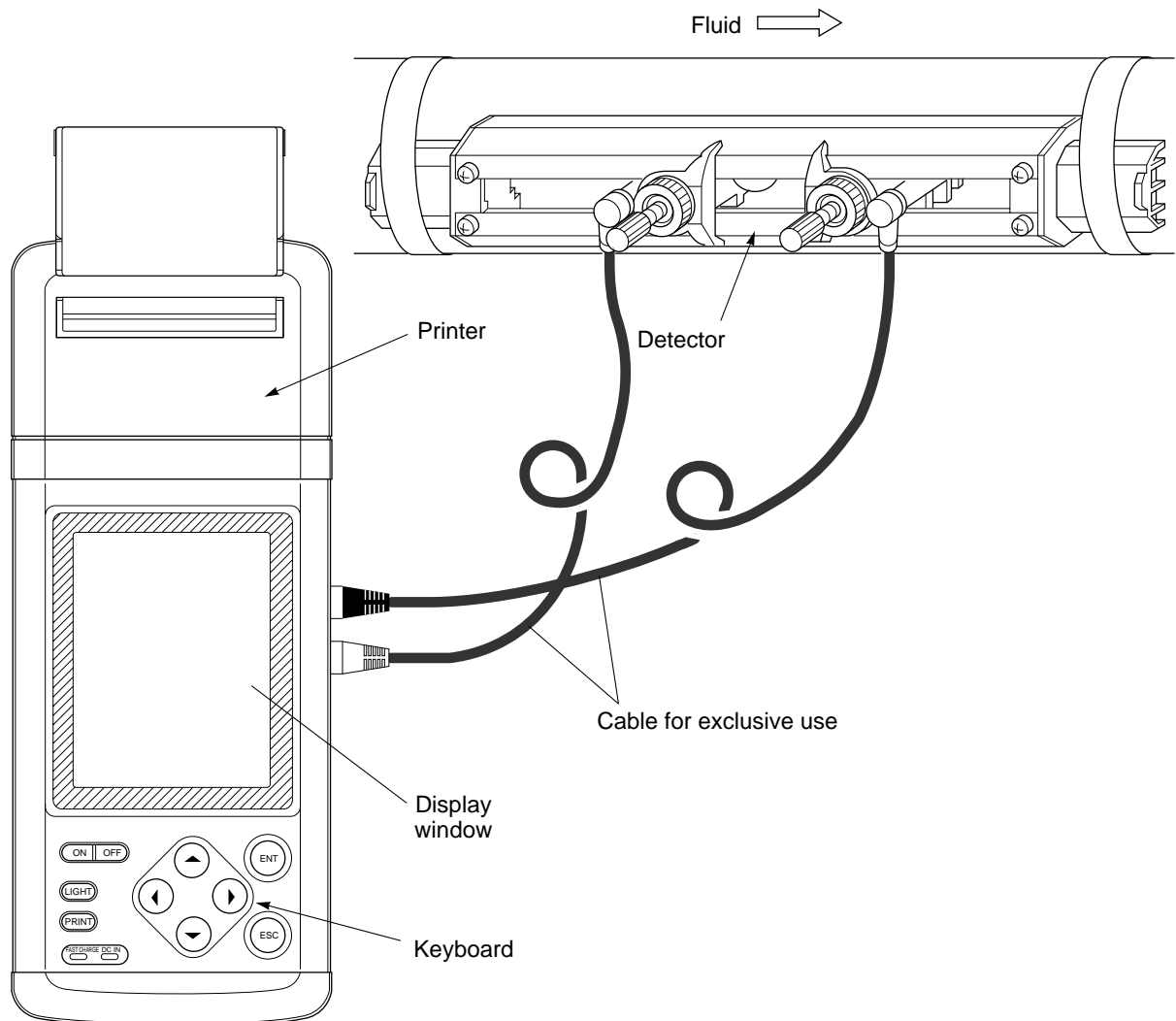

- **Keyboard** : Used for turning on/off power supply of the main unit, outputting a hard copy with the printer, inputting fluid specifications and setting the function of the meter.
- **Display window** : Displays measured value. Also used for display in data input or setting by keys. Because this is a large-size graphic LCD, indications are easier to read. Even at a dark place, indications can be read by using the backlight.
- **Printer (option)** : Capable of printing all information possessed by the PUX including the hard copy of display screen and printout of measured value. Meter comprises a logger function (for storing measured values in memory). After storing a few day's data in memory by the logger function, it can be printed.
- **Detector** : Attached to a pipe and receives/transmits ultrasonic wave.
- **Cable for exclusive use**: Used for transmitting to the instrument signals into which flow rates measured by the detector have been converted.

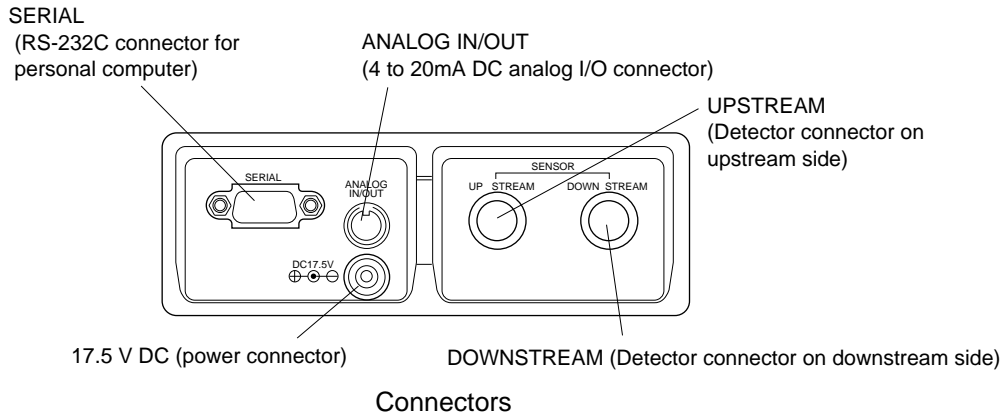

- **Connectors** : 17.5V DC
Connector of main unit power supply. Inputs 17.5V DC.
Insert the plug of the power adapter tailored for this instrument.
- : UP STREAM (upstream side), DOWN STREAM (downstream side)
These are connectors which receive sensor cords.
Connect matching the upstream and downstream sides.
- : ANALOG IN/OUT
Connect analog input/output signals (4 to 20mA DC).
- : SERIAL
Connector for serial transmission. Connect to an external system such as personal computer.

3.2 Explanation of keys

Fig. 3-1 shows the layout of keys and Table 3-1 explains each key.

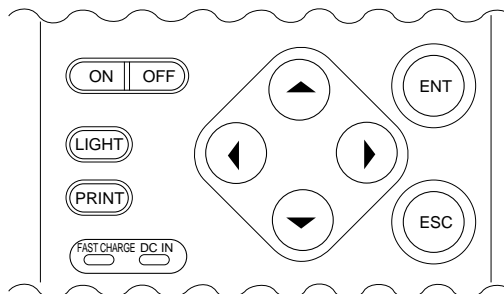

Fig. 3-1 Layout of keys

Table 3-1 Explanation of keys

Key indication lamp	Description
ENT	The keyed-in data, selected item, etc. will be set by pressing this key.
ESC	Cancels any setting.
▲	Moves the cursor upward, increments set value, etc.
▼	Moves the cursor downward, decrements set value, etc.
◀	Moves the cursor leftward, change scale, etc.
▶	Moves the cursor rightward, change scale, etc.
ON/OFF	Turns on/off power supply.
PRINT	Prints the screen display (outputs a hard copy).
LIGHT	Turns on/off the backlight of display screen.
FAST CHARGE	Turns ON in charge. Blinks in fully charged condition.
DC IN	Turns ON with power cable connected.

4. POWER UP

4.1 Operating power supply

There are two methods available for energizing this instrument; by the built-in battery or with the power adapter.

(1) Energizing with built-in battery

- ① To charge the battery
Turn OFF the instrument power and connect the AC power adapter. The “FAST CHARGE” LED is lighted in red, and “DC IN” LED is lighted in green.
When the instrument is fully charged, “FAST CHARGE” LED blinks in red.
* About 2 hours will be required for charging.
* In the fully charged condition, the instrument can measure for about 5 hours.
(On condition that the display backlight is turned off and the printer is unused.)

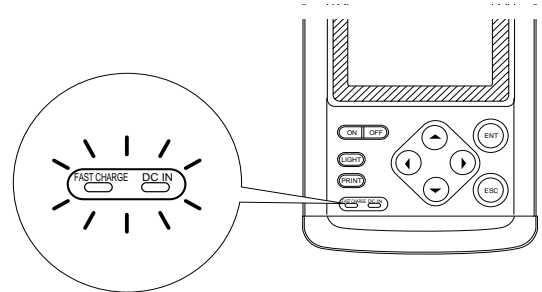

- ② To energize by built-in battery
When turning on the power supply without connecting the power adapter, the instrument will be energized by the built-in battery.
Before use, the battery should be fully charged.

(2) Energizing by power adapter



CAUTION

Use the exclusive power adapter only. Don't use other adapters, or it may result in an accident.

• AC power adapter

- ① Connect the output plug of AC power adapter to the 17.5V DC connector of main unit.
- ② Insert the input plug of this adapter into the power receptacle.
(This adapter has an input voltage range of 90 to 264V AC (at 50/60Hz).)

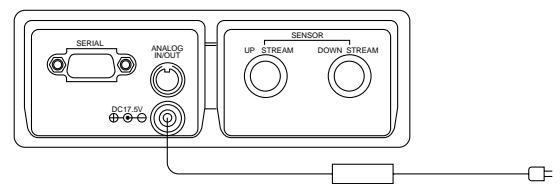

• DC power adapter

- ① Connect the output plug of DC power adapter to the 17.5V DC connector of main unit.
- ② Connect the input wires (+ and -) of DC power adapter to suitable DC power supply.
(This adapter has an input voltage range of 10 to 30V DC.)

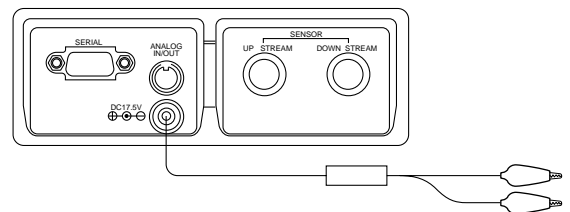

4.2 Turning on power supply

- ① Press the ON switch of the main unit to turn ON the power.

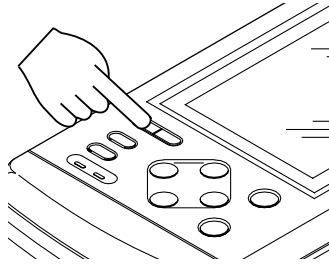

- ② Turn ON the power, and the following screen appears.

- ③ If there is nothing you can do on the screen for about 10 sec. the “MEASURE” screen appears.

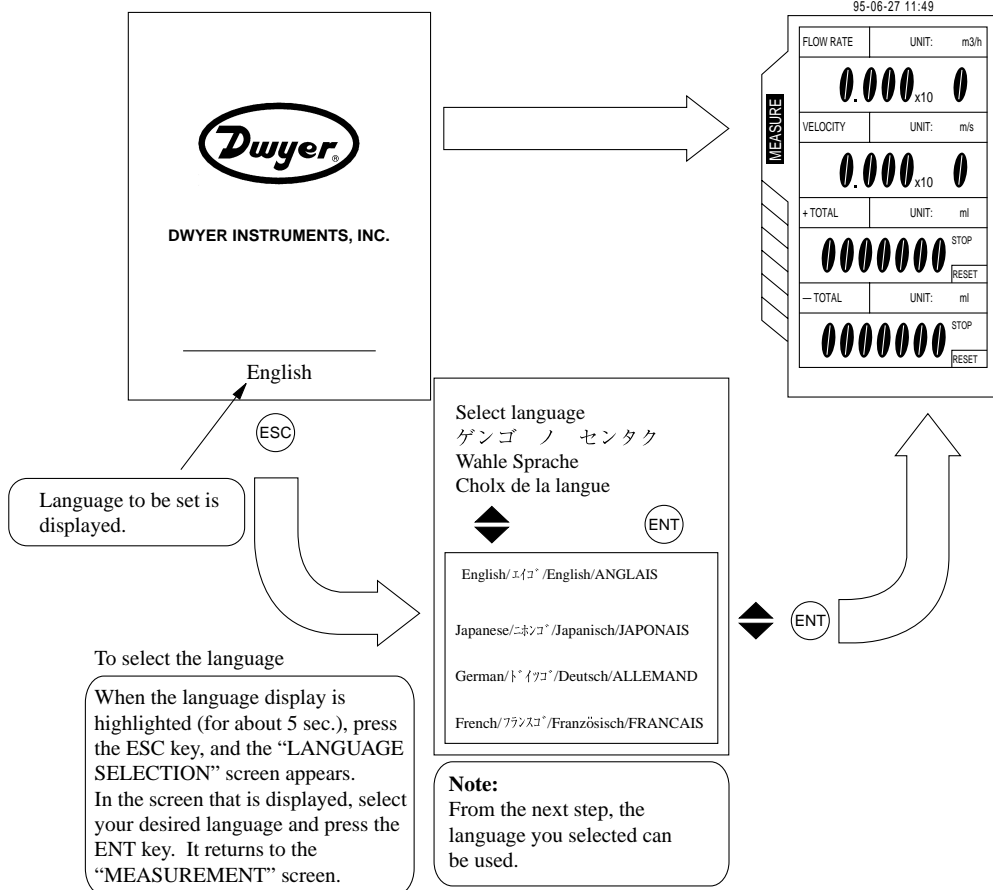

Note1) Select any of 4 languages: English, French, German, and Japanese (Katakana)

Note2) To return to the “LANGUAGE SELECTION” screen from the “MEASUREMENT” screen in display, turn OFF the power once and then turn it ON again. In the initial screen that is displayed, press the **ESC** key.

5. WIRING

5.1 Connection of dedicated cables

This cable is used for connecting the detector to the main unit.

- ① Connect dedicated cables to the upstream and downstream sides of the detector.
- ② Connect one cable connected to the upstream side of the detector to the “UP STREAM” connector of the main unit, and connect the other cable connected to the down stream side of the detector to the “DOWN STREAM” connector.

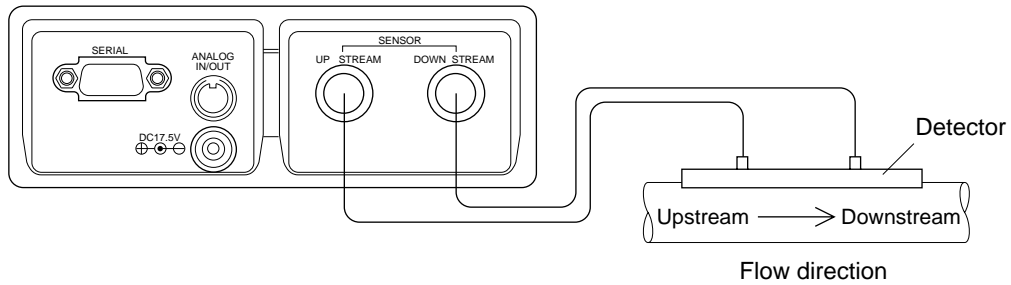

5.2 Connection of analog input/output cable (4 to 20 mA DC)

This cable is used for connection of receiving instruments (indicators, recorders, etc.) and the main unit. Analog I/O cable is connected as shown below. The cable end is treated with a clip.

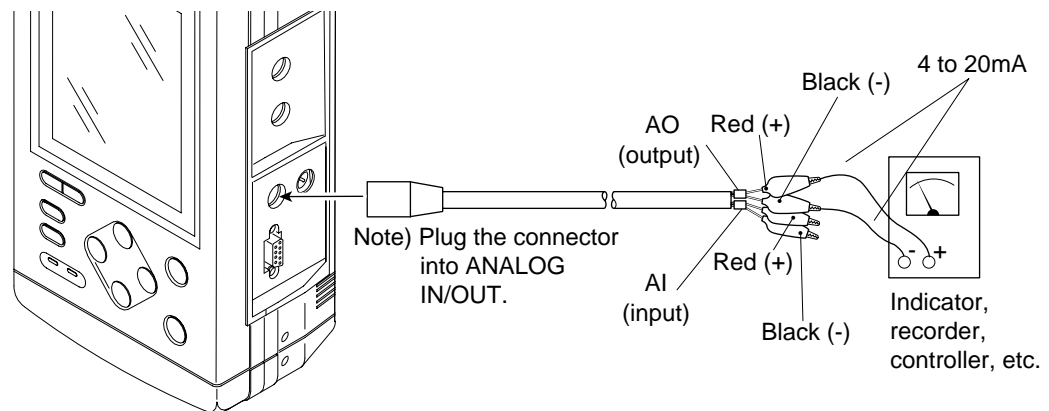

- ① Connect clips of the analog I/O cable to the (+) and (-) sides of the receiving instruments, respectively.
- ② Connect the analog I/O cable to the “ANALOG IN/OUT” connector at the side panel of the main unit.
Note) Allowable load resistance of analog output should be adjusted to 1 k Ω or less.
Input resistance of analog input is 100 Ω .

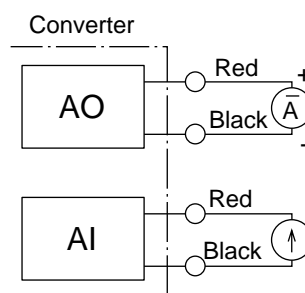

5.3 Connection of RS-232C cable

When using an optional personal computer, use RS-232C cable for serial transmission between the RS-232C connector of the personal computer and the “SERIAL” connector of the main unit. For PC software, refer to Chapter 12.

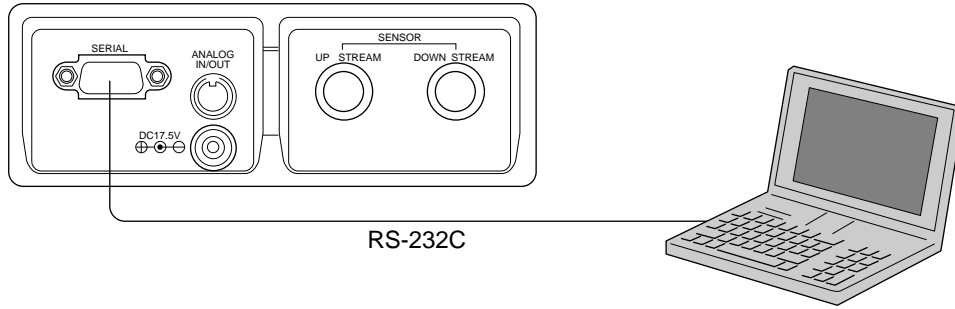

6. INPUT OF PIPING SPECIFICATIONS

Before installing the detector, set the specifications of a pipe in the main unit to allow measurements.



Caution) Measurements cannot be accomplished without these settings.

6.1 Display of pipe setup screen

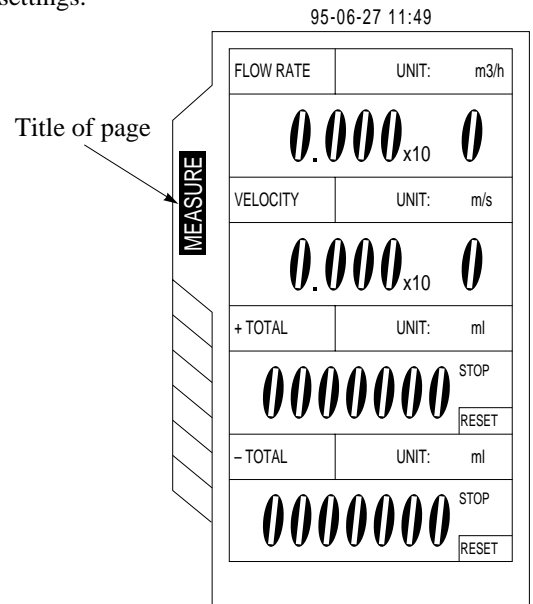
- Press the  key on the "MEASURE" screen to invert the "Tab".





- Press the  key, and the "SITE SETUP" menu screen is displayed.

To move the cursor on the screen, press the  key or  key.

To invert "PIPE PARAMETER" on the menu screen, press the  key on the "SITE SETUP" screen.

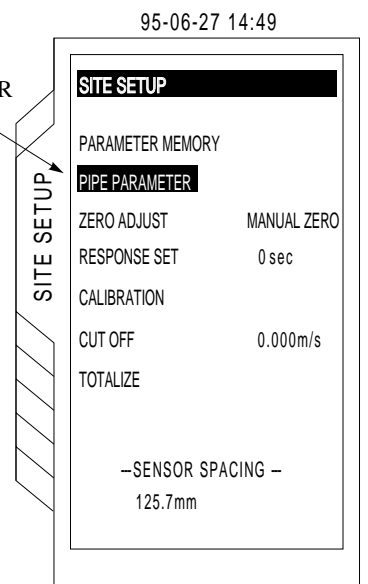
Invert the PIPE PARAMETER



- Press the  key, and "PIPE PARAMETER" screen is displayed.

PIPE PARAMETER screen is displayed.

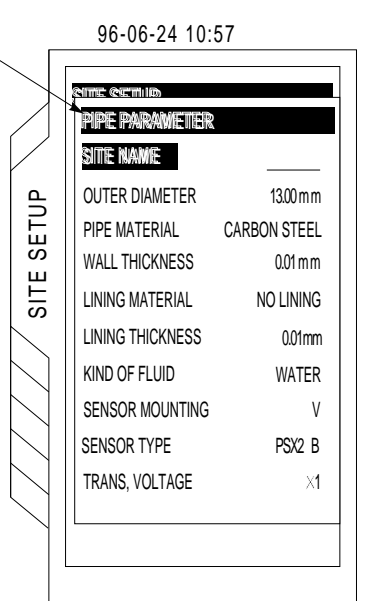

④ Outline of PIPE PARAMETER

96-06-24 10:57 ☺))

SITE SETUP			
PIPE PARAMETER			
SITE NAME		_____	Enter site name (name of pipe to be used for measurement) → Page 6 - 3
OUTER DIAMETER	13.00mm		Set external dimensions of pipe → Page 6 - 4
PIPE MATERIAL	CARBON STEEL		Set pipe material → Page 6 - 5
WALL THICKNESS	0.01mm		Set pipe thickness → Page 6 - 6
LINING MATERIAL	NO LINING		Set lining material → Page 6 - 7
LINING THICKNESS	0.01mm		Set lining thickness → Page 6 - 8
KIND OF FLUID	WATER		Set kind of fluid → Page 6 - 9
SENSOR MOUNTING	V		Set selection of sensor mounting method → Page 6 - 10
SENSOR TYPE	PSX2 B		Set type of sensor → Page 6 - 11
TRANS. VOLTAGE	x1		Set transmission voltage → Page 6 - 12

⑤ Display of mounting dimensions

When the settings are completed on the “PIPE PARAMETER” screen, press the (ESC) key to display the “SITE SETUP” menu screen.

At the last line the “SENSOR SPACING” value is displayed.

96-06-24 10:57

SITE SETUP		
PIPE PARAMETER		
SITE NAME		_____
OUTER DIAMETER	13.00mm	
PIPE MATERIAL	CARBON STEEL	
WALL THICKNESS	0.01mm	
LINING MATERIAL	NO LINING	
LINING THICKNESS	0.01mm	
KIND OF FLUID	WATER	
SENSOR MOUNTING	V	
SENSOR TYPE	PSX2 B	
TRANS. VOLTAGE	x1	

(ESC) →

95-06-27 14:49

SITE SETUP	
PARAMETER MEMORY	
PIPE PARAMETER	
ZERO ADJUST	MANUAL ZERO
RESPONSE SET	0 sec
CALIBRATION	
CUT OFF	0.000 m/s
TOTALIZE	
-SENSOR SPACING-	
125.7mm	

Mounting dimension

Install the sensor according to chapter 7. MOUNTING OF DETECTOR and the mounting dimension is as displayed on the last line.

6.2 Entry of site name (measurement is possible without entry)

Enter the name of the site (where measurement is performed). This name is registered with site memory (④ of page 6 - 2).

Select a character and press the **ENT** key. Characters will be displayed one by one at top of the screen. Then, select "CLOSE" and press the **ENT** key to complete entry (up to 20 characters can be entered). If you entered wrong characters, press the **ESC** key and characters can be cleared one by one.

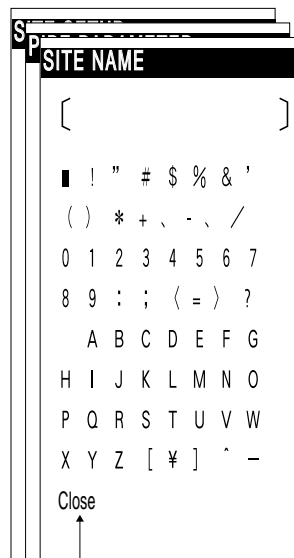

Select "CLOSE" and press the **ENT** key to complete entry.

PIPE NO.1 is selected from SITE NAME.

SITE SETUP	
PIPE PARAMETER	
SITE NAME	PIPE NO. 1
OUTER DIAMETER	13.00mm
PIPE MATERIAL	CARBON STEEL
WALL THICKNESS	0.01mm
LINING MATERIAL	NO LINING
LINING THICKNESS	0.01mm
KIND OF FLUID	WATER
SENSOR MOUNTING	V
SENSOR TYPE	PSX2B
TRANS. VOLTAGE	1TIME

6.3 Outer diameter of piping (unit: mm) (range: 13 to 6100 mm)

Press the key on the “PIPE PARAMETER” screen to invert the “OUTER DIAMETER”.

Press the key, and you can enter the outer dimension.

Use the or key to cause the digit to move in the right and left direction

Use the or key to enter the numeric.

After entry, press the key.

Note) Enter outer dimensions, but not nominal diameter (example: 20A → 20).

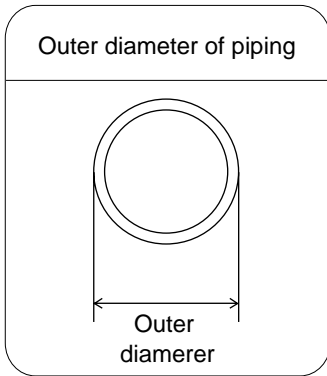

SITE SETUP

SITE SETUP	
PIPE PARAMETER	
SITE NAME	PIPE NO.1
OUTER DIAMETER	13.00 mm
PIPE MATERIAL	CARBON STEEL
WALL THICKNESS	0.01 mm
LINING MATERIAL	NO LINING
LINING THICKNESS	0.01 mm
KIND OF FLUID	WATER
SENSOR MOUNTING	V
SENSOR TYPE	PSX2 B
TRANS. VOLTAGE	4TIMES

SITE SETUP

SITE SETUP	
PIPE PARAMETER	
SITE NAME	
OUTER DIAMETER	0013.00 mm
PIPE MATERIAL	CARBON STEEL
WALL THICKNESS	0.01 mm
LINING MATERIAL	NO LINING
LINING THICKNESS	0.01 mm
KIND OF FLUID	WATER
SENSOR MOUNTING	V
SENSOR TYPE	PSX2 B
TRANS. VOLTAGE	4TIMES



Example) When the outer diameter of piping is 318.5 mm:

PIPE PARAMETER		PIPE PARAMETER	
SITE NAME		SITE NAME	
OUTER DIAMETER	0013.00 mm	OUTER DIAMETER	0318.50 mm

6.4 Piping material

Press the  key to invert the "PIPE MATERIAL".

Press the  key, and the "PIPE MATERIAL" screen will appear.

Select the material by using the  or  key. After entry, press the  key.

Note) If you select "OTHER", enter the sound velocity (range: 1000 to 3700m/s). See page 15 - 6, Table ②1.

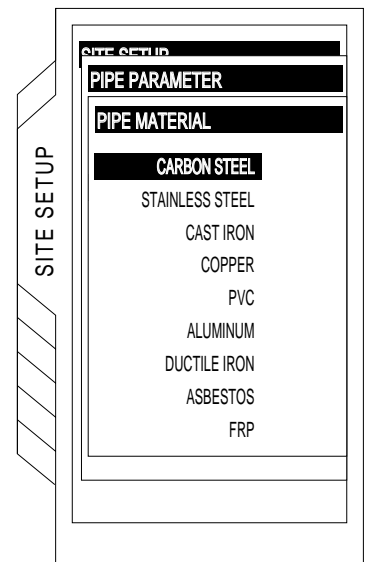
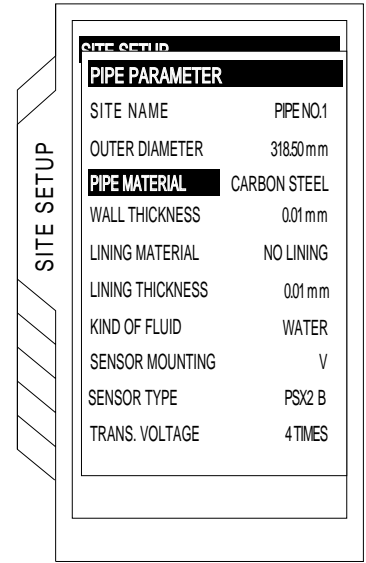

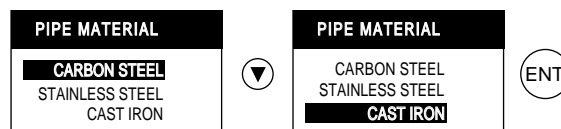

Example) When the piping material is cast iron:





6.5 Wall thickness (unit: mm) (range: 0.01 to 100.00mm)

Press the  key to invert the "WALL THICKNESS".

Press the  key, and wall thickness can be entered (See pages 15 -1 to 15 - 6, Piping Data).

Use the  or  key to move the digit to the right and left.

Using the  or  key, enter the numeral. After entry, press the  key.

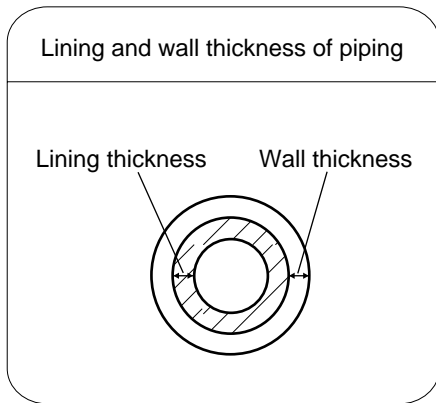

SITE SETUP	
PIPE PARAMETER	
SITE NAME	PIPENO.1
OUTER DIAMETER	318.50mm
PIPE MATERIAL	CARBON STEEL
WALL THICKNESS	0.01mm
LINING MATERIAL	NO LINING
LINING THICKNESS	0.01mm
KIND OF FLUID	WATER
SENSOR MOUNTING	V
SENSOR TYPE	PSX2 B
TRANS. VOLTAGE	4TIMES





SITE SETUP	
PIPE PARAMETER	
SITE NAME	
OUTER DIAMETER	318.50mm
PIPE MATERIAL	CARBON STEEL
WALL THICKNESS	0.01mm
LINING MATERIAL	NO LINING
LINING THICKNESS	0.01mm
KIND OF FLUID	WATER
SENSOR MOUNTING	V
SENSOR TYPE	PSX2B
TRANS. VOLTAGE	4TIMES





Example) When the wall thickness is 1.25mm

PIPE MATERIAL	CAST IRON		PIPE MATERIAL	CAST IRON	
WALL THICKNESS	000.01mm		WALL THICKNESS	001.25mm	
LINING MATERIAL	NO LINING		LINING MATERIAL	NO LINING	

6.6 Lining material

Press the  key to invert "LINING MATERIAL".
 Press the  key, and "LINING MATERIAL" screen will appear.

Using the  or  key, select the material. After selection, press the  key.

Note) If you select "OTHER", enter the sound velocity (range 1000 to 3700m/s). See page 15-6, Table ②.

SITE SETUP

SITE SETUP	
PIPE PARAMETER	
SITE NAME	PIPE NO.1
OUTER DIAMETER	318.50mm
PIPE MATERIAL	CAST IRON
WALL THICKNESS	1.25mm
LINING MATERIAL	
LINING MATERIAL	NO LINING
LINING THICKNESS	0.01mm
KIND OF FLUID	WATER
SENSOR MOUNTING	V
SENSOR TYPE	PSX2 B
TRANS. VOLTAGE	4TIMES





SITE SETUP

SITE SETUP	
PIPE PARAMETER	
LINING MATERIAL	
NO LINING	
TAR EPOXY	
MORTAR	
RUBBER	
TEFLON	
PYREX GLASS	
OTHER	2000 m/s

  

Example) When the lining material is mortar





LINING MATERIAL		LINING MATERIAL
NO LINING		NO LINING
TAR EPOXY		TAR EPOXY
MORTAR		MORTAR
ROBBER		ROBBER
		

6.7 Lining thickness (unit: mm) (range: 0.01 to 100.00 mm)

When the lining material is set to items other than “None” in 6.6 Lining material.

Press the  key to invert the “LINING THICKNESS”.

Press the  key, the lining thickness numeric entry can be performed.

The cursor can shift the numeric digit by using the  or  key. The numeric can be entered by using the  or  key.

After entry, press the  key.

SITE SETUP

SITE SETUP	
PIPE PARAMETER	
SITE NAME	PIPE NO.1
OUTER DIAMETER	318.50 mm
PIPE MATERIAL	CARBON STEEL
WALL THICKNESS	0.01 mm
LINING MATERIAL	NO LINING
LINING THICKNESS	0.01 mm
KIND OF FLUID	WATER
SENSOR MOUNTING	V
SENSOR TYPE	PSX2 B
TRANS. VOLTAGE	4 TIMES



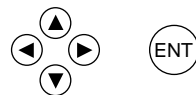

SITE SETUP

SITE SETUP	
PIPE PARAMETER	
SITE NAME	PIPE NO.1
OUTER DIAMETER	318.50 mm
PIPE MATERIAL	CARBON STEEL
WALL THICKNESS	0.01 mm
LINING MATERIAL	NO LINING
LINING THICKNESS	000.01 mm
KIND OF FLUID	WATER
SENSOR MOUNTING	V
SENSOR TYPE	PSX2 B
TRANS. VOLTAGE	4 TIMES



Example) When the lining thickness is 1.25 mm

LINING MATERIAL	MORTAR		LINING MATERIAL	MORTAR	
LINING THICKNESS	000.01 mm		LINING THICKNESS	001.25 mm	
KIND OF FLUID	WATER		KIND OF FLUID	WATER	

6.8 Kind of fluid

Select kind of fluid and enter the dynamic viscosity coefficient.

For fluid having no item, enter sound velocity.
(Range: 500 to 2500 m/s)

Press the \blacktriangledown key to invert the "KIND OF FLUID".

Press the ENT key. The "KIND OF FLUID" screen will appear.

Note 1) To return the screen to the "PIPE PARAMETER", press the ESC key.

Select kind of fluid by using the \blacktriangle or \blacktriangledown key.

After selection, press the ENT key, the screen will appear, to enter the dynamic viscosity coefficient.

The initial value is set to water coefficient.

CAUTION

There is no need to change "1.004 E-6m²/s" when measuring water. Return the screen by pressing the ESC key.

Note 2) When "OTHER" is selected, enter sound velocity. See page 15-6, Tables 20 and 22.

Remarks

Dynamic viscosity coefficient is set to water (20°C).
When measuring accurately or measuring fluid other than water, enter as needed.

(See page 15-6.)

(Range: 0.001×10^{-6} to $999.999 \times 10^{-6} \text{m}^2/\text{s}$)

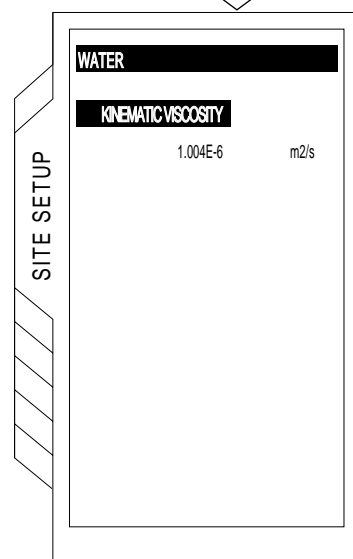
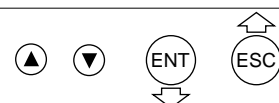
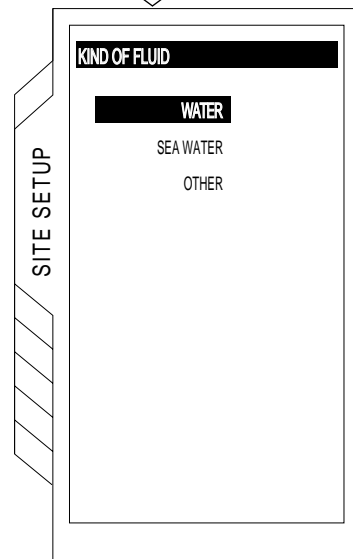
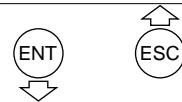
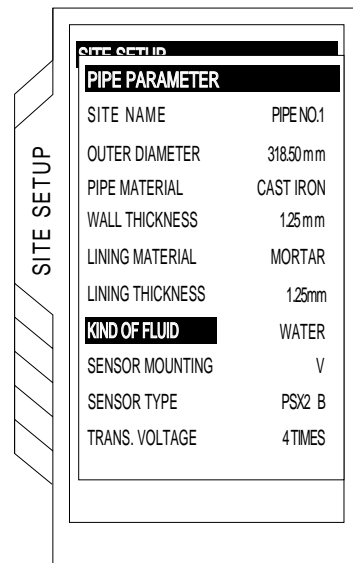
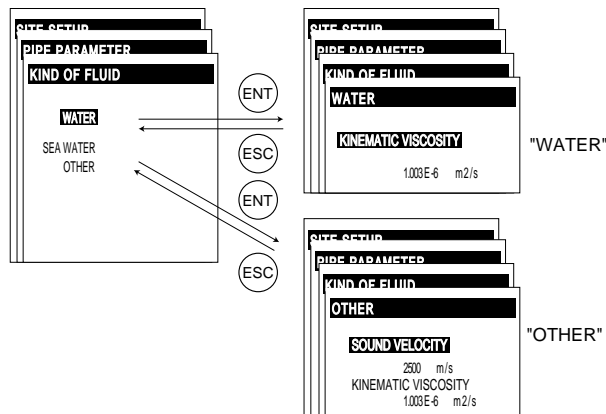

6.9 Selection of sensor mounting method

Mounting methods available for the sensor are V method and Z method as illustrated.

To select the mounting method;

Press the  key to invert the "SENSOR MOUNTING".

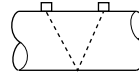

Press the  key. The "SENSOR MOUNTING" screen will appear.

V method

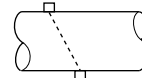

Z method



Select either V or Z method using the  or  key.

Remarks

Select the V method generally. Use the Z method in the following cases:

- Ample space is not provided.
- High turbidity
- Weak receiving waveform
- Thick scale is deposited on the pipe internal surface.

SITE SETUP	
PIPE PARAMETER	
SITE NAME	PIPENO.1
OUTER DIAMETER	318.50mm
PIPE MATERIAL	CAST IRON
WALL THICKNESS	1.25mm
LINING MATERIAL	MORTAR
LINING THICKNESS	1.25mm
KIND OF FLUID	WATER
SENSOR MOUNTING	V
SENSOR TYPE	PSX2 B
TRANS. VOLTAGE	4TIMES



SITE SETUP	
PIPE PARAMETER	
SENSOR MOUNTING	
V	
Z	



  

6.10 Kind of sensor

Press the  key to invert "SENSOR TYPE".

Press the  key to display kind of sensor.

Select any sensor from the type code of sensor to be used.

Select the sensor by using the  or  key.

SITE SETUP

SITE SETUP	
PIPE PARAMETER	
SITE NAME	PIPE NO.1
OUTER DIAMETER	318.50mm
PIPE MATERIAL	CAST IRON
WALL THICKNESS	1.25mm
LINING MATERIAL	MORTAR
LINING THICKNESS	1.25mm
KIND OF FLUID	WATER
SENSOR MOUNTING	V
SENSOR TYPE	PSX2 B
TRANS. VOLTAGE	4TIMES



SITE SETUP



SITE SETUP	
PIPE PARAMETER	
SENSOR TYPE	
	PSX2 E
	PSX2 A
	PSX2 B
	PSX2 HT
	PSX2 C/SX1 B
	SX1 C
	PSX2 D











Example) When model of sensor is PSX2 A

SENSOR TYPE		SENSOR TYPE	
PSX2 E		PSX2 E	
PSX2 A		PSX2 A	
PSX2 B		PSX2 B	

6.11 Transmission voltage (used when an indicator is 1 or less during measurement)

Press the  key to invert the “TRANS. VOLTAGE”.
 Press the  key. The screen is ready to allow the selection of the transmission voltage level.
 Use the  or  key to select the level.
 Select “4 TIMES” or “8 TIMES” generally.

CAUTION

If the indicator cannot be set to 2 or more with the level at “8 TIMES”, ultrasonic wave may be attenuated due to contamination or scales deposited on the piping external and internal surfaces. Change measurement location.

Example) When transmission voltage is set to eight-fold

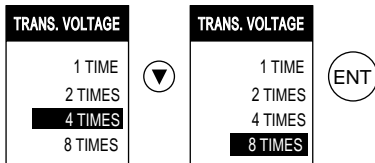

The indicator will be updated on the “MEASURE” screen only.

If less than 2 indicators (intensity of receiving waveform) are displayed on the “MEASURE” screen, raise the transmission voltage.

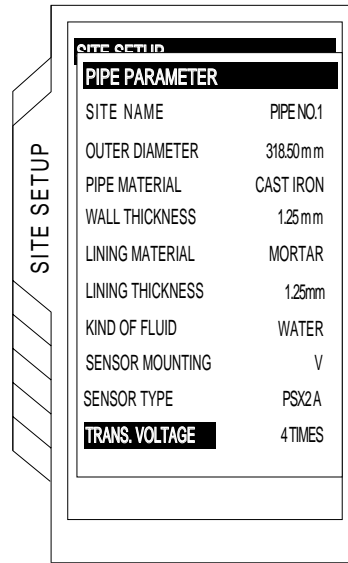



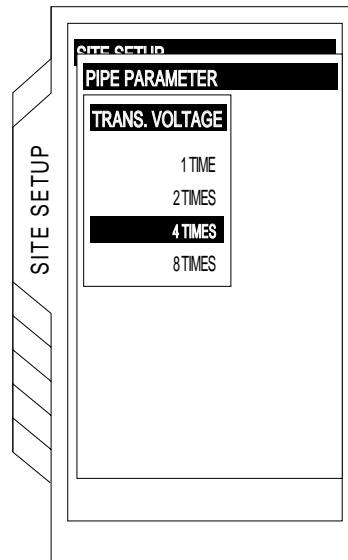

Indicator

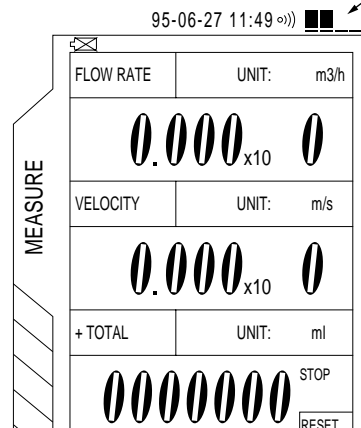

7. MOUNTING OF DETECTOR

7.1 Selection of mounting location

Detector mounting location, i.e., the conditions of the pipe subjected to flow rate measurement exert a great influence on measurement accuracy. So select a location meeting the conditions listed below.

- (1) There is a straight pipe portion of 10D or more on the upstream side and that of 5D or more on the downstream side.
- (2) No factors to disturb the flow (such as pump and valve) within about 30D on the upstream side.

Classification	For upstream side	For downstream side
90° bend		
Tee		
Diffuser		
Reducer		
Valves		
Pump		

Extracted from Japan Electric and Machinery Industry Society (JEMIS-032)

- (3) Pipe is always filled with fluid. Neither air bubbles nor foreign materials are contained in the fluid.
- (4) There is an ample maintenance space around the pipe to which the detector is to be mounted (see figure below).

Note 1) Secure an adequate space for allowing a person to stand and work on both sides of a pipe.
 Note 2) D indicates the inside diameter of a pipe.

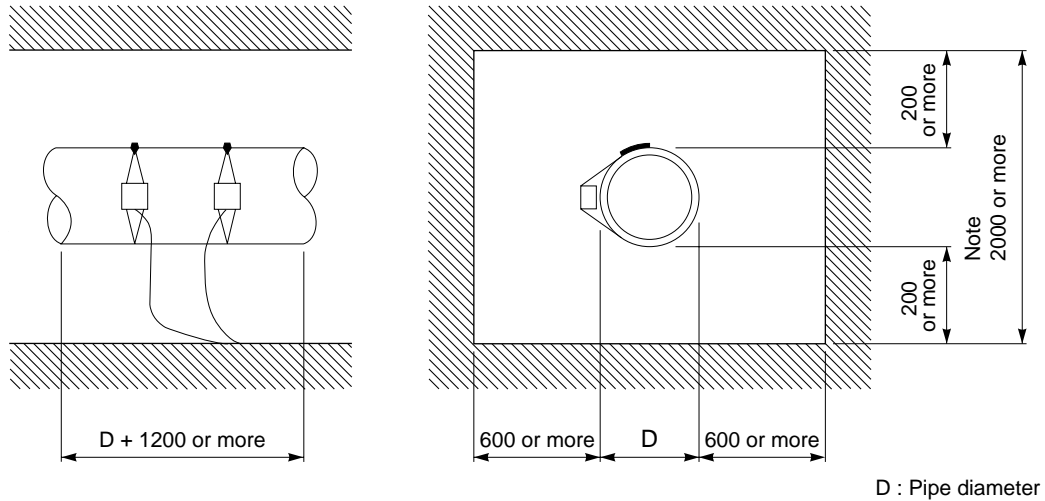

Space required for mounting detector

- (5) For a horizontal pipe, mount the detector within $\pm 45^\circ$ of the horizontal plane.
 For a vertical pipe, the detector can be mounted at any position on the outer circumference.

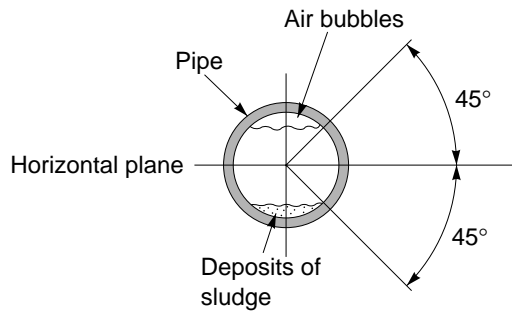

- (6) Avoid mounting the detector near a deformation, flange or welded part on the pipe.

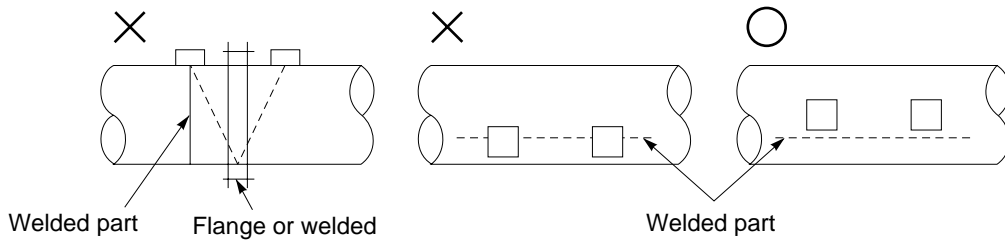

7.2 Selection of detector

(1) Selection of mounting methods

There are 2 methods for mounting the detector; V method and Z method. For the mounting space, see the following sketch.

<Large sensor>

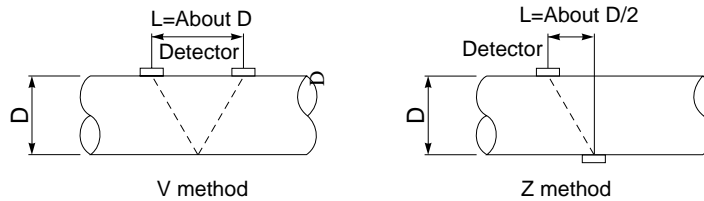

<Small diameter sensor, small sensor or high-temperature sensor>

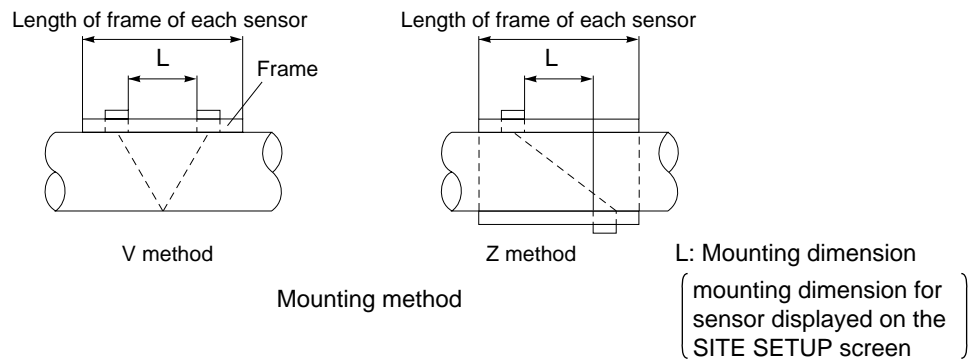

Employ the Z method in the following cases.

- Mounting space need be saved (mounting space of the Z method is about one half of the V method's).
- Turbid fluid such as sewage is to be measured.
- Pipe has mortar lining.
- A thick film of scale may have been formed on the inner surface of pipe because it is old.

(2) Detector selection standards

The Z method for large size sensor is recommended for outer diameter 300mm or more.

PSX2 D should be used as much as possible for pipes such as old pipes, cast iron pipes, and mortar lining pipes, through which it is difficult for ultrasonic signals to pass.

Detector

Type	Diameter	Temperature
PSX2 B	13 [] 100mm (V method)	-4 [] +100°C
PSX2 A/E	50 [] 350mm (V method)	-40 [] +100°C
	300 [] 400mm (Z method)	
PSX2 HT	50 [] 350mm (V method)	-40 [] +200°C
	300 [] 400mm (Z method)	
PSX2 D	200 [] 3000mm (V method)	-40 [] +80°C
	200 [] 6000mm (Z method)	

7.3 Use of surface-treated accessories

Eliminate pitting, corrosion, unevenness, etc. with paint thinner and sandpaper from the pipe portion where the detector is to be mounted.

Note) In case jute is wound on a pipe, it should be peeled off before the above treatment.
 When cast iron pipe is used, grind the sensor mounting surface by using a sander for smoothness.

Detector	Width
Small outer diameter PSX2B	320 mm or more
Small size (standard) sensor PSX2A	540 mm or more
Large size sensor PSX2D	Mounting dimension (L) + 200 mm or more
High temperature PSX2 HT	530 mm or more

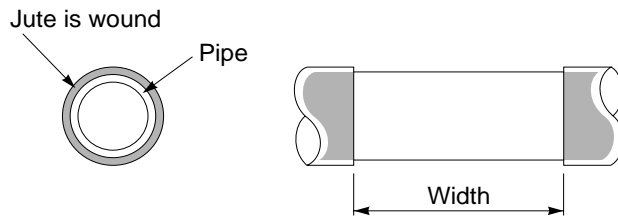

7.4 How to mount small size (standard) sensor and small outer diameter sensor to pipe

- ① Loosen the lock nut and slide the sensor so as to meet the mounting dimension and then tighten the nut.

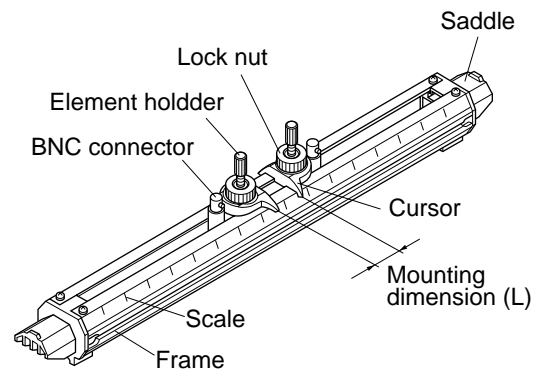

- ② Apply a coat of silicone grease to the transmitting surface of the sensor. Spread the compound over the entire area.

Keep the sensor retracted by turning the element holder counterclockwise.

After cleaning the surface of the pipe, the sensor should be mounted.

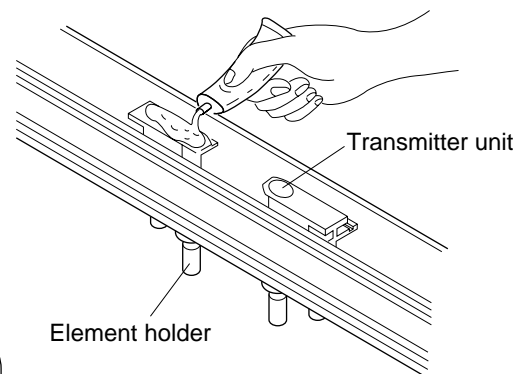

CAUTION

Apply a small quantity (like toothpaste) of silicon grease to the transmitter unit.

- ③ Fix the both ends (saddles) of the sensor to the pipe by cloth belts. Mounting will be facilitated by winding the cloth belts on the pipe in advance. Cloth belts are usable at 80°C or lower. If beyond 80°C, stainless steel belts should be used.

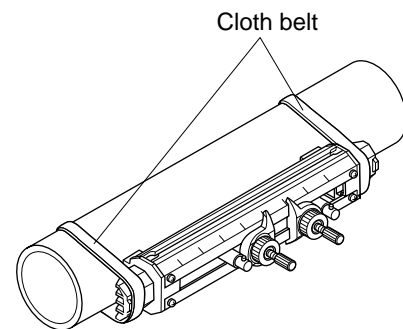

- ④ Make sure the sensor is mounted in parallel with the pipe axis and the mounting dimension is right. Then, turn the element holder clockwise until the sensor comes in close contact with the pipe.

Stop turning the element holder when it stiffens because the transmitting surface comes in contact with the pipe surface. Be careful not to turn the holder excessively.

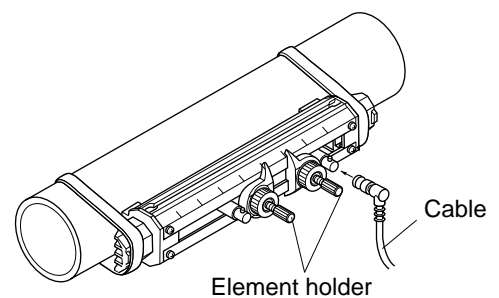

7.5 How to mount large size sensor

7.5.1 How to determine mounting position (large sensor)

Determine the mounting position by carrying out the following work.

For this work, gauge paper is necessary (For the gauge paper, refer to page 7-10).

- ① Match the edge of gauge paper with the line at about 100mm from one end of the pipe portion treated for detector mounting, and wind the gauge paper so that the line marked on the paper is parallel with the pipe axis (fix with tape not to allow deviation). At this time, the edge of gauge paper should be aligned.

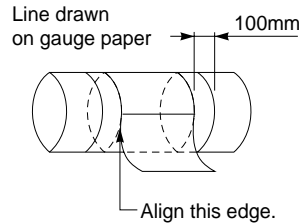

- ② Extending the line marked on the gauge paper, mark straight line A on the pipe.

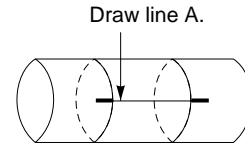

- ③ Mark a line along on edge of the gauge paper. The intersection of this line and straight line A is replaced with A_0 .

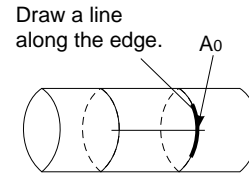

- ④ In mounting by the V method, peel the gauge paper and measure the mounting dimension from A_0 to determine A_2 position. At this position, mark a line orthogonal to the straight line A.

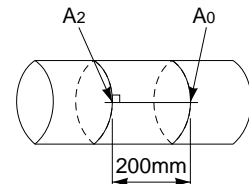

A_0 and A_2 become the mounting positions.

Example) $L = 200\text{mm}$

- ⑤ In mounting by the Z method, measure the circumference from A_0 with a measuring tape. At 1/2 of the circumference, determine points B_0 and B_1 , and mark a line (straight line B) connecting those points.

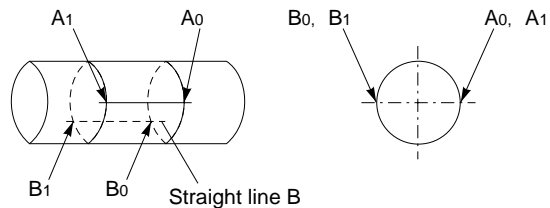

- ⑥ Mark the points B_0 and peel off the gauge paper. Measure the mounting dimension from B_0 to determine B_2 position. At this position, make a line orthogonal to the straight line B.

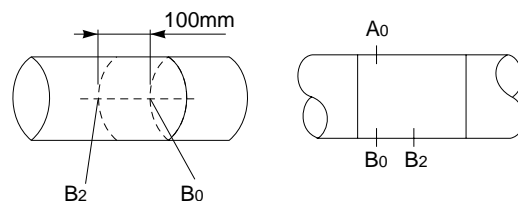

A_0 and B_2 become the mounting positions.

Example) $L = 100\text{mm}$

7.5.2 How to connect large size sensor for PSX2 D type only

- ① Slide the detector cover slightly. Remove the cover with a driver.

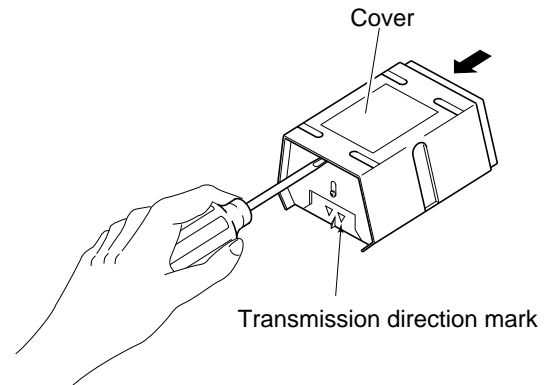

- ② Determine the mounting posture of sensor on the pipe.
Align the transmission direction marks.

Align the transmission direction marks.

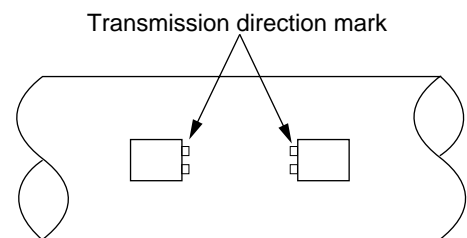

- ③ Put a mark on the inlet of coaxial cable.

When the pipe is horizontally installed with the detector, allow the coaxial cable to be suspended to prevent entry of water from the cable inlet.

When the pipe installed vertically, it does not matter how the coaxial cable should be installed.

Note) Upstream and downstream sensors should be able to be distinguished.

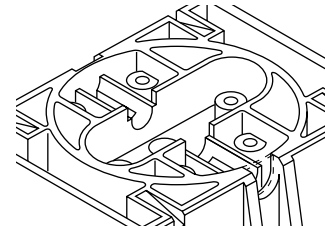

- ④ Connect the coaxial cable to terminal (G, +) and fix it with the cable clamp.

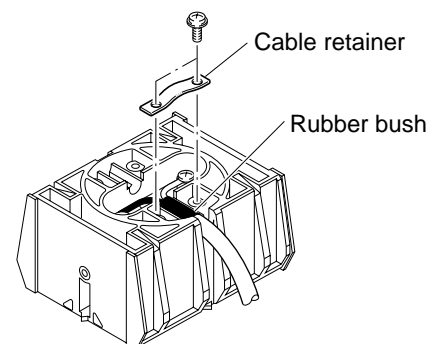

- ⑤ Replace the cover.

7.5.3 How to mount large size sensor to pipe

① Height adjustment of guide plate

- Place the sensor on the pipe surface in parallel with the pipe axis.
- Loosen the guide plate fixing screw and slide the guide plate until its edge and transmitting surface touch the surface of pipe.
- Then tighten the fixing screw.

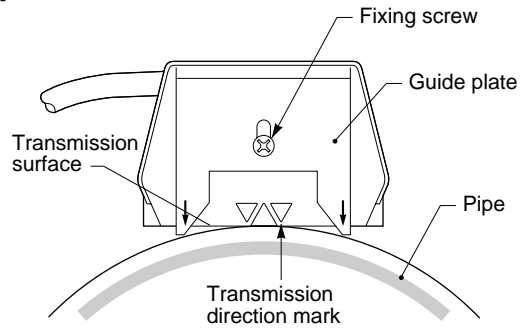

② How to determine the length of wire rope

- Place the sensor on the marked lines and fit the wire rope and fastening spring.
- Loosen the wire clip and pull the wire rope until the overall length of fastening spring approximates 180mm. Then tighten the wire clip. (The fastening spring has a free length of 110mm.)
- While fixing the wire rope, remove the sensor.

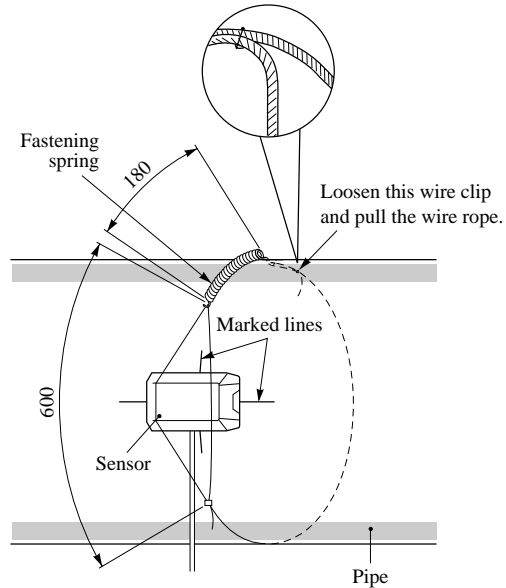

③ Mounting of sensor

- Wipe off contaminants from the transmitting surface of sensor and the sensor mounting surface of pipe.
- Apply the silicone grease on the transmitting surface of sensor while spreading it evenly.
- Film thickness of the silicone grease should be about 3mm.
- Spread the wire rope near the marked lines in the left-right direction, bring the sensor in close contact and fit the wire rope.
- Align the matching mark of sensor with the marked line. In addition, make the transmitting direction marks of sensors face each other.
- Make sure the matching mark of sensor is aligned with the marked line and connect the coaxial cable to the converter.

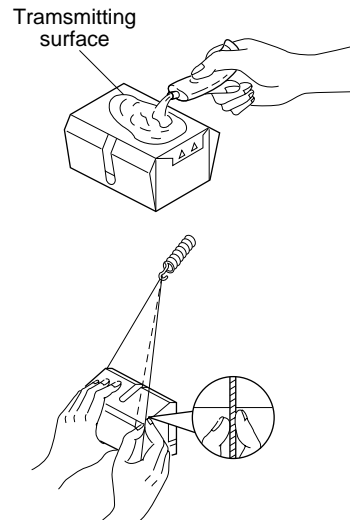

Note) Do not pull the coaxial cable. Otherwise, the sensor will be activated to disturb measurement.

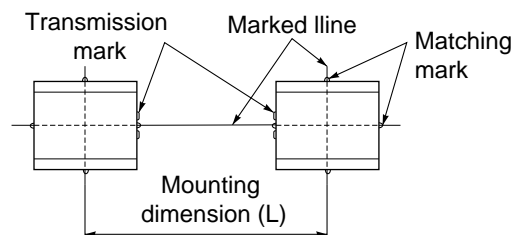
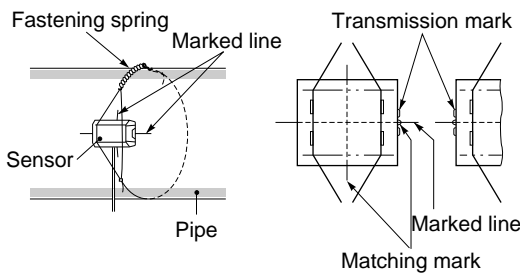

7.6 How to mount high temperature sensor to pipe

- ① Loosen the lock nut and slide the sensor so as to meet the mounting dimension and then tighten the nut.

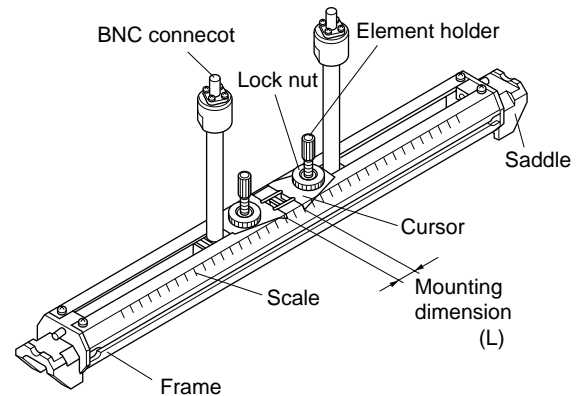

- ② Apply a coat of grease for high temperature to the transmitting surface of the sensor. Spread the compound over the entire area. Keep the sensor retracted by turning the element holder counterclockwise. After cleaning the surface of the pipe, the sensor should be mounted.

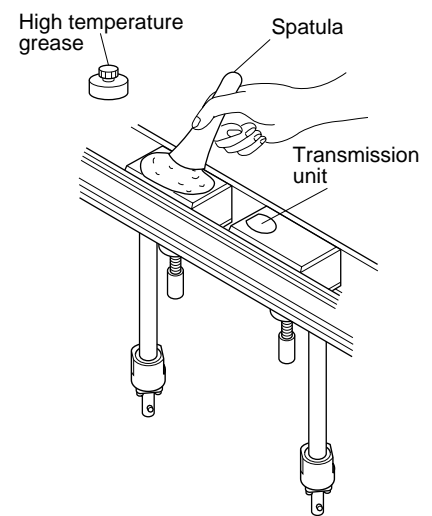

- ③ Fix the both ends (saddles) of the sensor to the pipe by stainless belts.

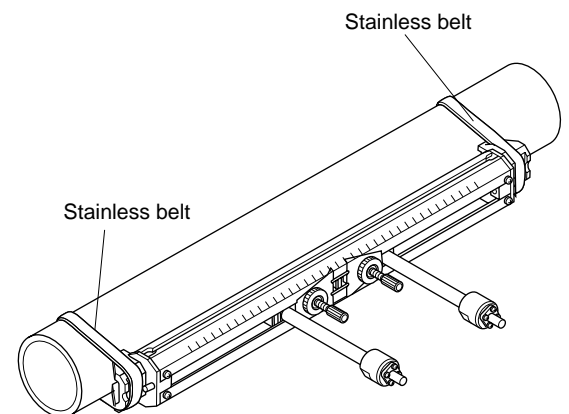

- ④ Make sure the sensor is mounted in parallel with the pipe axis and the mounting dimension is right. Then, turn the element holder clockwise until the sensor comes in close contact with the pipe.

Stop turning the element holder when it stiffens because the transmitting surface comes in contact with the pipe surface. Be careful not to turn the holder excessively.

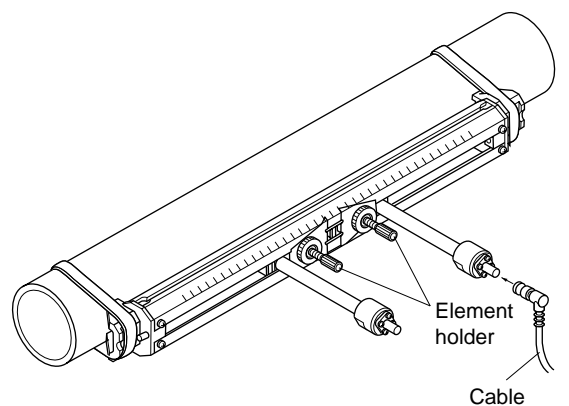

7.7 How to mount medium diameter sensor to pipe

- ① Spread silicone grease over the whole transmitting side of the sensor. Care should be taken to prevent entry of air bubbles.

Clean the surface of the pipe, then mount the sensor.

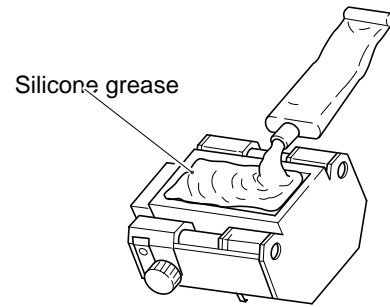

- ② Press the sensor against the pipe. Align the center of the sensor with the intersection of the marking line, and the mounting dimension reference surface with the marking line.

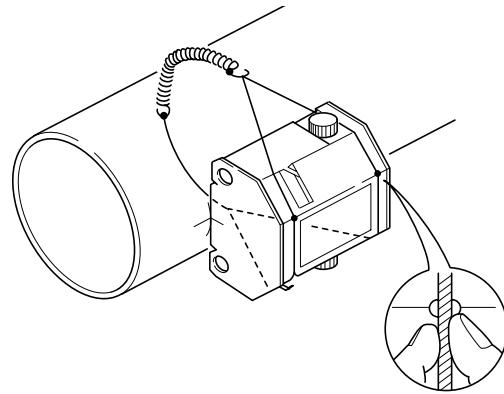

- ③ Make sure that the center mark on the sensor is aligned with the marking line. Then, connect the coaxial cable to the transmitter.

Note) Do not pull the coaxial cable. If it is pulled, the sensor is shifted which results in incorrect measurements due to poor contact with the pipe.

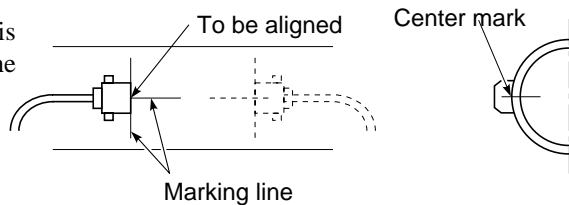

7.8 How to fold gauge paper (used for determining mounting position)

- ① Prepare a sheet of paper (vinyl sheet) of $4D$ or more in length and 200 mm or longer in width (D is preferable) as shown below.
- ② Draw a line intersecting at right angles with the longest sides about 100 mm from one paper end.

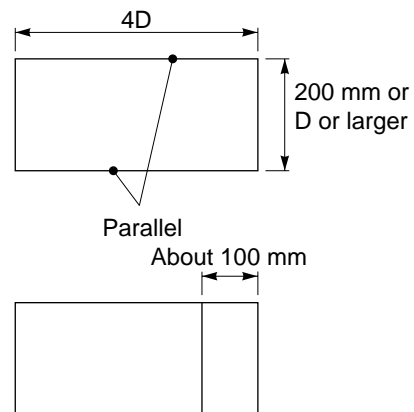

8. MEASUREMENT

When wiring, piping settings and mounting of the sensor are completed, start the measurement.
The contents displayed on the MEASURE screen are as follows.

Instantaneous flow meter

- On the MEASURE screen, instantaneous flow, instantaneous flow velocity, analog output, and analog input are displayed.
- Of the 4 stages displayed on the MEASURE screen, 2 contents can be arbitrarily allocated to the 1st and 2nd stage. Allocation is accomplished by selection of "UNIT".
- If the flow rate is displayed when water flow stops, refer to page 9-3, "ZERO ADJUST" and page 9-5, "CUT OFF".
- If the flow display fluctuates, refer to page 9-3 "RESPONSE SET".

Integrated flow rate

- When the integrated flow rate is displayed, "+TOTAL" and "-TOTAL" are fixed on the third stage and 4th stage, respectively.
- Integrated flow rate value is available in the range from 0000000 to 999999. If the value exceeds 9999999, it resets to 0000000.

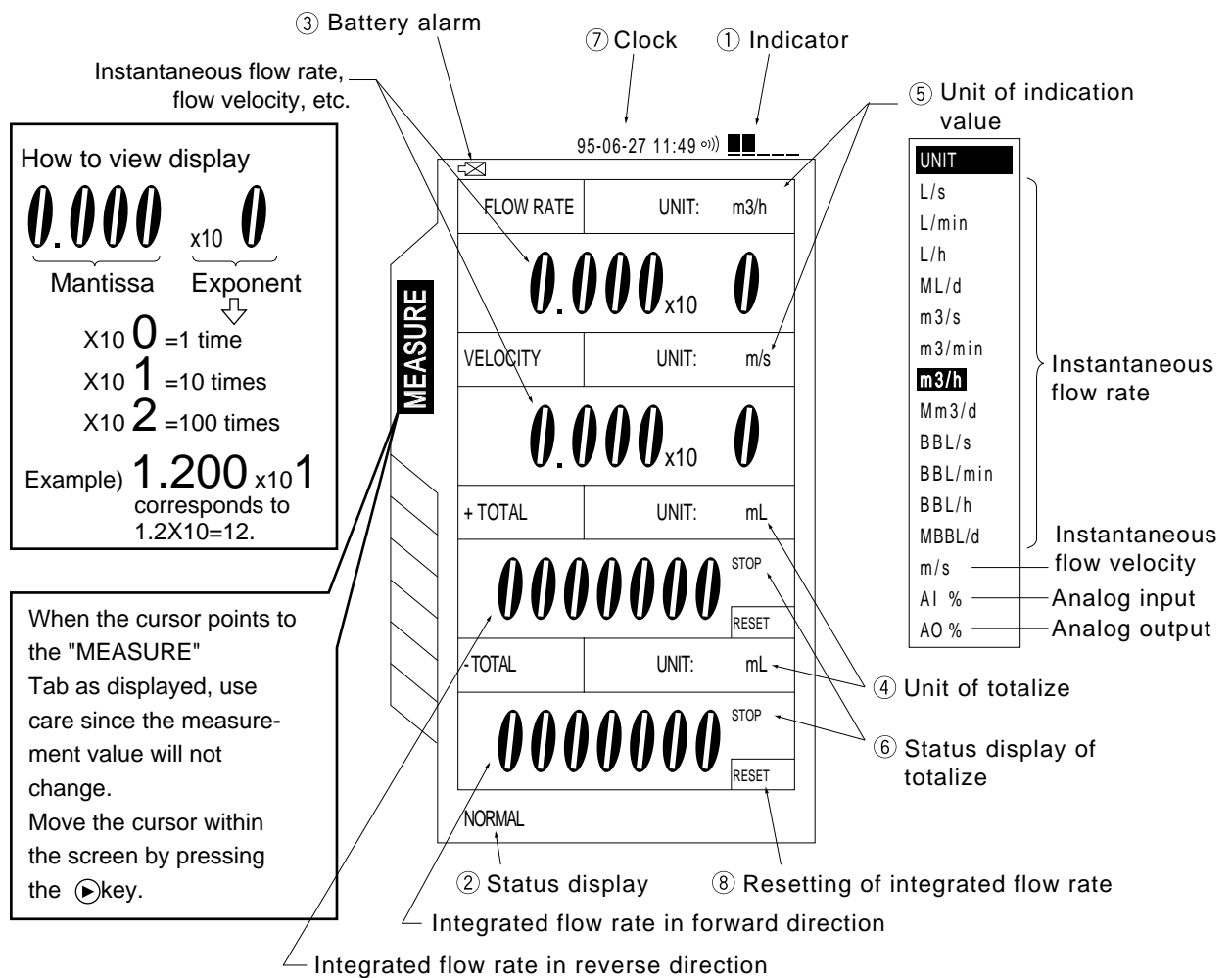

① “Indicator”

Shows the intensity of ultrasonic receiving signal.
Check if 2 or more indicators are displayed.

If one or less indicator is displayed, raise the transmission voltage level as shown on page 6-12.

When the sensor is not connected, the indicator may be lighted by sensing noises. But, this is not an error.

② “Status display”

Check if “NORMAL” is displayed. If the sensor is not connected, other messages may be displayed. This is not an error.

In case other message is displayed after installing and connecting the sensor, take corrective actions according to page 9-33, “System check function”.

If “NORMAL” is not displayed when 1 or less indicator is display, refer to page 11-2, “Error in measured value”.

③ “Battery alarm”

When activating this instrument on the built-in battery, check if the BATTERY ALARM () is not displayed. If “BATTERY ALARM” is displayed, the power is turned OFF in about 20 minutes.

When charging the battery, refer to page 4-1 “To charge the battery”.

④ Unit of integration

When changing the unit of integration, refer to page 9-6, “TOTALIZE: when performing the integration process of measured data (totalize)”.

⑤ Unit of indication value

To change the units of flow rate and flow velocity on the MEASURE screen;

- ① Move the cursor to “UNIT” by pressing the \blacktriangle or \blacktriangledown key.
- ② Press the ENT key, and the screen appears, enabling the unit of flow rate to be selected. Select any unit by pressing the \blacktriangle or \blacktriangledown key and press the ENT key.

Point the cursor to UNIT of flow rate and press the ENT key, and Menu screen is displayed.

⑥ Status display of integration

Meaning of display

- STOP: Not totalized
- RUN: Totalizing in progress

To start the action of integration, refer to page 9-6, “TOTALIZE”.

⑦ “Clock set”

This instrument has a timer function. For the timer to set the time, refer to page 9-15, “CLOCK SET”.

The timer function should be used based on this watch.

⑧ Reset

The integration value can be set to 0 or “any other numeric value”. To reset the integration value, point the cursor to “RESET” by pressing the \blacktriangle or \blacktriangledown key, and then press the ENT key. When you want to reset to any value or 1000 for example, refer to page 9-7, “To set reset data”.

Point the cursor to RESET and press the ENT key, and totalize is reset.

9. SETTING OPERATION (APPLICATION)

This section describes an outline and page configuration of each function page

SITE SETUP

Condition settings for measurement

SITE SETUP	
PARAMETER MEMORY	
PIPE PARAMETER	
ZERO ADJUST	MANUAL ZERO
RESPONSE SET	0 sec
CALIBRATION	
CUT OFF	0.000 m/s
TOTALIZE	
-SENSOR SPACING -	
126.7mm	

ANALOG

Settings of analog input and output

ANALOG IN /OUT	
INPUT	
DISPLAY	
INPUT RANGE	0.000E0
ADJUST	
OUTPUT	
DISPLAY	
RANGE UNIT	ms
OUTPUT RANGE	1.000E0
OUTPUT MODE	0.8-4-20mA
BURN-OUT	HOLD
ADJUST	

LOGGER

Saving of measured value to memory, and display and output of data

MODE		REMAIN	
SETUP		255	BLOCK

No	LOG NAME	DATA
1		✓
2	Flow Site	
3	**EMPTY**	
4	**EMPTY**	
5	**EMPTY**	
6	**EMPTY**	
7	**EMPTY**	
8	**EMPTY**	
9	**EMPTY**	
10	**EMPTY**	

PRINTER

Various outputs on printer

MODE	
TEXT	

UNIT	FLOW RATE	VELOCITY	OFF
			OFF
		+ TOTAL	OFF
		- TOTAL	OFF
		ANALOG IN	OFF

TIMER MODE	TIMER

SAMPLING PERIOD	
	00:00:01

PRINT OUT

SYSTEM SETUP

Change of basic system settings of main unit

SYSTEM SETUP	
CLOCK SET 95-06-25 15:17:00	
COMMUNICATION	
BAUD RATE	300
PARITY	NONE
STOP BIT	1 BIT
SYSTEM OF UNITS	METRIC
MEASUREMENT METHOD	1
MEMORY INITIALIZE	

SYSTEM CHECK

Check function of device status

SYSTEM CHECK	
ERROR CHECK	
SIGNAL CHECK	
OUTPUT CHECK	0.00%
VERSION NUMBER	

9.1 How to use SITE SETUP function (SITE SETUP page)

9.1.1 PARAMETER MEMORY: when registering data which are set and calibrated on the page

“PARAMETER MEMORY” allows you to register data which are set and calibrated on the “SITE SETUP” page to the memory of the main unit.
 When measurements are performed in the same pipe, registered data can be loaded to help you in achieving measurements. (Up to 20 registrations of data can be made to the memory.)

[Operation]

- ① Select “PARAMETER MEMORY” by pressing the ▲ or ▼ key on the SITE SETUP page.

Press the ENT key, and the “PARAMETER MEMORY” screen is displayed. To return to the “SITE SETUP” screen, press the ESC key.

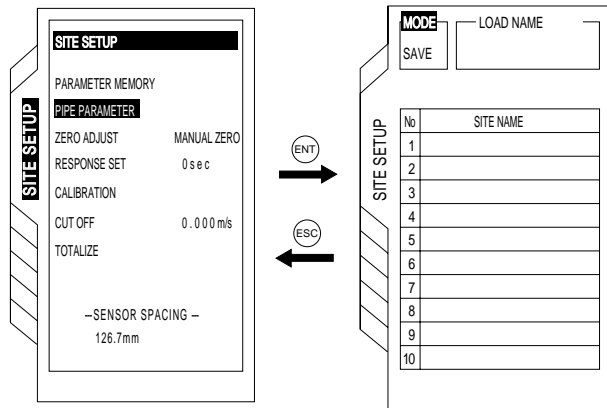

- ② Move the cursor to “MODE” and press the ENT key. The mode selection screen will appear. When pressing the ENT key after mode selection, the relevant mode is determined.

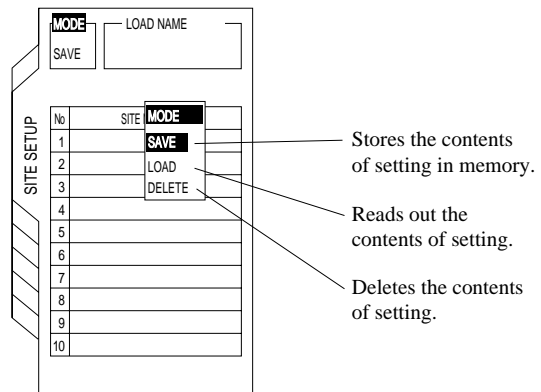

- ③ To select “SAVE” or “LOAD”, select a name (No.) of a site by using the cursor and press the ENT key. So, this function enables you to save and load the data.

Note) When using the “SAVE” function, it is necessary to enter “SITE NAME” in advance.

The name set in the “SITE NAME” given on page 6-3, “PIPE PARAMETER” is saved.

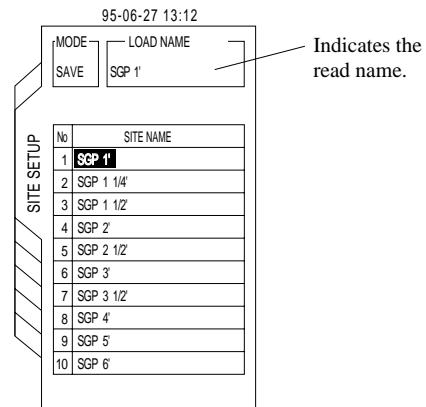

- ④ When selecting “DELETE”, select the site name (No.) by using the cursor, and press the ENT key, so the data will be deleted. Be careful since registered pipe parameter data are deleted.

9.1.2 ZERO ADJUST: when performing zero adjustment

On this screen, zero point is adjustable.

Operation

- ① Select "ZERO ADJUST" by the ▲ or ▼ key and press the ENT key. The zero adjustment screen will appear.
- ② Select ZERO ADJUST, and press the ENT key. Zero adjustment to be specified is carried out.

• [Manual zero]

Perform zero adjustment in situation where the flow is stopped.

The measurement indication should be at zero when the ENT key is pressed.

This zero calibration operation should be performed after stopping flow.

• [Clear]

Calibration is performed without stopping flow. Calibration value by MANUAL ZERO is cleared.

⚠ CAUTION

When PIPE PARAMETER or measurement method (page 9-17) is changed, perform zero adjustment.

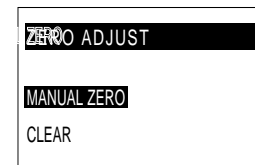
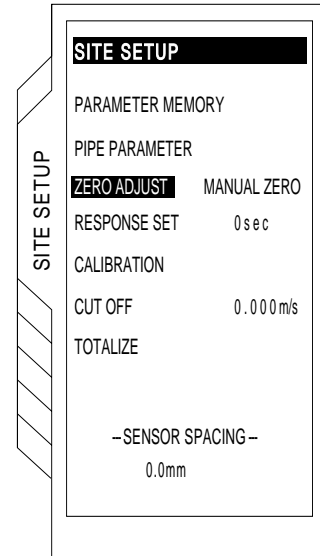

9.1.3 RESPONSE SET : when changing output response

The response time of output is to be set here. (range: 0 to 99 sec)

This function is used when stabilizing the output or responding to the high velocity.

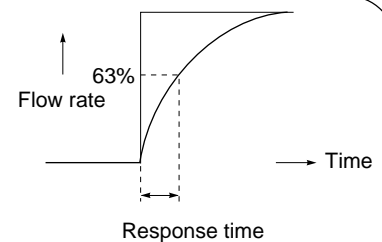

[Operation]

- ① Press the ▲ or ▼ key on the SITE SETUP page and select "RESPONSE SET". Press the ENT key, and the cursor moves to the set item, enabling you to set the response time.
- ② Move the digit by pressing the ◀ or ▶ key and enter numeric values by using the ▲ or ▼ key. After entry, press the ENT key for setting.

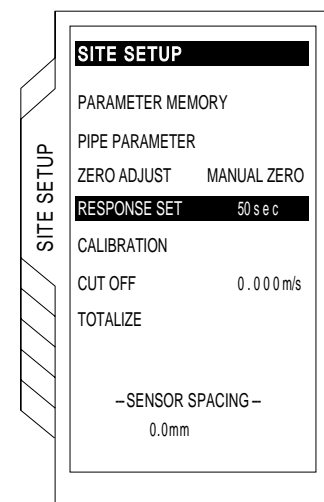

9.1.4 OUTPUT CORRECTION: when calibrating measured value (output calibration function)

This function enables you to set correction values.

[Settable range of zero point: -1.000 m/s to 1.000 m/s]
 [Settable range of span: 0 to 200%]

Calculation of output value

$$\text{Measured value} \times \frac{\text{Set span value}}{100} + \text{Set zero-point value} = \text{Output value}$$

[Operation]

- ① To open the “CALIBRATION” screen, press the or key on the SITE SETUP page and select “CALIBRATION”. Then, press the key.

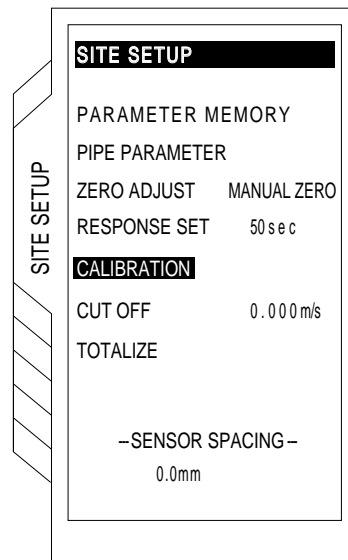

- ② Set zero-point and span-point.

Move the cursor to “ZERO” or “SPAN” and press the key. Zero and span points are settable. Press the or key to move the digit, and use the or key to enter a numeric value. After entry, press the key.

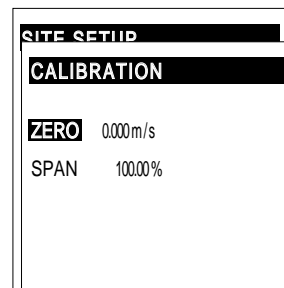

⚠ CAUTION

As output is corrected, measured value changes.
 It is recommended to set as follows unless correction is required.
 Zero point: 0.000 m/s
 Span point: 100.00%

9.1.5 CUT OFF: output cut off at low flow rate (low flow cutoff function)

When flow rate is extremely low, its output can be cut off. (range: 0 to 1.000 m/s)
If fluid in the pipe is moving due to convection, etc., even though the valve is closed, this flowmeter outputs a measured value. Therefore, values below an appropriate level should be cut off.

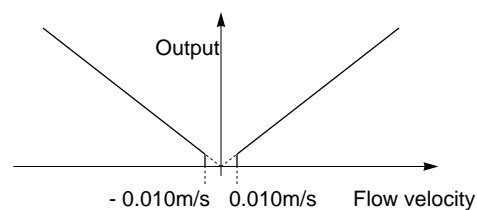

[Operation]

- ① Press the \blacktriangle or \blacktriangledown key on the SITE SETUP page and select CUT OFF. Then, press the ENT key, and the cursor moves to the set item. Output cut off point is settable.
- ② Move the digit by pressing the \blacktriangleleft or \blacktriangleright key and enter a numeric value by pressing the \blacktriangle or \blacktriangledown key.
After entry, press the ENT key.

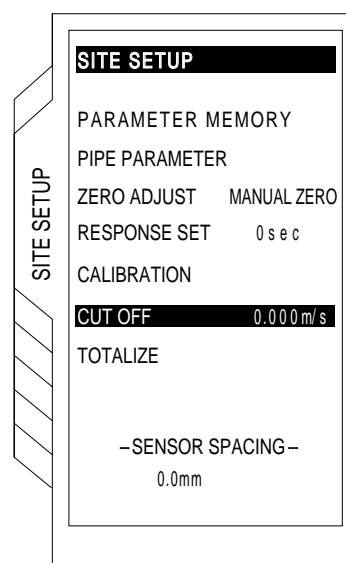

9.1.6 TOTALIZE: when performing the integration process of measured data (totalize)

Setting is required here when using integration output.

[Operation]

Select "TOTALIZE" by the ▲ or ▼ key and press the **ENT** key. The "TOTALIZE" screen will appear.

① To start integration

To open the Integration Output Selection screen, move the cursor to "MODE" and press the **ENT** key.

To set the integration output, select the integration output and press the **ENT** key.

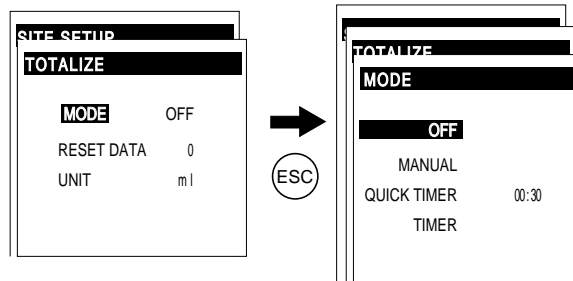
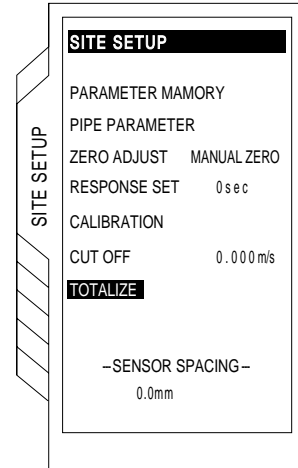

Mode	Description
OFF	Integration stop
Manual	Instant integration start
Quick timer	Integration starts after the time of setting, integration is performed within the time selected from the menu, and it stops automatically after the time passed. <div style="float: right; margin-top: 10px;"> </div>
Timer	Set the time of integration to start and stop. Point the cursor to "TIMER START", and then press the ENT key. Integration starts and stops automatically. ⚠ Point the cursor to "TIMER START", and integration will not be started until the ENT key is pressed. Even if the timer settig is performed after scheduled start time already passed, integration will not be carried out. <div style="float: right; margin-top: 10px;"> </div>

② To set reset data

To reset the integration reset data, move the cursor to “RESET DATA” and press the **(ENT)** key. Select numerical values by pressing the **(▲)**, **(▼)**, **(◀)**, **(▶)** key and press the **(ENT)** key.

[Settable range: 0000000 to 9999999]

Resetting actual integral values should be performed on the “MEASURE” screen. (See page 8-1).

③ To change integration unit

To set integration units, move the cursor to “UNIT” and press the **(ENT)** key. The Unit screen appears, prompting you to select units of integration. Select units by pressing the **(▲)** or **(▼)** key and press the **(ENT)** key.

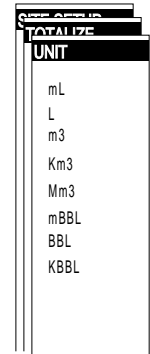
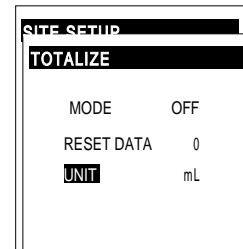
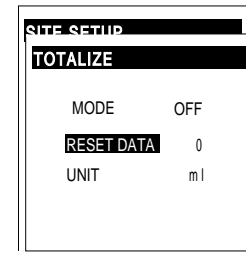

9.2 Setting of logging function (data logger page)

This function allows you to save measured values to the memory of the main unit, call the measured data saved to the memory after measurement is completed, display, and produce output of them on a printer. The data logger can contain up to 40,000 measured data.

How to view data logger

95-06-27 15:01

MODE	REMAIN	
SETUP	120 BLOCK	

No	LOG NAME	DATA
1		✓
2	Flow Site.	
3	**EMPTY**	
4	**EMPTY**	
5	**EMPTY**	
6	**EMPTY**	
7	**EMPTY**	
8	**EMPTY**	
9	**EMPTY**	
10	**EMPTY**	

Sets operation.

Indicates the storage status. ****EMPTY**** indicates that data is not stored.

Up to 20 boxes can be viewed by using the cursor.

Indicates the number of remaining memory blocks. One block consists of 156 data. No. of all blocks: 256

Calculation of remaining amount of memory
 In case of 120 blocks
 120 blocks × 156 data = 18720 data
 If the setting contents exceed the remaining amount of memory, the data logger is not available.
 The message appears as shown below.

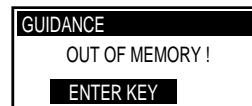

Set the setting contents within the range of the remaining amount of memory.

When the data is already saved, the check mark (✓) is placed here.

(1) SETUP: when setting logging of measured data

“SETUP” only sets logging conditions.
 To start logging, follow the steps ⑩ and ⑫ given on page 9-10.

[Operation]

① To open the MODE selection screen, move the cursor to “MODE” and press the **(ENT)** key. Press the **(▲)** or **(▼)** key to select “SETUP” and press the **(ENT)** key.

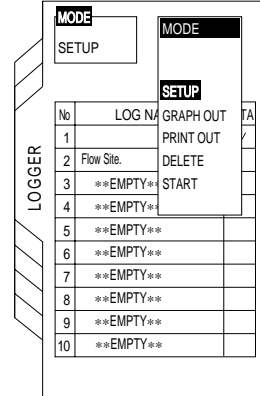

② Press the **(▲)** or **(▼)** key to select No. and press the **(ENT)** key.
 No. with a check mark cannot be selected.

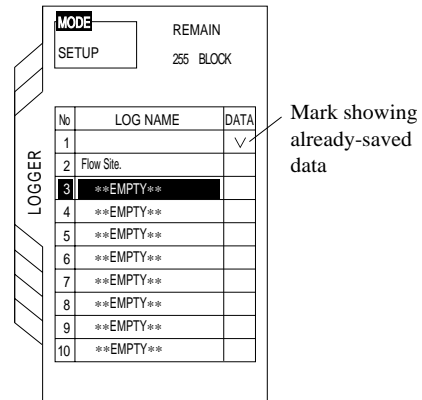

③ Select “LOG NAME” and press the **(ENT)** key, and the Entry screen is displayed.

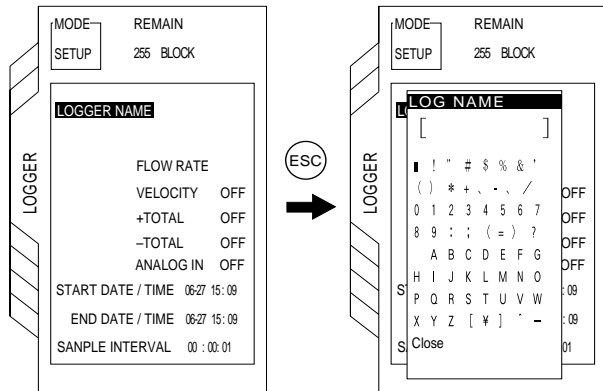

④ Registers the place or pipe name for logging.

- Select a character and press the **(ENT)** key. Characters are displayed one by one at the top of screen.
- Select “CLOSE” and press the **(ENT)** key. The input is now completed.
- If you have entered wrong characters, press the **(ESC)** key. Characters can be erased one by one.

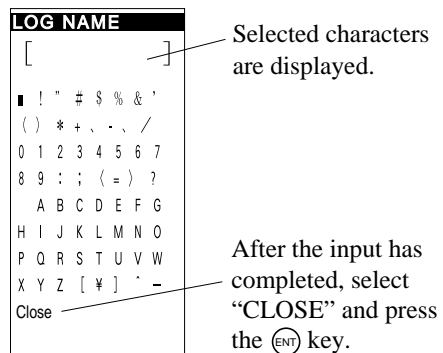

- ⑤ Select the kind of data to be logged.

One or more data can be selected.

Select the kind of data by the ▲ or ▼ key, turn it ON and press the ENT key for starting logging.

- Move the cursor to any of “FLOW RATE”, “VELOCITY”, “+TOTAL”, “-TOTAL” and “ANALOG IN”. Press the ENT key, and the “ON/OFF SELECTION” screen is displayed.
- Select “FLOW RATE” and press the ENT key, and then the “UNIT” selection screen is displayed. Move the cursor to any of the flow rates units and press the ENT key. Set either ON or OFF.
- To select “VELOCITY”, “+TOTAL”, “-TOTAL” and “ANALOG IN”, move the cursor to any of them and press the ENT key. Then select ON or OFF.

[Example] To save flow rate [m³/h]

Select “FLOW RATE” and press the ENT key. Move the cursor to [m³/h], select “ON” and press the ENT key. To close the screen, press the ENT key.

Registered name is displayed.

MODE: REMAIN
SETUP: 255 BLOCK

LOGGER

LOGGER NAME
TEST 123
FLOW RATE
VELOCITY OFF
+TOTAL OFF
-TOTAL OFF
ANALOG IN OFF
START DATE / TIME 10:30 05:17
END DATE / TIME 10:30 05:17
SAMPLE INTERVAL 00 : 00: 01

unit	
L / s	OFF
L / min	OFF
L / h	OFF
ML / d	OFF
m3 / s	OFF
m3 / min	OFF
m3 / h	OFF
Mm3 / d	OFF
BBL / s	OFF
BBL / min	OFF
BBL / h	OFF
MBBL / d	OFF

VELOCITY
OFF
ON

+TOTAL
OFF
ON

-TOTAL
OFF
ON

ANALOG IN
OFF
ON

UNIT

m³/h
OFF
ON

Note) For FLOW RATE, one or more units are selectable. Select the units of flow rate on the UNIT screen.

MODE: REMAIN
SETUP: 255 BLOCK

LOGGER

LOGGER NAME
TEST 123
FLOW RATE
VELOCITY OFF
+TOTAL OFF
-TOTAL OFF
ANALOG IN OFF
START DATE / TIME 10:30 05:17
END DATE / TIME 10:30 05:17
SAMPLE INTERVAL 00 : 00: 01

- ⑥ Select “START DATE/TIME” and press the ENT key, so the setting can be accomplished.
- ⑦ Select “END DATE/TIME” and press the ENT key, so the setting can be accomplished.
- ⑧ Select “SAMPLE INTERVAL” and press the ENT key, so the setting can be accomplished.

Pressing the ◀ or ▶ key moves the digit, and enter numeric values by pressing the ▲ or ▼ key.

After entry, press the ESC key.

First, the present time is displayed
Example)

When setting the start time at 15: 09 on June 27:
|START DATE/TIME: 06-27 15:09|

Example)

When setting the sample interval at 01: 20 : 00:
|SAMPLE INTERVAL: 01: 20: 00|

CAUTION

Set the timer at a few minutes earlier than present time, or the setting will be performed at one year later.

- ⑨ Press the **(ESC)** key 2 times to return to the initial LOGGER screen (at right).

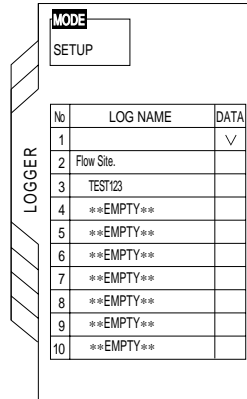

- ⑩ Open the “MODE” selection screen by pressing the **(ENT)** key. Press the **(▲)** or **(▼)** key to select “START”, and press the **(ENT)** key.

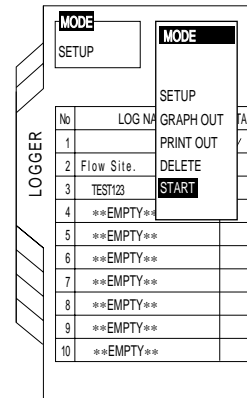

- ⑪ Select the name of already set logger and press the **(ENT)** key.

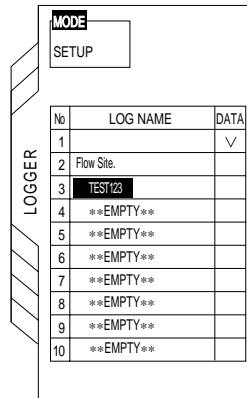

- ⑫ The screen is displayed as shown at right. Sampling of the logger will be started. Pressing the **(ENT)** key closes the screen.

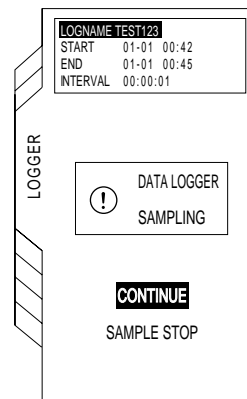

(2) GRAPH: when checking logged data on screen

[Operation]

- ① Press the ▲ or ▼ key on the LOGGER page to select “GRAPH OUT” from “MODE”. Press the ENT key to open the “LOG NAME” selection screen.
- ② Select the name (No.) of logger by pressing the ▲ or ▼ key. and press the ENT key. The graph display screen opens.

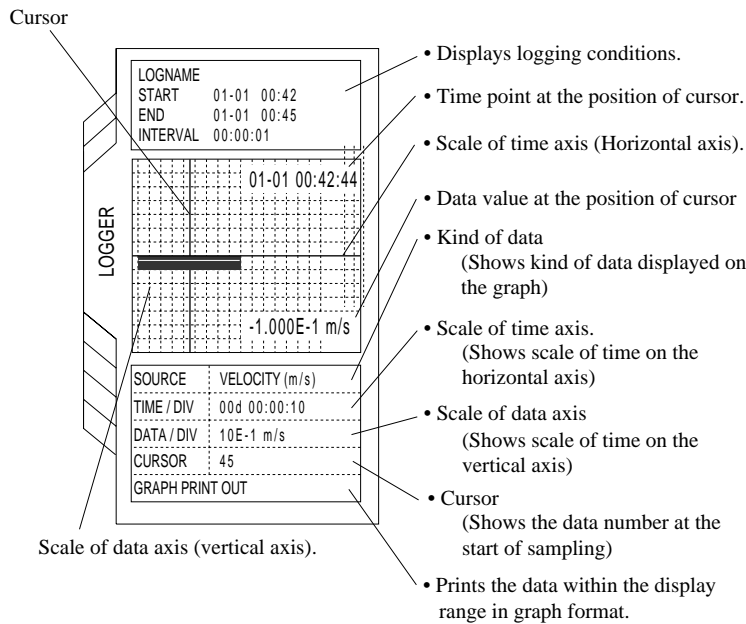
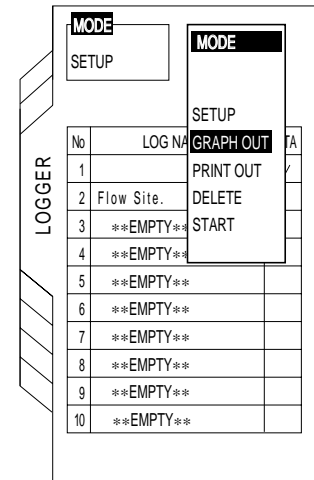

- ③ To change kind of data to be displayed, move the cursor to “SOURCE” and select the unit by pressing the ◀ or ▶ key.

Note) Unit of logged data can only be displayed.

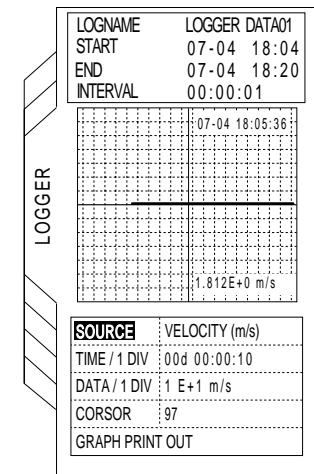

- ④ To change scale of time axis (horizontal axis) Move the cursor to “TIME/1DIV” to enlarge or contract the time axis by the ◀ or ▶ key.

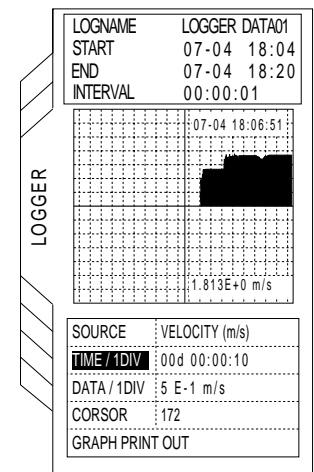

- ⑤ To change scale on data axis (vertical axis)

Move the cursor to “DATA/1 DIV” to enlarge or contract the data axis by the ◀ or ▶ key.

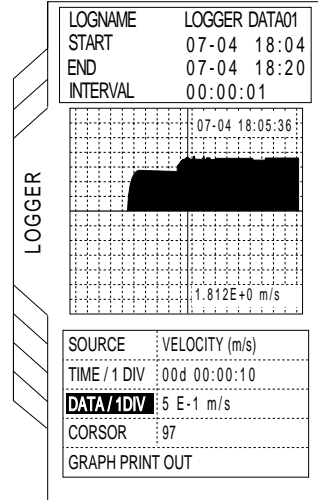

- ⑥ To display time and data values of cursor

Move the cursor to “CURSOR”. Move the cursor by pressing the ◀ or ▶ key to display the data value of the time.

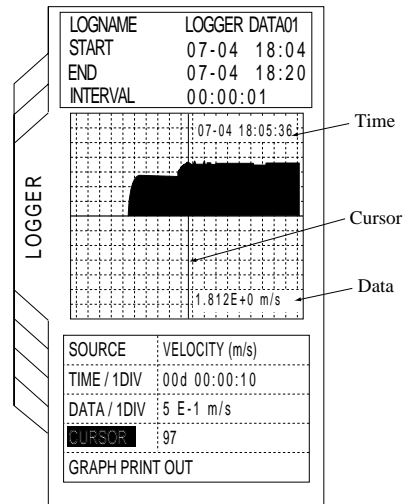

- ⑦ To print graph

Move the cursor to “GRAPH PRINT OUT” and print a graph by pressing the (ENT) key.

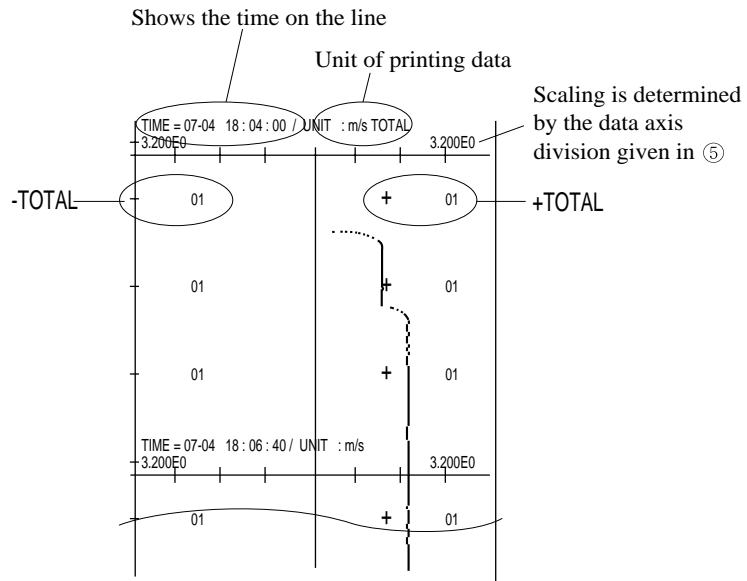
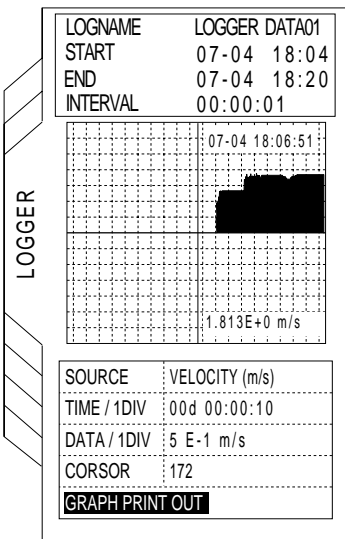

Reference

Pressing the (PRINT) key allows producing hard copy output of a screen.

(3) PRINT: when printing logged data in text

[Operation]

① To open the MODE selection screen, move the cursor to "MODE" and press the **(ENT)** key. Press the **(▲)** or **(▼)** key to select "PRINTOUT" and press the **(ENT)** key.

② Press the **(▲)** or **(▼)** key to select "No." and press the **(ENT)** key.

③ Set the printing conditions.

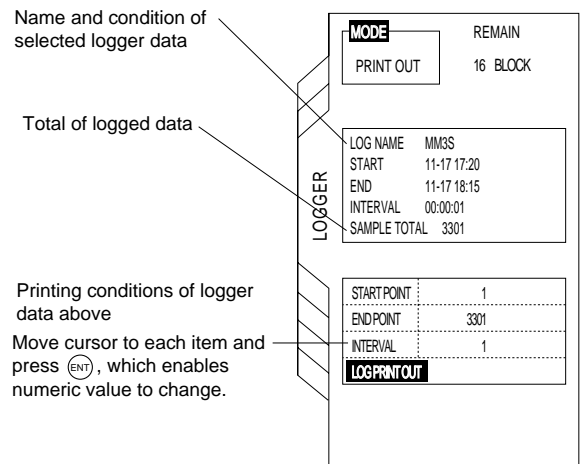
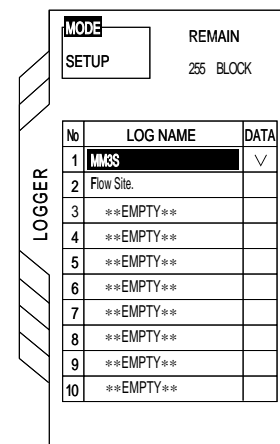
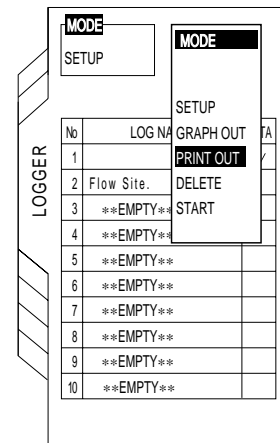

Name and condition of selected logger data

Total of logged data

Printing conditions of logger data above

Move cursor to each item and press **(ENT)**, which enables numeric value to change.

[Example]

3301 data are saved to the "MM3S" logger data every second. The logger data from the 120th (at 17: 22) to the 420th (at 17: 27) are printed out every 10 seconds.

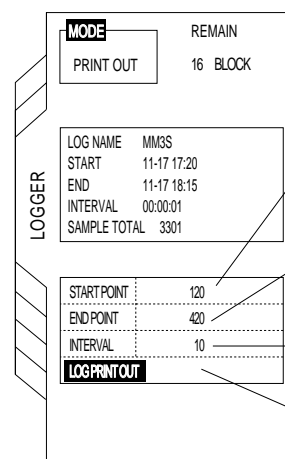

1. Select "START POINT" and press **(ENT)**. Change to 120 by **(▲)** or **(▼)** keys.
2. Select "END POINT" and press **(ENT)**. Change to 420 by **(▲)** or **(▼)** keys.
3. Select "INTERVAL" and press **(ENT)**. Change to 10 by **(▲)** or **(▼)** keys.
4. Select "LOG PRINT OUT" and press **(ENT)**, and printing is started.

(4) DELETE: when deleting logged data

[Operation]

- ① Press the ▲ or ▼ key on the LOGGER page and select “DELETE” from “MODE”.

Press the **(ENT)** key, and the LOG NAME SELECTION screen is displayed.

- ② Select LOG NAME (No.) by the ▲ or ▼ key and press the **(ENT)** key.

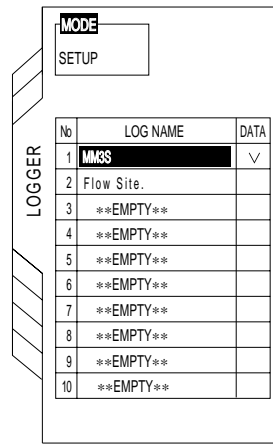
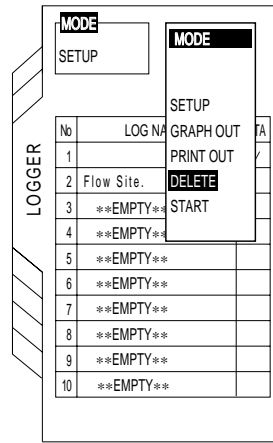

(5) START: when starting logging [logging starts by conditions set in (1), “SETUP”]

[Operation]

- ① Press the ▲ or ▼ key on the LOGGER page and select “START” from “MODE”.

Press the **(ENT)** key, and the LOG NAME SELECTION screen is displayed.

- ② Select LOG NAME (No.) by the ◀ or ▶ key and press the **(ENT)** key, and the screen in the logging process is displayed. The logging process can be continued even if switching to other screen.

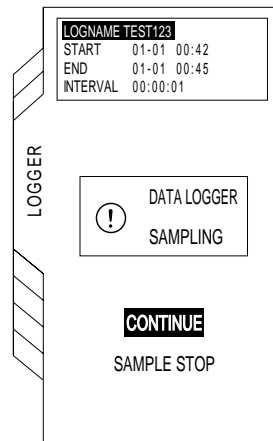
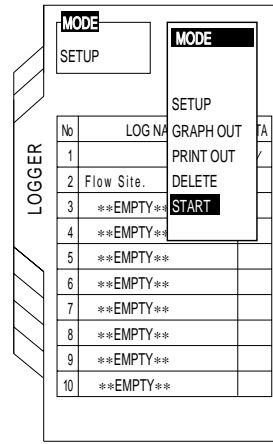

! CAUTION

To cancel the logging process halfway, move the cursor to SAMPLE STOP and press the **(ESC)** key.

9.3 Setting of system (page title: SYSTEM SETUP)

This function allows you to accomplish the system setup including setup of clock, setup of communication functional conditions (required for serial transmission), and measurement unit settings, etc.

9.3.1 CLOCK SET: when setting the clock (set the present time)

- Press the \blacktriangle or \blacktriangledown key on the SYSTEM SETUP page and select "CLOCK SET". Press the ENT key, and you are ready to set the clock.
- Move the digit by the \blacktriangleleft or \blacktriangleright key and enter numeric values by the \blacktriangle or \blacktriangledown key. After entry, press the ENT key. The setup time becomes valid at this point.

Setup contents

99-10-10 13: 09: 00

(year, month, day, hour, minute, second)

SYSTEM SETUP	
CLOCK SET	99-10-30 07:08:00
COMMUNICATION	
BAUD RATE	9600
PARITY	NONE
STOP BIT	1 BIT
SYSTEM OF UNITS	METRIC
MEASUREMENT METHOD	1
MEMORY INITIALIZE	

CAUTION

When the integrated data logger uses the timer function of a printer, change of the clock setup will stop the action of the timer function. Then, set the timer setup again.

9.3.2 COMMUNICATION: when setting serial communication (data communication to personal computer)

- Move the cursor to any of "BAUD RATE", "PARITY", and "STOP BIT" by pressing the \blacktriangle or \blacktriangledown key on the SYSTEM SETUP page.

SYSTEM SETUP	
CLOCK SET	95-06-25 15:17:00
COMMUNICATION	
BAUD RATE	9600
PARITY	NONE
STOP BIT	1 BIT
SYSTEM OF UNITS	METRIC
MEASUREMENT METHOD	1
MEMORY INITIALIZE	

- To open the SYSTEM SETUP screen, press the ENT key.

Select the set value by the \blacktriangle or \blacktriangledown key and press the ENT key. (For details, refer to chapter 12. SPECIFICATIONS FOR SERIAL TRANSMISSION.

SYSTEM SETUP	
CLOCK SET	95-06-25 15:17:00
COMMUNICATION	
BAUD RATE	9600
PARITY	NONE
STOP BIT	1 BIT
SYSTEM OF UNITS	METRIC
MEASUREMENT METHOD	1
MEMORY INITIALIZE	

BAUD RATE
300
600
1200
2400
4800
9600

PARITY
NONE
EVEN
ODD

STOP BIT
1 BIT
2 BIT

9.3.3 SYSTEM OF UNITS: when setting the measurement and setting unit system [selection of meter system and inch system]

[Operation]

- ① Select "SYSTEM OF UNITS" by the ▲ or ▼ key on the SYSTEM SETUP page. Press the **ENT** key, and the SYSTEM OF UNITS screen is displayed, prompting you to select units of either meter system or inch system.

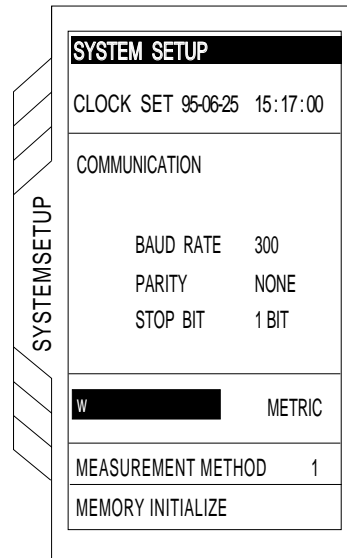

- ② Select "METRIC" or "INCH" by the ▲ or ▼ key and press the **ENT** key.

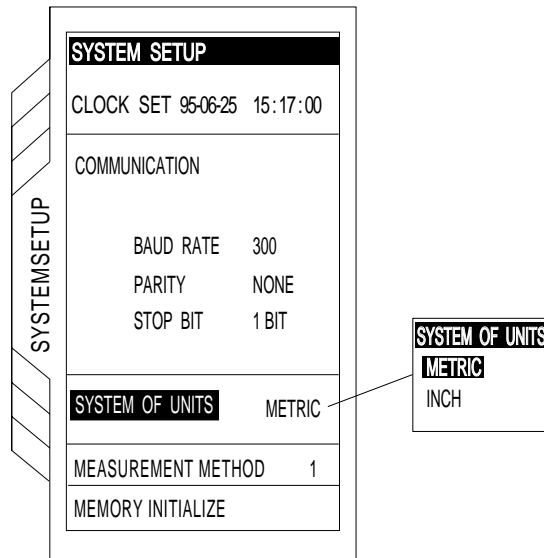

CAUTION

The setting contents in the memory range are available in metric and inch systems. If you switch the unit system, the memory range is switched accordingly, where different setting contents are displayed. Select any of them according to your setting.

9.3.4 MEASUREMENT METHOD: when changing measurement method

Measurement method 1 is the standard measurement method.

The measurement method 2 resists an external disturbance.

If the method 1 is not available, change it to the method 2.

The measurement system is automatically selected according to the kind of sensor or setting of outer diameter. If the measurement method 2 is automatically selected from the beginning, there is no need to switch the method. 2. For the method 1 that has been automatically selected, change to the method 2 is possible.

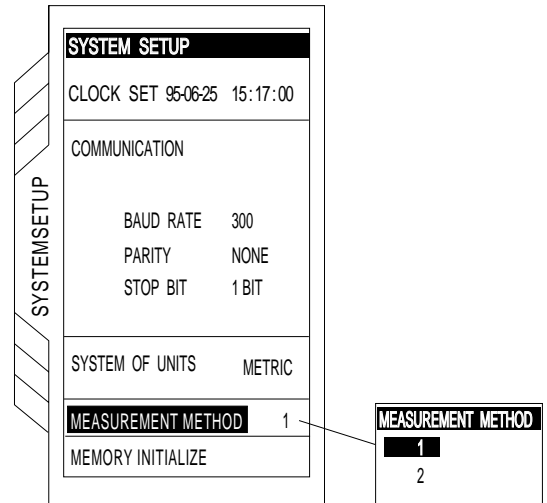

⚠ CAUTION

The measurement method is initialized according to the kind of sensor or outer diameter setting at the power ON or just when the PIPE PARAMETER screen is displayed on the SITE SETUP page. After changing from method 1 to method 2, set the measurement method again when the power is turned OFF or the PIPE PARAMETER screen is displayed.

⚠ CAUTION

When the measurement method has been changed from method 1 to method 2, measurement values are subjected to change.

9.3.5 MEMORY INITIALIZE: all setting parameters and logger data are initialized.

Turn off the power after selecting “YES” and then turn it on again.

Initializing will be started.

If selecting “NO” without turning off the power, initializing will not be carried out.

⚠ CAUTION

After setting, turn off the power once, and turn it ON again for initializing the memory data

⚠ CAUTION

Analog input/output calibration values and language selected are held.

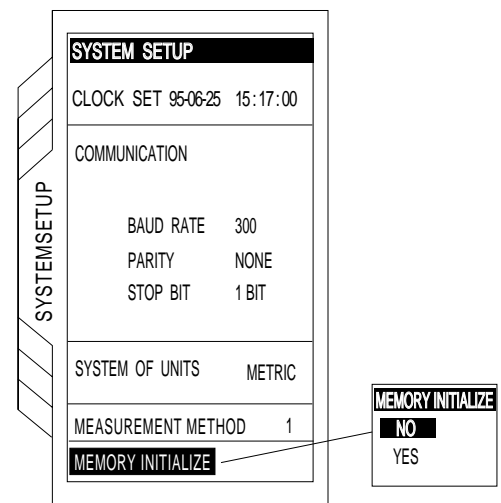

Note) Initialized items

All memory data with the exception of

- ① Language selected
- ② Analog input /output calibration value

9.4 Setting of analog input/output (analog page)

This function allows you to set the measurement range, range, output mode, error handling for analog input/output. It also allows you to perform output calibration.

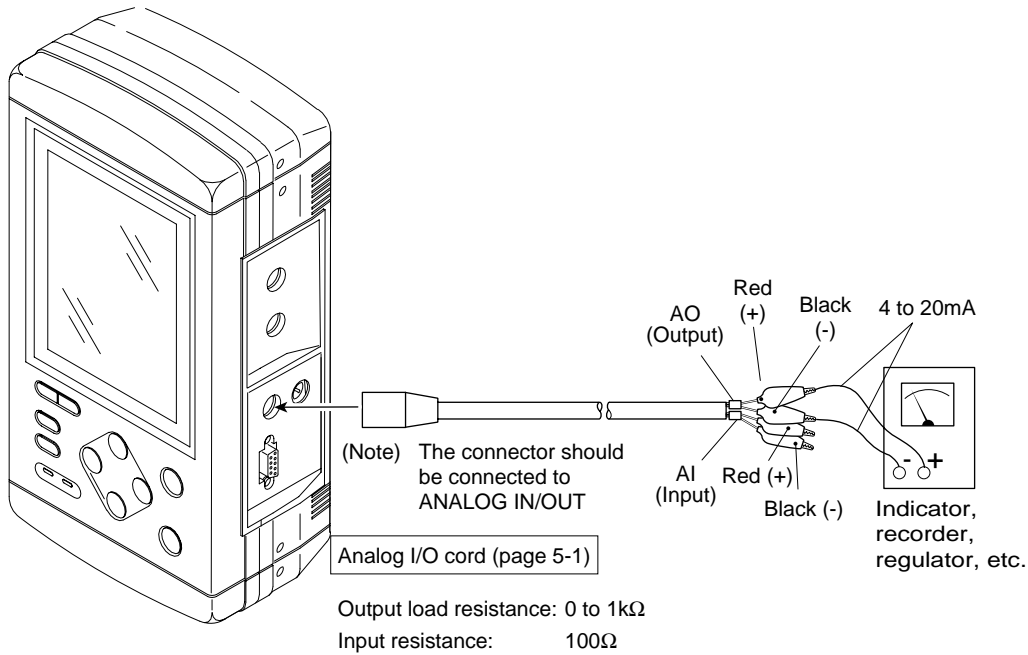

9.4.1 Setting of analog input

(1) ADJUST: when performing zero adjustment and span adjustment for input signals

[Operation]

- ① Press the ▲ or ▼ key on the “ANALOG IN/OUT” page and select “ADJUST” from “INPUT”.

Press the ENT key, and you are ready to adjust input signals.

- ② Input 4 mA from an external and move the cursor to “4 mA” by the ▲ or ▼ key. Then press the ENT key to perform zero adjustment.
- ③ Input 20 mA from the external and move the cursor to “20 mA” by the ▲ or ▼ key. Then press the ENT to perform span adjustment.

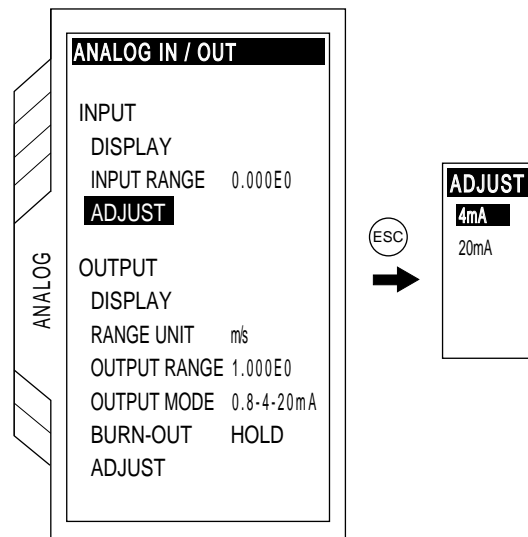

(2) INPUT RANGE: when setting the range of input current

- ① Press the ▲ or ▼ key on the “ANALOG IN/OUT” page and select “INPUT RANGE” from “INPUT”.

Press the ENT key, and you are ready to adjust input range.

- ② Move the digit by the ◀ or ▶ key and enter numeric values by pressing the ▲ or ▼ key. After entry, press the ENT key to set the range.

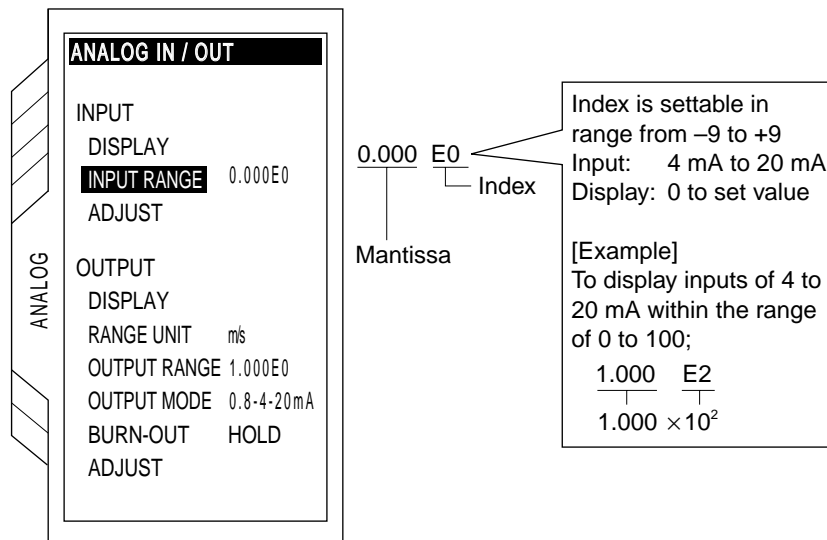

(3) DISPLAY: when displaying values by entering analog signals (4 to 20 mA) of other devices

- ① Press the ▲ or ▼ key on the “ANALOG IN/OUT” page and select “DISPLAY” from “INPUT”.

Press the ENT key to display present instantaneous flow and input value. Selection of “INPUT” indicates a displayed value equal the input current converted into input (%) × OUTPUT RANGE.

$$\text{Display} = \frac{\text{INPUT (\%)}}{100} \times \text{OUTPUT RANGE}$$

$$\frac{\text{Input current} - 4\text{mA}}{16\text{mA}} \times 100$$

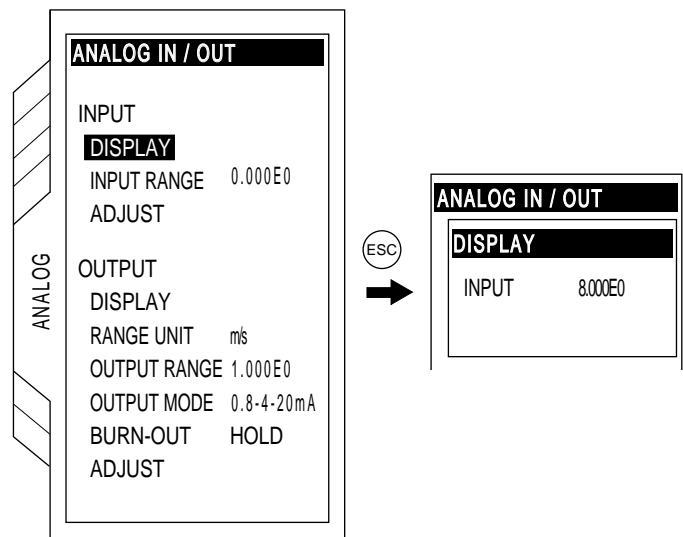

9.4.2 Setting of analog output

(1) DISPLAY: when displaying present measured instantaneous flow

[Operation]

- Press the \blacktriangle or \blacktriangledown key on the “ANALOG IN/OUT” page and select “DISPLAY” from “OUTPUT”.

Press the ENT key to display presently-measured instantaneous flow.

CAUTION

The “OUTPUT RANGE” initial value is 0.000E0. Unless “OUTPUT RANGE” is set, “DISPLAY” is 0.00%.

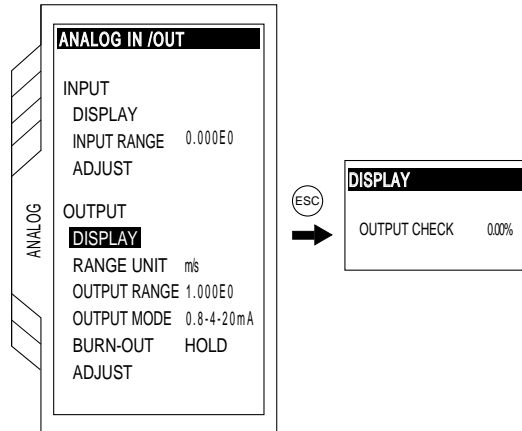

$$\text{Output} = \text{instantaneous flow} \times 100/\text{range}$$

(2) RANGE UNIT: when setting measurement unit

- Press the \blacktriangle or \blacktriangledown key on the “ANALOG IN/OUT” page and select “RANGE UNIT” from “OUTPUT”.

Press the ENT key, and the “UNIT” screen is displayed, enabling you to select the measurement unit.

- Select the measurement unit by the \blacktriangle or \blacktriangledown key and press the ENT key.

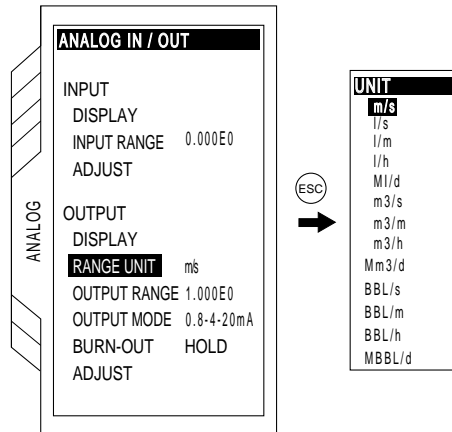

(3) OUTPUT RANGE: when setting the range for output current

- Press the \blacktriangle or \blacktriangledown key on the “ANALOG IN/OUT” page and select “OUTPUT RANGE” from “OUTPUT”.

Press the ENT key, and you are ready to adjust output range.

- Move the digit by the \blacktriangleleft or \blacktriangleright key and enter numeric values by pressing the \blacktriangle or \blacktriangledown key. After entry, press the ENT key to set the range.

Example) In case of the range of 0 to 80 L/s at 4 to 20 mA

8.000 E1 (8.000 × 10)

Mantissa Index Index is settable in range from -9 to +9

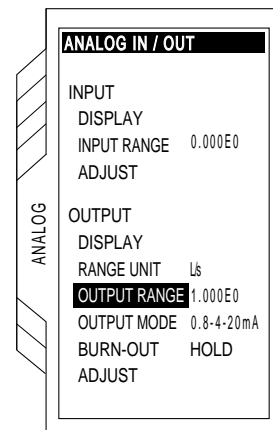

CAUTION

Set RANGE so that flow rate to be measured exceeds 1.2 times its maximum value. If measured value exceeds the set value, the status display on the MEASURE screen turns “ANALOG OUTPUT ERROR”. Unless analog output is used, set the range at 0, and “ANALOG OUTPUT ERROR” is not displayed.

(4) OUTPUT MODE: when setting the output mode

- Press the \blacktriangle or \blacktriangledown key on the “ANALOG IN/OUT” page and select “OUTPUT MODE” from “OUTPUT”.

Press the ENT key, and the screen is displayed, enabling you to select the output mode.

- Select the output mode by the \blacktriangle or \blacktriangledown key and press the ENT key.

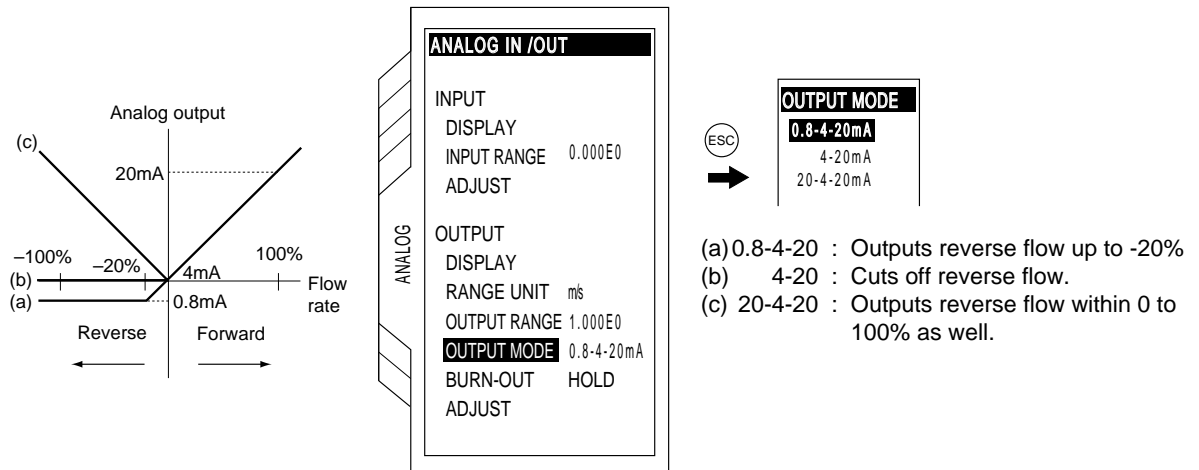

(5) BURN-OUT: when setting the burn-out process

[Operation]

When an error occurs, set a current output to forcibly set value. When solving the trouble, the current output is automatically restored.

“BURN-OUT” means all errors except for “ANALOG OUTPUT ERROR”.

- Press the \blacktriangle or \blacktriangledown key on the “ANALOG IN/OUT” page and select “BURN-OUT” from “OUTPUT”.

Press the ENT key, and the BURN-OUT screen

- Select any of BURN-OUT items by the \blacktriangle or \blacktriangledown key and press the ENT key.

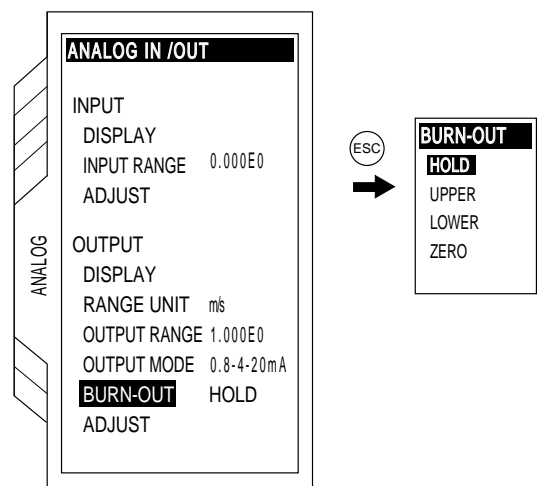

- **HOLD:** Holds output indications before the occurrence of errors.
- **UPPER:** Outputs (120%, 23.2 mA) at upper limit
 $16 \text{ mA} \times 1.2 + 4 = 23.2 \text{ mA}$
- **LOWER:** Outputs (-20%, 0.8 mA) at lower limit
 $16 \text{ mA} \times (-0.2) + 4 = 0.8 \text{ mA}$
- **ZERO:** Outputs (0%, 4 mA) at zero point

(6) ADJUST: when adjusting output circuit (prepare an ammeter)

- ① Press the ▲ or ▼ key on the “ANALOG IN/OUT” page and select “ADJUST” from “OUTPUT”. Press the ENT key, and the ADJUST screen is displayed, enabling you to calibrate the output circuit.
- ② Select either 4 mA or 20 mA by the ◀ or ▶ key. Adjust the output circuit so that outputs are adjusted to either 4 mA (0% output calibration) or 20 mA (100% output calibration) by pressing the ▲ or ▼ key.
- ③ Press the ENT key to set the outputs.

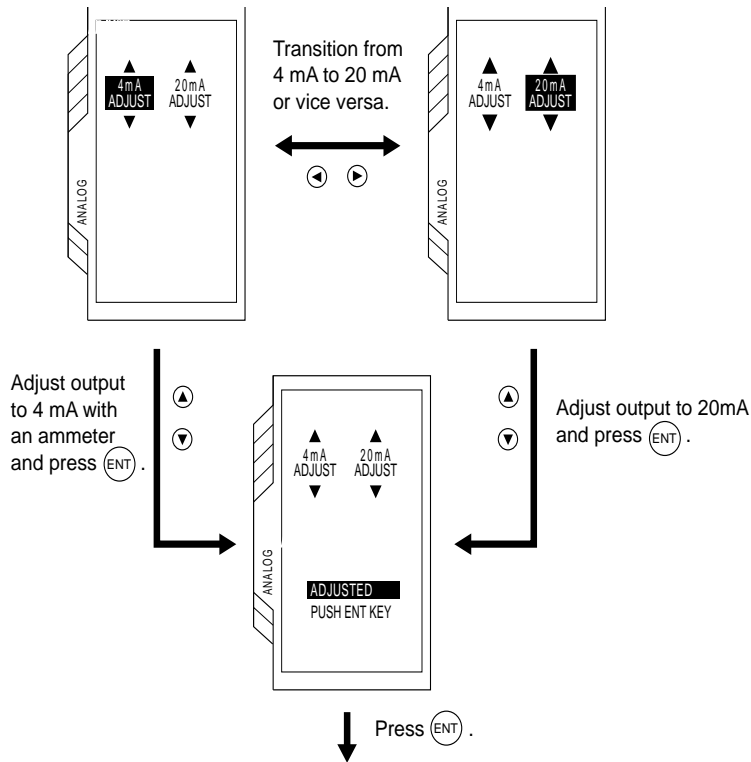

9.5 Use of printer function (PRINTER page)

It allows you to print measured value as well as hard copy on an optional printer. On this page, setting for printing measured values can be performed.

9.5.1 Selection of mode

- ① Move the cursor to "MODE" on the PRINTER page and press the **ENT** key. The "MODE" screen is displayed. Select any of the modes of "TEXT", "GRAPH", and "LIST" by the **▲** or **▼** key and press the **ENT** key. For the meaning of each mode, refer to an example of the following printing.

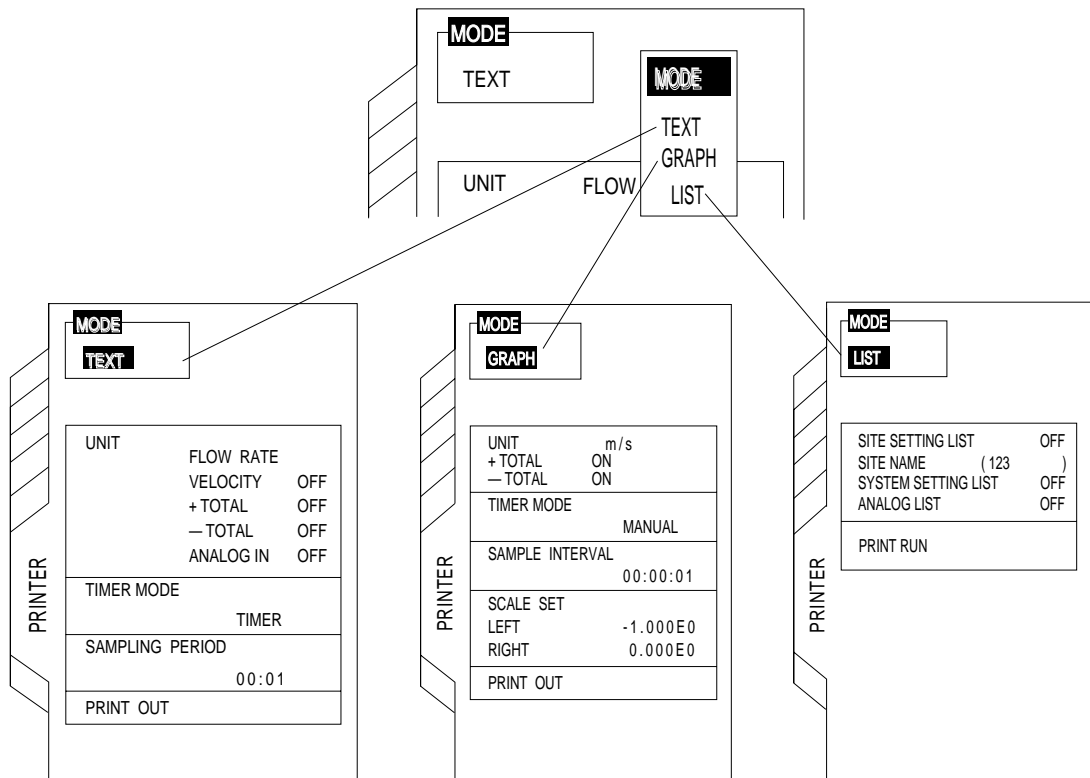

TEXT mode

Prints data for selected unit in industrial value.

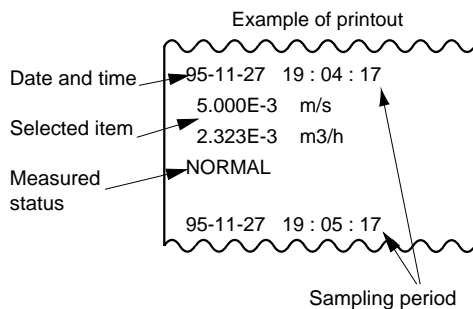

GRAPH mode

Prints data for selected unit in graph.

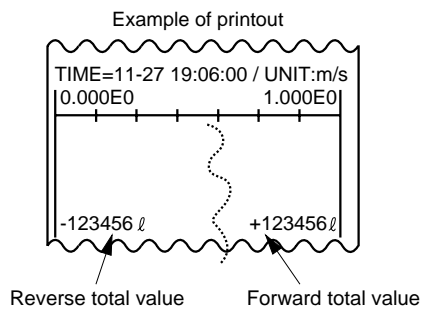

LIST mode

Selected list

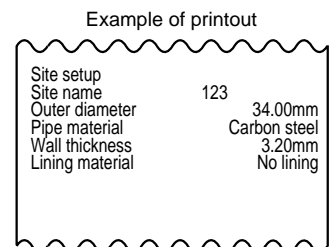

9.5.2 Selection of items to print

(1) TEXT mode

Up to 16 items available for printing are enumerated below:

- Flow rate (12 items)
- Flow velocity
- + Total
- - Total
- Analog input

Note) Items in 9.1. 6 TOTALIZE should be set.

Only desired items out of 16 items are allowed to print. One or more items are selectable simultaneously.

- ① Press the \blacktriangle or \blacktriangledown key on the PRINTER page and select "FLOW RATE". Press the $\text{\textcircled{ENT}}$ key, and the FLOWRATE screen is displayed, enabling you to select any of displayed units.

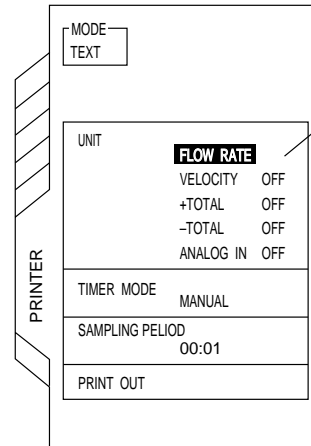

Since one or more items can be selected, "ON/OFF" is not displayed.

- ② Press the \blacktriangle or \blacktriangledown key to select the item (one or more items are selectable) to print and press the $\text{\textcircled{ENT}}$ key.
- ③ To execute printing, select "ON" and press the $\text{\textcircled{ENT}}$ key.

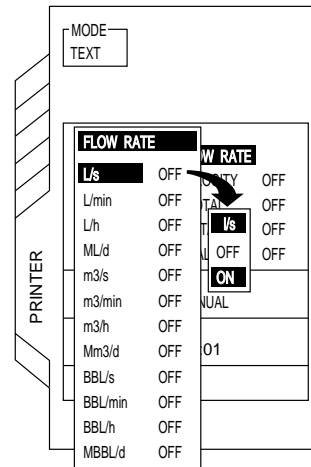

- ④ When selecting the "FLOW RATE", "TOTAL" and "ANALOG IN" printing units, move the cursor to any of them and press the $\text{\textcircled{ENT}}$ key. To execute printing, select "ON" and press the $\text{\textcircled{ENT}}$ key.

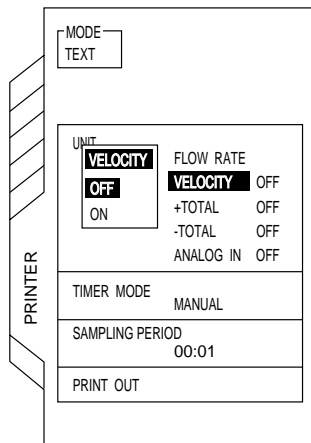

(2) GRAPH mode

- ① Press the ▲ or ▼ key on the PRINTER page, select “UNIT” and press the ENT key. The UNIT screen is displayed, enabling you to select the unit.

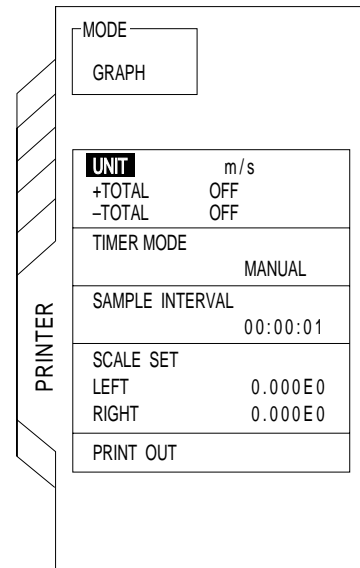

- ② Press the ▲ or ▼ key to select one of items to print and press the ENT key.

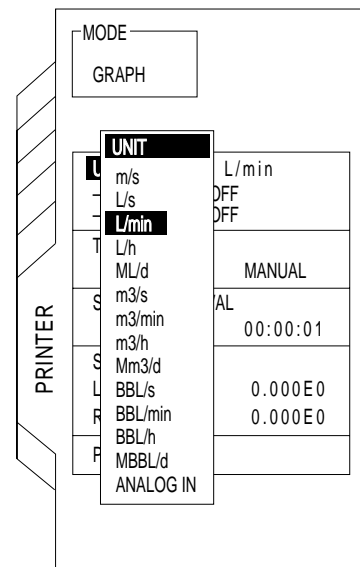

- ③ Turning “+TOTAL” and “-TOTAL” ON prints integrated value in a graph. (See an example of printing on page 9-23).

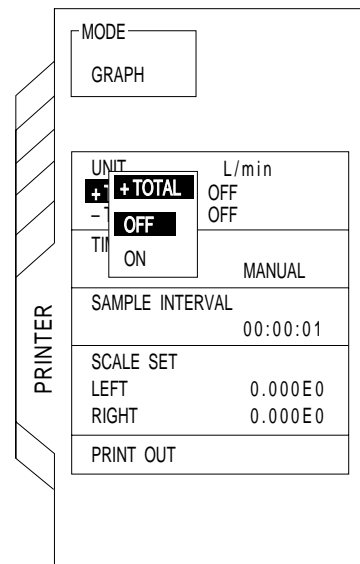

(3) LIST mode

- Press the ▲ or ▼ key on the PRINTER page, select any of “SITE SETTING LIST”, “SYSTEM SETTING LIST”, and “ANALOG LIST” for printing and press the **ENT** key.

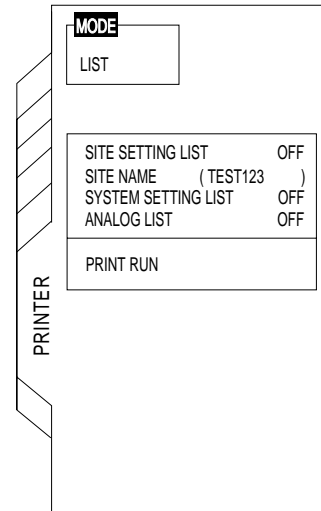

- Select “ON” and press the **ENT** key.

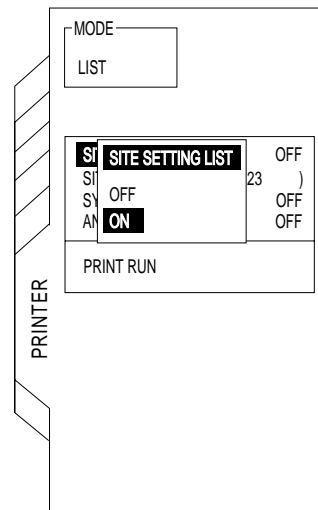

Example of site setting list

Site setup	
Site name	TEST123
Outer diameter	34.00mm
Pipe material	Carbon steel
Wall thickness	3.20mm
Lining material	No lining
Lining thickness	0.01mm
Kind of fluid	Water
Kinematic viscosity	1.004E-6 m2/s
Sensor mounting	Z
Sensor type	PSX2B
Trans. voltage	x4

Example of system setting list

System setup		
Communication	Baud rate	9600
	Parit	None
	Stop bit	1 bit
System of units		Metric
Measure mode		2
Memory initialize		No

Example of analog list

Analog input/output		
Input	Input range	1.000 E2
Output	Range unit	m3/h
	Output range	4.000 E1
	Output mode	0.8-4-20mA
	Burn-out	Hold

9.5.3 Setting of print time

(1) To print out continuously

- ① Press the ▲ or ▼ key on the PRINTER page, select “TIMER MODE” and press the ENT key. The TIMER MODE screen is displayed.

The screenshot shows the PRINTER screen with the following content:

MODE TEXT	
UNIT	FLOW RATE
	OFF
	+TOTAL OFF
	-TOTAL OFF
	ANALOG IN OFF
TIMER MODE	MANUAL
SAMPLING PERIOD	00:01
PRINT OUT	

- ② Use the ▲ or ▼ key to select “MANUAL” and press the ENT key.

The screenshot shows the PRINTER screen with the following content:

MODE TEXT	
UNIT	FLOW RATE
	OFF
	OFF
	OFF
	OFF
TIMER MODE	MANUAL
QUICK TIMER	00:30
TIMER	
TIMER MODE	MANUAL
SAMPLING PERIOD	00:01
PRINT OUT	

- ③ To select printing, select “PRINT OUT” and press the ENT key.

The screenshot shows the PRINTER screen with the following content:

MODE TEXT	
UNIT	FLOW RATE
	OFF
	OFF
	OFF
	OFF
TIMER MODE	MANUAL
SAMPLING PERIOD	00:01
PRINT OUT	

To start printing, select “PRINT OUT” and press the ENT key.

(2) Short-time printing

- ① Press the ▲ or ▼ key on the PRINTER page. Select "TIMER" and press the (ENT) key. The Timer Mode screen is displayed.

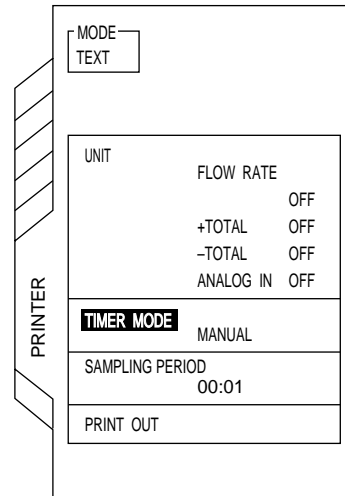

- ② Press the ▲ or ▼ key to select "QUICK TIMER" and press the (ENT) key.

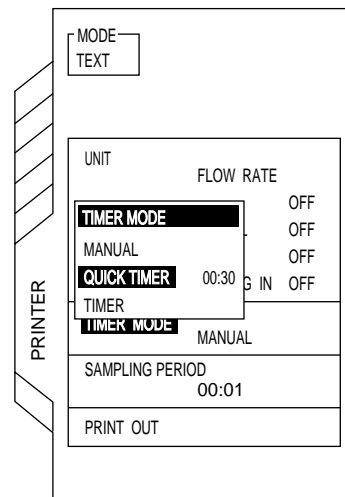

- ③ The TIME selection screen is displayed. Press the ▲ or ▼ key to select the printing time.
- ④ Press the (ENT) key, and the setting is now completed. Then, press the (ESC) key to return to the previous screen.
- ⑤ Select "PRINT OUT" and press the (ENT) key. Printing is continued until the selected time passes and is stopped.

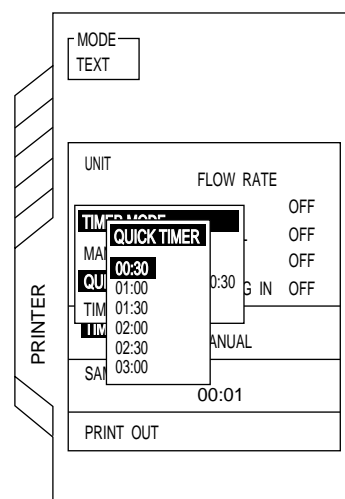

Example) Select 00:30 on the TIME selection screen and press the (ENT) key. Select "PRINT OUT" and press the (ENT) key. Then, printing will be started and stopped in 30 minutes.

(3) To print after the start and stop times are set

- ① Press the ▲ or ▼ key on the PRINTER page, select “TIMER MODE” and press the ENT key. The Timer Mode screen is displayed.

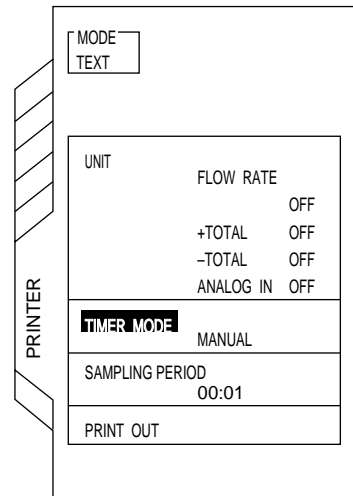

- ② Select “TIMER MODE” by pressing the ▲ or ▼ key and press the ENT key.

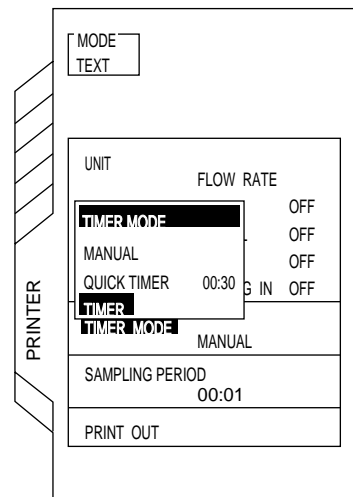

- ③ The Timer Setup screen is displayed. Press the ENT key, and you are ready to set “START DATE/TIME”.

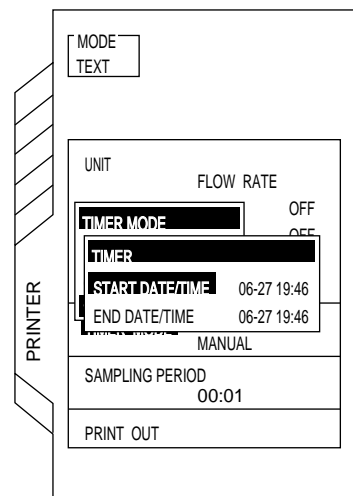

- ④ Move the digit by the ◀ or ▶ key and enter a numeric value by the ▲ or ▼ key. Press the **ENT** key to set the start time.

Example) when starting on 06-27 20: 00
(June 27, 20: 00)

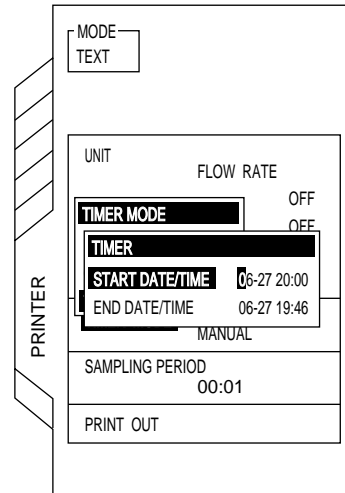

- ⑤ The screen is in a state of setting “END DATE/TIME” by pressing the ▼ key. Set the end time in the same manner as in the “START DATE/TIME” settings.

Example) when stopping on 06-27 23: 00
(June 27, 23: 00)

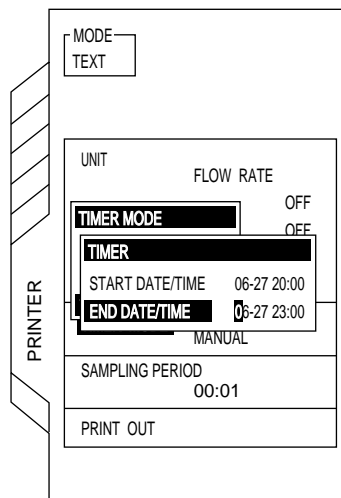

- ⑥ Press the **ESC** key 2 times to return to the screen shown at right.
- ⑦ Select “PRINT OUT” and press the **ENT** key. Printing will start at the set start time and stop at the set stop time.

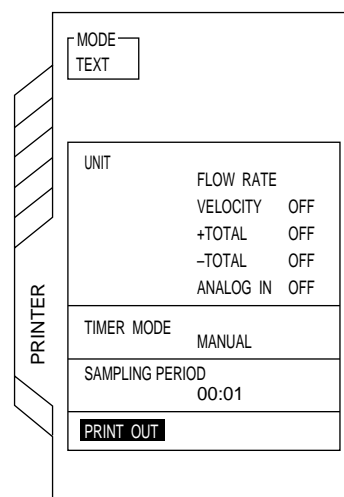

9.5.4 To set printing intervals

- ① Press the ▲ or ▼ key on the PRINT page, select “SAMPLING PERIOD” and press the **ENT** key. The SAMPLING PERIOD screen is displayed.
- ② Move the digit by pressing the ◀ or ▶ key, and enter a numeric value by pressing the ▲ or ▼ key. Press the **ENT** key and set the sampling period.

Setting

In the TEXT mode: 00 : 00
Hour: Minute

In the GRAPH mode: 00 : 00 : 00
Hour: Minute: Second

Example) When printing data in a graph every 20 minutes, set the print period to “00 : 20 : 00”.

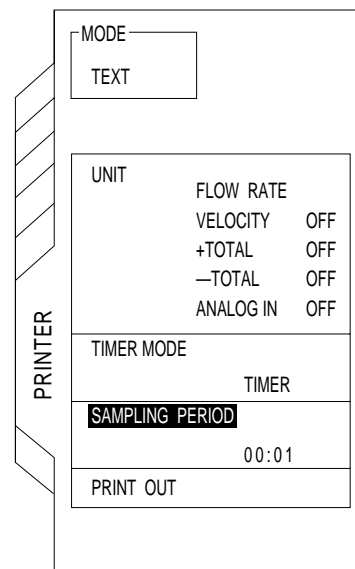

9.5.5 To set graph scale in GRAPH mode

[This setting should be done only when the “GRAPH” mode is set.]

- ① Press the ▲ or ▼ key on the PRINT page, select “LEFT” from “SCALE SET” and press the **ENT** key. The screen is displayed, enabling you to set measured values at LEFT.

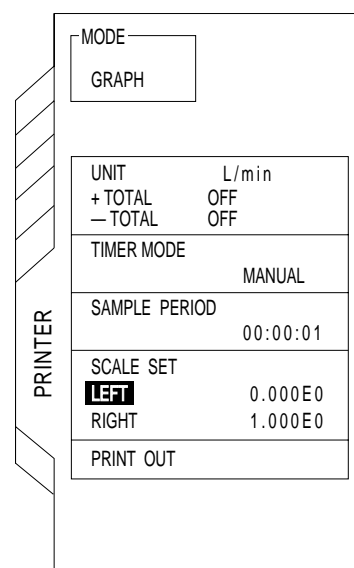

- ② Move the digit by the ◀ or ▶ key and enter a numeric value by the ▲ or ▼ key.
Press the **ENT** key to set measured value at LEFT.
- ③ Press the ▼ key to set “RIGHT”.
- ④ Set RIGHT in the same manner as in “LEFT”.
- ⑤ Press the **ENT** key to return to the previous screen.

9.5.6 Printing

Press the ▲ or ▼ key to select the “PRINT OUT”.
 Press the ENT key to start printing.

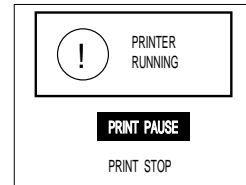
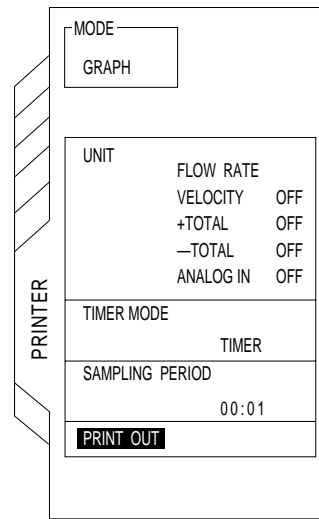

9.5.7 Printing stop

(1) To pause printing

- ① To cause printing to pause when printing, move the cursor to “PRINT PAUSE” and press the ENT key. When starting printing again, move the cursor to “CONTINUE” and press the ENT key.

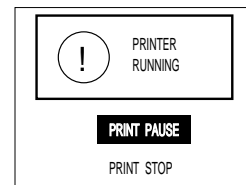
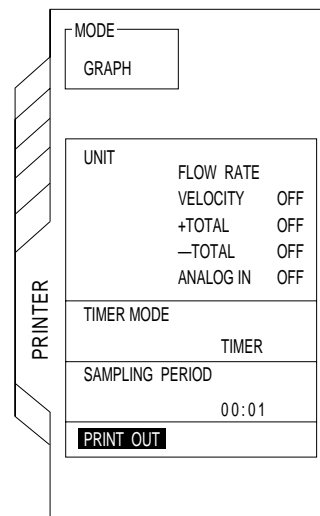

(2) To stop printing

- ① To stop printing when printing, move the cursor to “PRINT STOP” and press the ENT key. Printing is stopped.

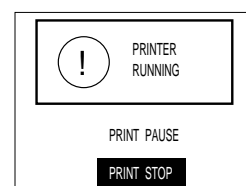

9.6 System check function (SYSTEM CHECK page)

This function allows you to check the condition of this instrument. If an error occurs, take countermeasures according to chapter 11, "ERROR AND REMEDY".

9.6.1 ERROR CHECK

When an error is detected on MEASURE screen

- ① Move the cursor to "ERROR CHECK" on the SYSTEM CHECK page and press the **(ENT)** key. The ERROR CHECK screen is displayed.

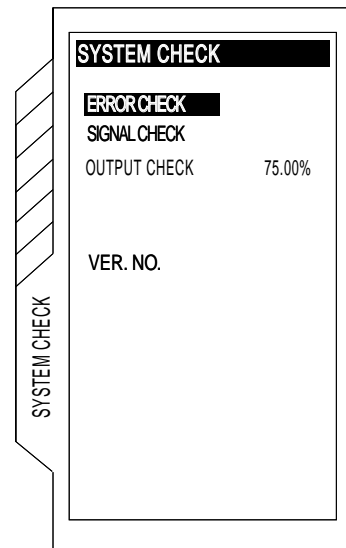

- ② Select error items displayed on the MEASURE screen by pressing the **(▲)** or **(▼)** key.

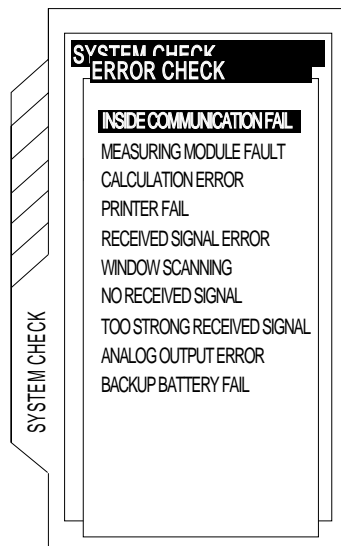

- ③ Press the **(ENT)** key, and the countermeasure against error screen is displayed.

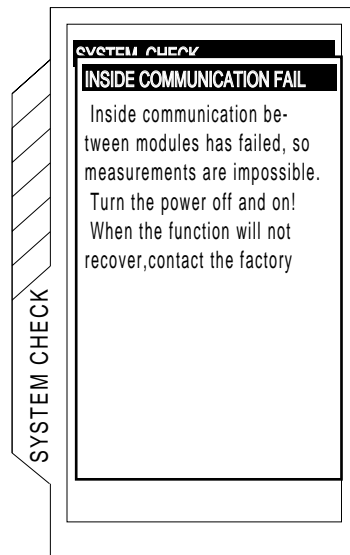

Countermeasures against error screen

① INSIDE COMMUNICATION FAIL

SYSTEM CHECK

SYSTEM CHECK

INSIDE COMMUNICATION FAIL

Inside communication between modules has failed, so measurements are impossible.
Turn the power off and on!
When the function will not recover, contact the factory

② MEASURING MODULE FAULT

SYSTEM CHECK

SYSTEM CHECK

MEASURING MODULE FAULT

Measuring has not acted correctly.
Turn the power off and on!
When the function will not recover, contact the factory.

③ CALCULATION ERROR

SYSTEM CHECK

SYSTEM CHECK

CALCULATION ERROR

Calculated parameters for flowrate measurement are not correct.
Recheck the set data!
Turn the power off and on!
When the function will not recover, contact the factory.

④ PRINTER FAIL

SYSTEM CHECK

SYSTEM CHECK

PRINTER FAIL

Printer unit has failed, so it cannot start printing.
Check whether paper jam or not!
Check if the connection to the converter is correct.
Turn the power switches of converter and printer unit off and on!
When the function will not recover, contact the factory.

⑤ RECEIVED SIGNAL ERROR

SYSTEM CHECK

SYSTEM CHECK

RECEIVED SIGNAL ERROR

The strength of received signals is changing so frequently that measurements are impossible!
Check if many bubbles or solid particles are contained in measured fluid!
If so, reduce them to be measurable, otherwise change the mounting site of the detector to other places.

⑥ WINDOW SCANNING

SYSTEM CHECK

SYSTEM CHECK

WINDOW SCANNING

There is no signal within the measuring window.
Therefore the measuring window is being scanned to search signal wave.

⑦ NO RECEIVED SIGNAL

SYSTEM CHECK

SYSTEM CHECK

NO RECEIVED SIGNAL

Received signals are so poor that measurements are impossible.
Recheck the set data, especially pipe parameters and sensor mounting method!
Check the sensor spacing, and the connection between converter and detector!
Otherwise set the transmission voltage higher.

⑧ TOO STRONG RECEIVED SIGNAL

SYSTEM CHECK

SYSTEM CHECK

TOO STRONG RECEIVED SIGNAL

Received signals are so strong that measurements are impossible.
Change the mounting method of the detector from Z to V!

⑨ ANALOG OUTPUT ERROR

SYSTEM CHECK

SYSTEM CHECK

ANALOG OUTPUT ERROR

Magnitude of analog output exceeds the scale range.
Change the scale!

⑩ BACKUP BATTERY FAIL

SYSTEM CHECK

SYSTEM CHECK

BACKUP BATTERY FAIL

Backup battery for set data and logging data has failed.
Contact the factory for exchange!
Be careful that the data will fail if you turn the power off!
Be careful that this fail information will disappear if you press the ESC key!

9.6.2 SIGNAL CHECK

(1) To check for ultrasonic receiving signal waveform;

- ① Move the cursor to “SIGNAL CHECK” on the SYSTEM CHECK page and press the **(ENT)** key, and the Receiving Signal Waveform screen is displayed.

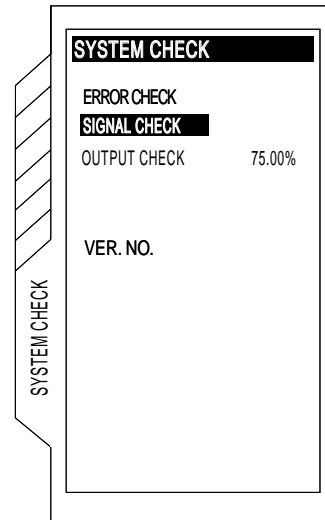

- ② Move the cursor to “SOURCE” by pressing the **(▲)** or **(▼)** key as shown at right and press the **(◀)** or **(▶)** key to select either of waveforms (upstream and downstream).

Displays the sound velocity of fluid to be measured.
Measures in real time.

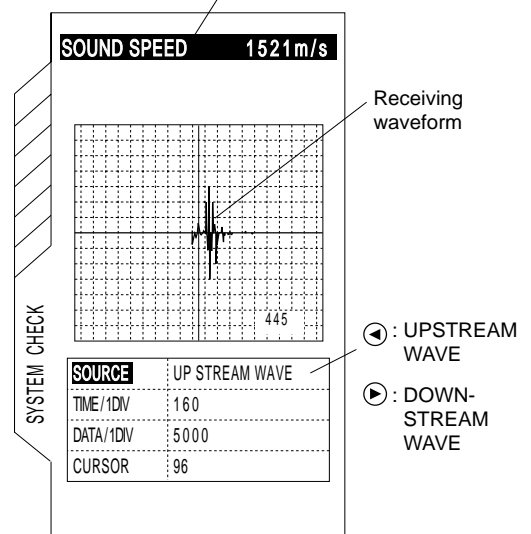

- ③ Move the cursor to “CURSOR” by pressing the **(▲)** or **(▼)** key as shown at right and press the **(◀)** or **(▶)** key to move the cursor to a receiving signal waveform-like point.

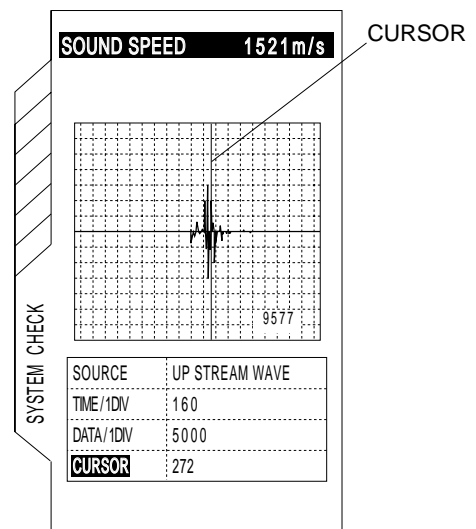

- ④ Move the cursor to “TIME/1 DIV” by pressing the ▲ or ▼ key as shown at right and enlarge the scale of the time axis (horizontal axis) by the ◀ key. (Magnifying power is 10, 20, 40, 80, and 160 times).

To contract the scale after enlargement, press the ▶ key.

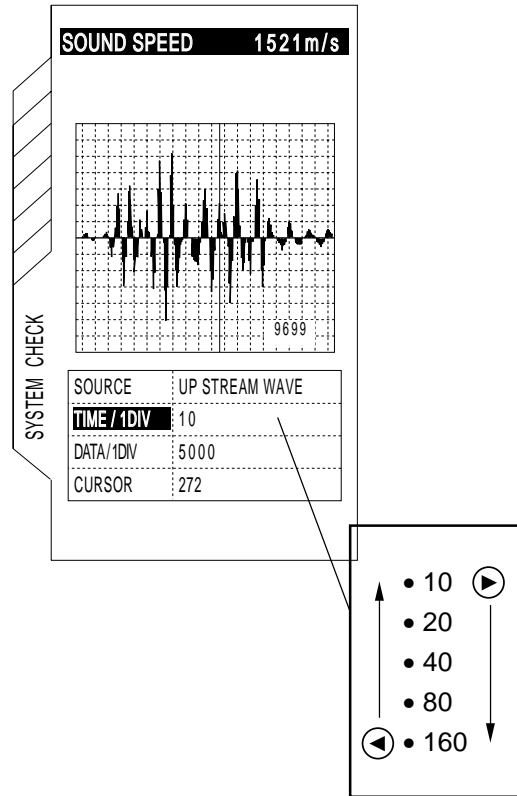

- ⑤ Move the cursor to “DATA/1 DIV” and enlarge the scale of the data axis (vertical axis) by the ▶ key. (Magnifying power is 10, 100, 100, 1000, 5000 and 10000 times). To contract the scale after enlargement, press the ◀ key.

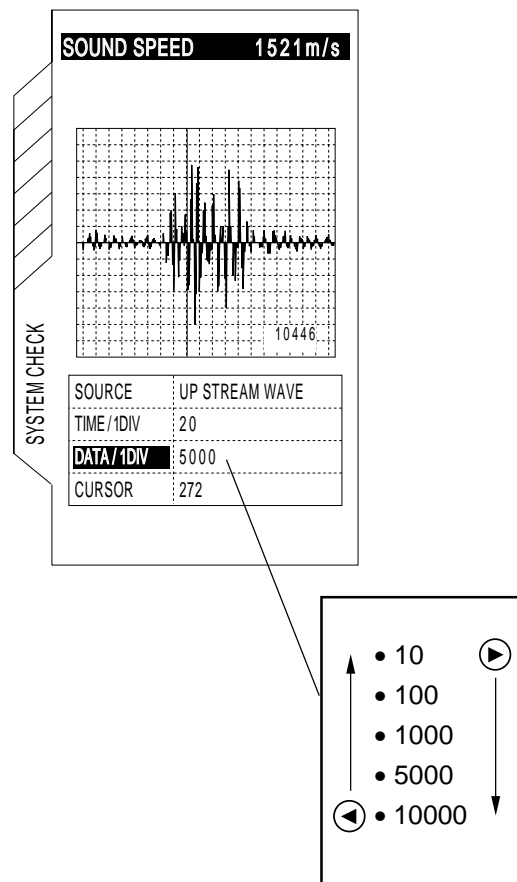

(2) Check to judge whether ultrasonic receiving signal waveform is normal or not

① Normal waveform

The receiving waveform above is free of noise, and so normal measurement is allowed.

Peak value of about 15000 to 20000

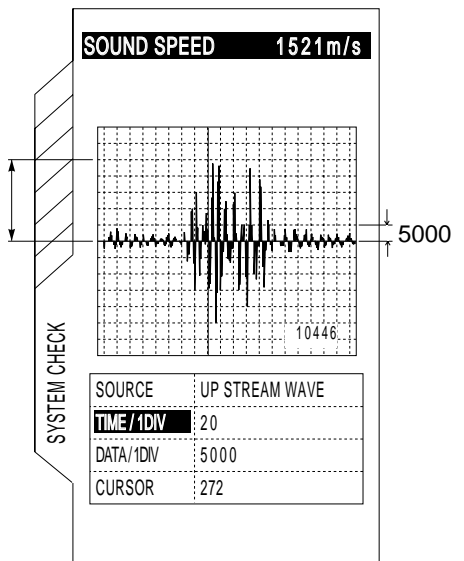

② Abnormal waveform

The above receiving waveform is not covered within the range of the ultrasound waveform. It is displayed as “CALCULATION ERROR” or “RECEIVED SIGNAL ERROR”.

Check the pipe setting and sensor mounting dimensions.

When ultrasonic receiving signal waveform is weakened by the effect of rust in the pipe, abnormal waveform may result. Raise the transmission voltage and perform measurement. (See page 6-12).

Receiving waveform is cut off.

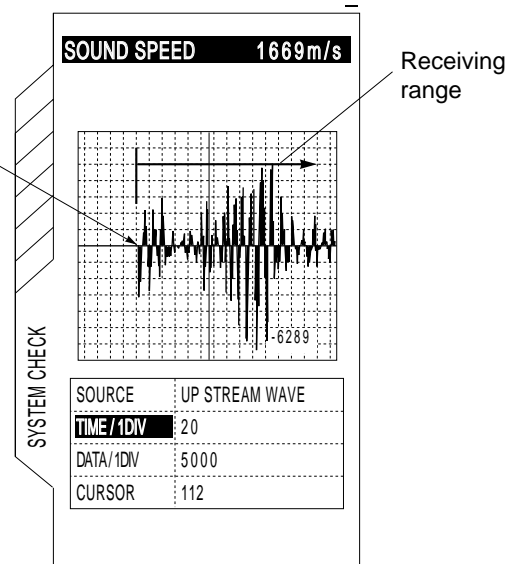

Receiving range

9.6.3 OUTPUT CHECK

when performing the setting of constant current output (available for loop check or to check for the power supply output circuit of this instrument)

- ① Move the cursor to “OUTPUT CHECK” on the SYSTEM CHECK page and press the **(ENT)** key. The OUTPUT CHECK screen is displayed, enabling you to perform the constant current output settings.

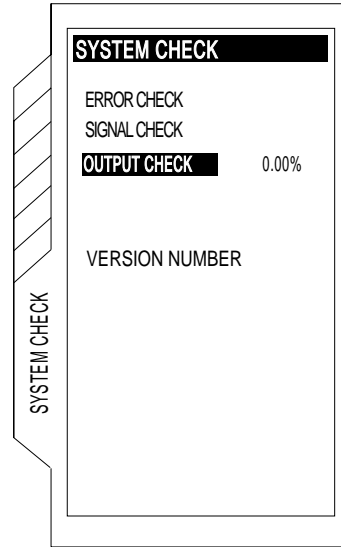

- ② Move the digit by the **(←)** or **(→)** key, enter a numeric value by the **(▲)** or **(▼)** key and then press the **(ENT)** key, and the constant current output settings can be accomplished. (range: -20.0% to 120.0%)

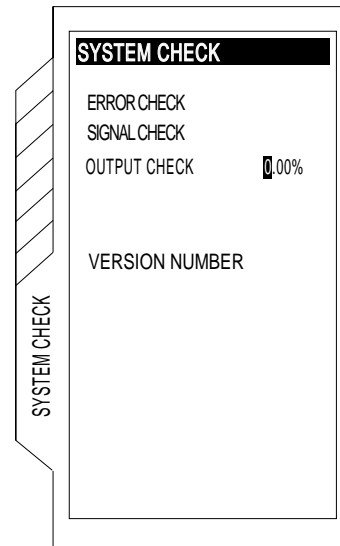

9.6.4 VERSION NUMBER

To check the current version of software, move the cursor to “VERSION NUMBER” on the SYSTEM CHECK page and press the **(ENT)** key.

(Example)

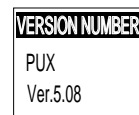

10. MAINTENANCE AND CHECKUP

(1) Cleaning of converter and detector

Wipe off contamination, dust, etc. from the keyboard and main frame of the converter unit occasionally with soft cloth or the like. If contaminants cannot be removed by wiping with dry cloth, moisten cloth with water, wring it adequately and wipe again.

Before accommodating the converter in the carrying case after use, wipe off grease completely.

Note) Do not use volatile agents such as benzine and paint thinner for cleaning.

(2) When instrument unused

Put the instrument in the furnished carrying case and store it at a place which meets the following conditions.

- Not exposed to direct sunlight, rain, etc.
- Free from extremely high temperature and humidity (away from a heater)
Storage temperature: -10 to 45°C
- Absence of excessive dust and other contaminants.

(3) Replacement of memory backing battery

In normal usage, the battery has a service life of about 5 years.

When the battery has reached the end of its service life, the data stored in memory will all be lost.

For replacement, contact Dwyer Instruments.

(4) Replacement of LCD

LCD has a lifetime of 5 years or longer when used continuously. When display becomes difficult to be read or the backlight does not come on, the LCD should be replaced with a new one.

For replacement, contact Dwyer Instruments.

(5) Replacement of built-in battery

The built-in battery can be charged up to about 500 times.

If it cannot be charged, it is an indication that the battery life is terminated and it needs to be replaced.

For replacement, be sure to use the battery specified by Dwyer Instruments.





(6) Replacement of printer roll-paper

When roll-paper is used for panel copy (hard copy), up to about 181 panels can be printed. When a red band appears on the roll-paper, it is an indication that little paper is left for printing. Replace with new one (OEM or equivalent: SEIKO Instruments; P/N: TP080-20LJ1).

11. ERROR AND REMEDY

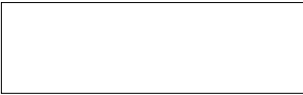
11.1 Error in LCD Display

If an error occurs, refer to Table below.

Status	Cause	Remedy
 No display appears.	<ul style="list-style-type: none"> • Power supply is not turned on. • Voltage is low. • Fuse has blown. • LCD is abnormal. • Connection of DC power supply is reverse in polarity. 	⇨ See section 10 (4) "Replacement of LCD"
 Irrational display	<ul style="list-style-type: none"> • Hardware error 	
 Display is not clear.	<ul style="list-style-type: none"> • Ambient temperature is high (50° or higher) • LCD has reached the end of its service life. 	⇨ Lower the temperature. ⇨ Replace the LCD.
 Entire display is blackish.	<ul style="list-style-type: none"> • Line voltage is low. • LCD is abnormal. • Ambient temperature is high (50° or higher) 	⇨ See section 10 (4) "Replacement of LCD" ⇨ Lower the temperature.

11.2 Error of key

No response is made to key input.	<ul style="list-style-type: none"> • Hardware error
Any particular key does not function or functions in a wrong way.	

11.3 Error in measured value

State	Cause	Remedy
Indication of measured value is negative (-).	<ul style="list-style-type: none"> • Connection between the main unit and sensors (upstream sensor and downstream sensor) is reverse. 	⇨ Connect correctly.
	<ul style="list-style-type: none"> • Fluid is actually flowing in the (-) direction. 	
Measured value fluctuated widely though flow rate is constant.	<ul style="list-style-type: none"> • Straight pipe portion is inadequate. 	⇨ Shift measurement location to the site where 10D and 5D can be secured on the upstream and downstream sides.
	<ul style="list-style-type: none"> • A flow disturbing factor such as pump or valve is provided in the vicinity. 	⇨ Mount the instrument with a clearance of 30D or more.
	<ul style="list-style-type: none"> • Pulsation is occurring actually. 	⇨ Extend response time through damping setting.
Measured value remains the same though flow rate is changing.	<ul style="list-style-type: none"> • Measured value is held because ultrasonic wave cannot be propagated into a pipe. <p>1. Incomplete installation</p> <div data-bbox="427 1010 852 1350" style="border: 1px solid black; padding: 5px;"> <ul style="list-style-type: none"> • Piping specifications are wrong. • Sensor is mounted at the welded part. • Sensor mounting dimension is wrong. • Grease application at sensor mounting is incomplete. • Sensor connector is not connected completely. • Pipe surface is contaminated. </div> <p>2. Problem on pipe or fluid</p> <div data-bbox="427 1451 852 1686" style="border: 1px solid black; padding: 5px;"> <ul style="list-style-type: none"> • When V method is used, it should be changed to Z method. • When sensor extension cable is used, it should be avoided. • If error persists, check and eliminate the true cause as instructed below. </div>	⇨ <div data-bbox="938 1122 1313 1272" style="border: 1px solid black; padding: 5px; margin-left: 20px;"> After check, separate the sensor once. Apply the grease again and remount the sensor with a slight shift. </div>
	<p>◎ Fluid is not filled.</p>	⇨ <div data-bbox="938 1742 1313 1951" style="border: 1px solid black; padding: 5px; margin-left: 20px;"> Find the location on the same pipe line, where fluid is filled up and move the sensors to that location. Mount the sensors at the lowest location on pipe line. </div>

State	Cause	Remedy
	<p>⊙ Air bubbles have entered.</p> <p>[In case measurement is normal with water flow stopped, entrance of air bubbles is the cause of this error.] ⇒</p> <p>[When the sensor is mounted just after a valve, cavitation will occur to cause the same effect as entrance of air bubbles.]</p>	<p>Eliminate entrance of air bubbles.</p> <ul style="list-style-type: none"> • Raise the level of pump well. • Confirm the shaft seal of pump. • Retighten the flange of negative pressure piping. • Prevent fluid from rushing into pump well. <hr/> <p>Move the sensor to the location where air bubbles have not entered.</p> <ul style="list-style-type: none"> • To the inlet side of pump • To the upstream side of valve
	<p>⊙ Turbidity is high.</p> <p>[Turbidity is higher than those of sewage and return sludge.] ⇒</p>	<ul style="list-style-type: none"> • Change the sensor mounting method from V to Z. • Move the sensor to the location on the same line, where the outer diameter of pipe is smaller. • Move to a different place or different pipe. • Raise the voltage for transmission (refer to p.6-12).
	<p>⊙ Because of an old pipe, scale has stuck to the inside. ⇒</p>	
	<p>⊙ Lining is thick.</p> <p>[Because of mortar lining or the like, thickness is a few ten mm or more.] ⇒</p>	<p>Try measurement with the optional large size sensor.</p> <p>⇒ Contact Dwyer Instruments</p>
	<p>⊙ Lining is peeled.</p> <p>[There is a gap between lining and piping.] ⇒</p>	
	<p>⊙ Sensor is mounted at a bent pipe or tapered pipe. ⇒</p>	<p>Mount to a straight pipe.</p>
	<p>3. Influence by external noise ⇒</p> <p>[• There is a radio broadcasting station in the vicinity. • Measurement has been conducted near heavy traffic.]</p>	<ul style="list-style-type: none"> • Minimize the cable between main unit and sensors.
	<ul style="list-style-type: none"> • Sensor mounting is incomplete. ⇒ • Mounting dimension is improper. • Sensor is not in contact with pipe. 	<p>Mount the sensors in parallel with the pipe following the correct mounting dimension. Bring the sensor in close contact with the pipe.</p>
	<p>4. Hardware error ⇒</p>	<p>Contact Dwyer Instruments</p>

State	Cause	Remedy
<p>Measured value is not zero though water flow has stopped.</p>	<ul style="list-style-type: none"> • Water is subjected to convection in a pipe. ⇒ • Zero adjustment has been performed. ⇒ • When water flow stops, pipe is not filled up with water or becomes empty. ⇒ 	<div style="border: 1px solid black; padding: 5px; margin-bottom: 5px;">Normal</div> <ul style="list-style-type: none"> • Perform zero adjustment again after making sure water flow has stopped completely. • The measured value, just when ultrasonic wave cannot be propagated, is held. ⇒ Normal
<p>Measured value has an error.</p>	<ul style="list-style-type: none"> • Input piping specifications are different from actual ones. ⇒ • Because of an old pipe, scale has stuck. ⇒ ◎ The length of straight pipe portion is inadequate. ⇒ <div style="border: 1px solid black; padding: 5px; margin: 5px 0;"> <p>10D and 5D are required at least on the upstream and downstream sides. Flow disturbing element should not be present within 30D on upstream side. Pump, valve, flow joining pipe or the like is unallowable.</p> </div> <ul style="list-style-type: none"> • Pipe is not filled with water or mud and sand have precipitated. ⇒ 	<div style="border: 1px solid black; padding: 5px; margin-bottom: 5px;"> <ul style="list-style-type: none"> • A difference of 1% in inner diameter causes an error of about 3%. <p style="text-align: center;">↓</p> <ul style="list-style-type: none"> • Input specifications correctly. • Input scale as lining. </div> <div style="border: 1px solid black; padding: 5px; margin-bottom: 5px;"> <p>Select a different location of sensor mounting (move the upstream side of a flow disturbing element).</p> </div> <div style="border: 1px solid black; padding: 5px; margin-bottom: 5px;"> <ul style="list-style-type: none"> • Mount the sensor at different angles with respect to the cross section of pipe to find the location where mean value is obtainable. The mount the sensor at that location. </div> <div style="border: 1px solid black; padding: 5px;"> <p>Precipitation is more when the cross section of pipe has a smaller area.</p> <p style="text-align: center;">↓</p> <p>Shift the sensor to the vertical portion of pipe.</p> </div>

11.4 Error in analog output

State	Cause	Remedy
Output remains at 4mA though indication value is other than 0.	⊙ Analog span setting has not been made.	⇒ Set the span. Otherwise, output remains at 4mA.
Output is 0mA.	⊙ Cable is broken.	Repair
Output is not 4mA when indication value is 0.	⊙ The zero point of analog output is not adjusted properly.	⇒ Calibrate analog output.
Output rises beyond 20mA.	⊙ Indication value is larger than analog span value. ⊙ Span is deviated.	⇒ Overshoot Set analog span again. Calibrate analog output.
Analog output remains the same despite change in indication value.	⊙ Output load is larger than 1kΩ.	⇒ Permissible load is 1kΩ. Reduce the load to less than 1kΩ.
Indication value does not match analog output.	• Zero point and span of analog output are deviated.	⇒ Calibrate analog output.
Output remains the same even after calibration of analog output.	• Hardware error	⇒ Contact Dwyer Instruments

11.5 Display of error

State	Cause	Remedy
"BACKUP BATTERY FAIL" is displayed on measurement panel.	⊙ Memory data are all cleared.	⇒ Select the error check item "BACKUP BATTERY FAIL" using the system check page to display the data of processing the error, and then perform the following operation on the measurement panel. • When "BACKUP BATTERY FAIL" is released, set measurement conditions. • When "BACKUP BATTERY FAIL" is not released, the memory backup battery needs to be replaced. ⇒ Contact Dwyer Instruments
"INSIDE COMMUNICATION FAIL" is displayed on the measurement panel.	• Hardware error	⇒ Contact Dwyer Instruments.
For other errors, refer to the "ERROR CHECK" screen (9.6.1, "ERROR CHECK").		

12. SPECIFICATIONS FOR SERIAL TRANSMISSION (RS-232C)

(1) General specifications

Communication system : Half-duplex
 Synchronizing system : Start-stop synchronizing
 Transmission speed : 300 / 600 / 1200 / 2400 / 4800 / 9600 bps (selectable)
 Parity : Even/odd number / None (selectable)
 Data length : 8 bits
 Stop bit : 1 bit / 2 bits (selectable)
 Data code : ASCII
 Insulation : Non-insulation between transmission line and converter (see chapter 12 (3)).

(2) Interface specifications

Electric characteristic : Based on EIA RS-232C
 Connection signal :

Pin No.	Signal name	Meaning	Signal direction
2	RxD	Receive data	Input
3	TxD	Send data	Output
4	DTR	Data terminal relay	(Not used)
5	GND	Signal ground	
6	DSR	Data set ready	(Not used)
7	RTS	Request to send	(Not used)
8	CTS	Clear to send	(Not used)

Cable length : 15m or less
 Connector : D-SUB, 9-pin plug
 Connection : 1:1 connection

(3) Composition

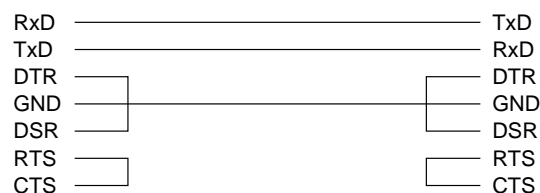
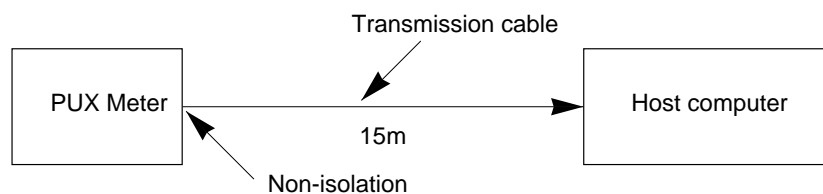

(4) Setting

Transmission speed, parity and stop bit should be set prior to transmission.

Set values before setting.

Transmission speed : 300 bps
 Parity : None
 Stop bit : 1 bit

[Note] After setting, the set data in memory are backed up by built-in battery.

(5) Communication control

① Method

Transmission of data with flow transmitter is made according to request command from host computer.

When a command is received from host computer, the data corresponding to the command is transmitted from Portaflow to the host computer.

② Commands

Commands with ASCII code are transmitted from host computer to flow transmitter.

The last code of 1 command is carriage return (0DH).

[Portaflow RS-232C Transmission Command Table]

Real time transmission

Command	Data	Data format (example)
DQ01 [CR]	Instantaneous flow (L/s or gal/s)	<input type="checkbox"/> 1.000E + 3 <input type="checkbox"/> <input type="checkbox"/> L/s [CR] [CR]
DQ02 [CR]	Instantaneous flow (L/min or gal/min)	<input type="checkbox"/> 1.000E + 3 <input type="checkbox"/> <input type="checkbox"/> L/min [CR] [CR]
DQ03 [CR]	Instantaneous flow (L/h or gal/h)	<input type="checkbox"/> 1.000E + 3 <input type="checkbox"/> <input type="checkbox"/> L/h [CR] [CR]
DQ04 [CR]	Instantaneous flow (ML/d or Mgal/d)	<input type="checkbox"/> 1.000E + 3 <input type="checkbox"/> <input type="checkbox"/> ML/d [CR] [CR]
DQ05 [CR]	Instantaneous flow (m ³ /s or ft ³ /s)	<input type="checkbox"/> 1.000E + 3 <input type="checkbox"/> <input type="checkbox"/> m ³ /s [CR] [CR]
DQ06 [CR]	Instantaneous flow (m ³ /min or ft ³ /min)	<input type="checkbox"/> 1.000E + 3 <input type="checkbox"/> <input type="checkbox"/> m ³ /min [CR] [CR]
DQ07 [CR]	Instantaneous flow (m ³ /h or ft ³ /h)	<input type="checkbox"/> 1.000E + 3 <input type="checkbox"/> <input type="checkbox"/> m ³ /h [CR] [CR]
DQ08 [CR]	Instantaneous flow (Mm ³ /d or Mft ³ /d)	<input type="checkbox"/> 1.000E + 3 <input type="checkbox"/> <input type="checkbox"/> Mm ³ /d [CR] [CR]
DQ09 [CR]	Instantaneous flow (BBL/s)	<input type="checkbox"/> 1.000E + 3 <input type="checkbox"/> <input type="checkbox"/> BBL/s [CR] [CR]
DQ10 [CR]	Instantaneous flow (BBL/min)	<input type="checkbox"/> 1.000E + 3 <input type="checkbox"/> <input type="checkbox"/> BBL/min [CR] [CR]
DQ11 [CR]	Instantaneous flow (BBL/h)	<input type="checkbox"/> 1.000E + 3 <input type="checkbox"/> <input type="checkbox"/> BBL/h [CR] [CR]
DQ12 [CR]	Instantaneous flow (MBBL/d)	<input type="checkbox"/> 1.000E + 3 <input type="checkbox"/> <input type="checkbox"/> MBBL/d [CR] [CR]
DV [CR]	Instantaneous flow (m/s or ft/s)	<input type="checkbox"/> 32.00E + 1 <input type="checkbox"/> <input type="checkbox"/> m/s [CR] [CR]
DI+ [CR]	Normal direction integration flow	+ TOTAL <input type="checkbox"/> 1234567 <input type="checkbox"/> <input type="checkbox"/> mL [CR] [CR]
DI- [CR]	Reverse direction integration flow	- TOTAL <input type="checkbox"/> 0000123 <input type="checkbox"/> <input type="checkbox"/> mL [CR] [CR]
DAO [CR]	Analog output	<input type="checkbox"/> 1.000E + 2 <input type="checkbox"/> Analog <input type="checkbox"/> Out [CR] [CR]
DAI [CR]	Analog input	<input type="checkbox"/> 1.000E + 2 <input type="checkbox"/> Analog <input type="checkbox"/> In [CR] [CR]
DC [CR]	Status	NORMAL [CR] [CR] (output of status comment of up to 20 characters)
DT [CR]	Time	95 - 01 - 05 <input type="checkbox"/> 12 : 00 [CR] [CR]

: space

Space for head of flow rate/velocity () shows (-) at reverse flow.

Data logger transmission

Command	Data	Data format (example)
LF01 [CR] to LF20 [CR]	Output of logger file data of the number designated by command	<pre> No.XX [CR] LOG □ NAME : XX ... XX [CR] START □□□ : 01 - 23 □ 23 : 34 [CR] END□□□□□ :01-24 □ 23 : 12 [CR] INTERVAL: 01: 00:00 [CR] [CR] ----- Data not stored: EMPTY [CR] [CR] ----- Logger sampling: DATA LOGGER SAMPLING [CR] [CR] </pre>
LD01 [CR] to LD20 [CR]	Output of logger data of the number designated by command	<pre> No.XX [CR] LOG□NAME : XX ... XX [CR] START □□□ : 01 - 23 □ 23 : 34 [CR] END □□□□□ :01-24 □ 23 : 34 [CR] INTERVAL: 01: 00:00 [CR] [CR] [CR] 01 - 23 23: 34 : 00 [CR] □ 32.00E + 1 □□m/s [CR] □ 1.000E + 3 □□m3/h [CR] NORMAL [CR] [CR] 01 - 23□00 : 34 : 00 [CR] □ 32.00E + 1 □□m/s [CR] □ 1.000E + 3 □□m3/h [CR] NORMAL [CR] [CR] 01 - 24□23 : 34 : 00 [CR] □ 32.00E + 1 □□m/s [CR] □ 1.000E + 3 □□m3/h [CR] NORMAL [CR] [CR] Note) Data are outputted till the end of it. </pre>

13. HOW TO USE PRINTER

13.1 How to connect printer

- ① Turn off the power supply of main unit.
- ② Detach the top cover of main unit.

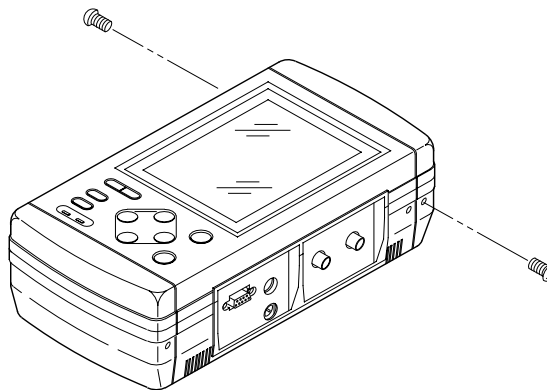

- ③ Attach the printer.

Connect the power cord and hook up the printer to the main unit with the connector.

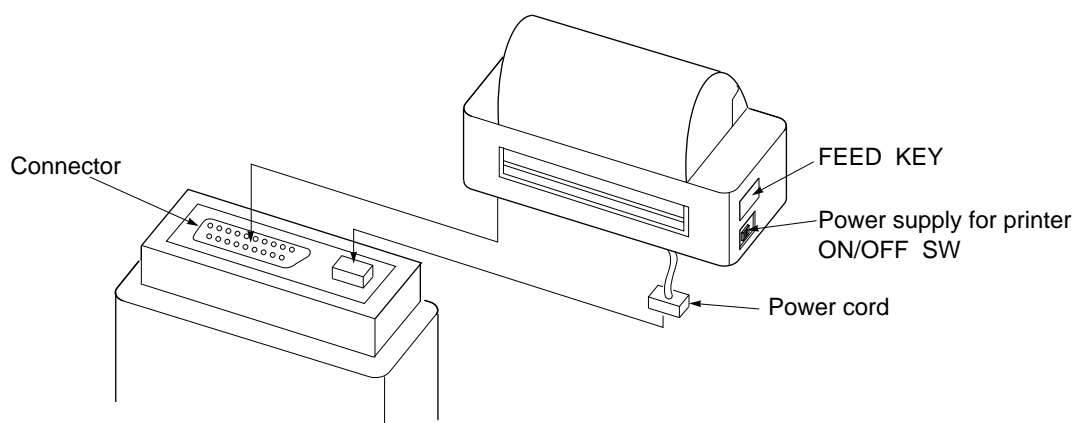

- ④ Fix the printer by tightening the screw (at 2 points) to complete the connection.
- ⑤ Turn ON the power supply of main unit, and then that of the printer.
- ⑥ To feed a paper, press printer FEED key.

13.2 How to load printer roll sheet

- ① Open the cover and load a roll sheet

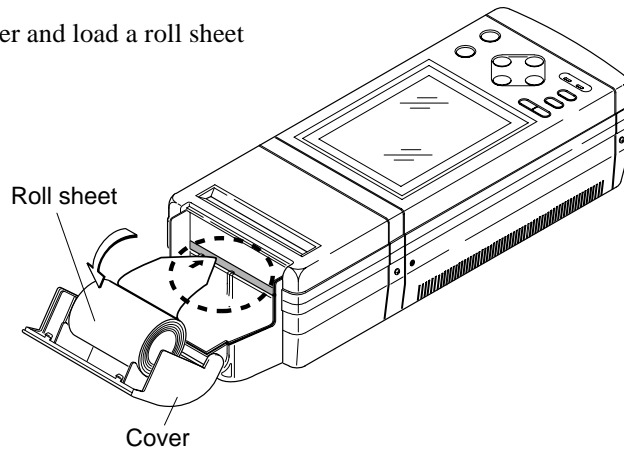

- ② Insert the edge of roll paper into the head assembly.
The edge should be cut in a triangle for ease of insertion.

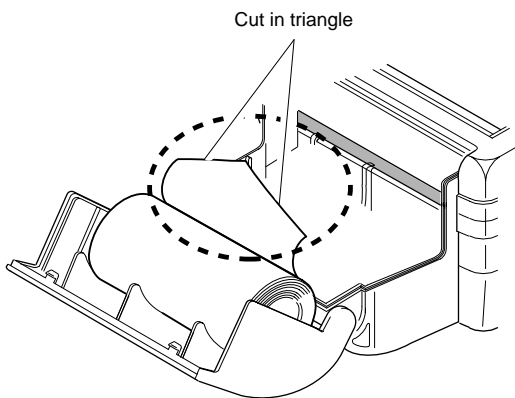

CAUTION

Don't pull the sheet oppositely in the FEED direction, or printer trouble may result.

- ③ Pull the roll sheet appearing at the printer outlet or feed the roller sheet by using the printer FEED key.

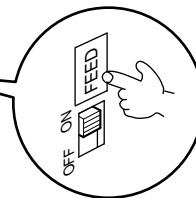
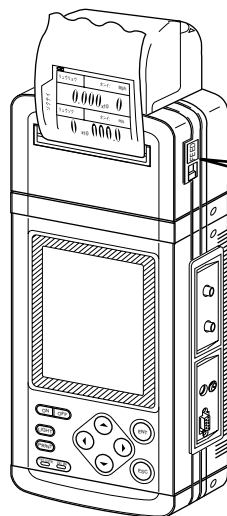

A sheet is only fed by one line every time the FEED key is pressed.

14. REPLACEMENT OF BUILT-IN BATTERY

- ① Remove 2 round countersunk screws (M3 × 5) and remove the cover from the main unit.
- ② Remove the battery connector, pull the battery out of the main unit, and replace it with a new one.

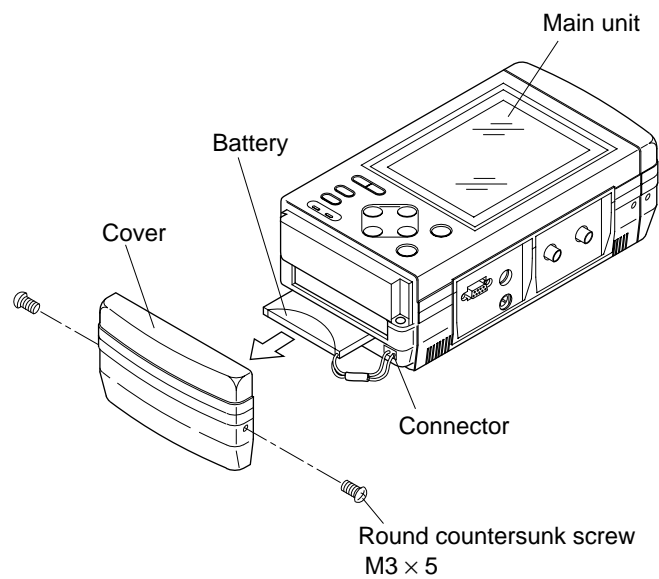

15. APPENDIX

15.1 Piping data

① Stainless steel pipe for pipe arrangement(JIS G3459-1997)

Note) For outer diameter and thickness of pipes, enter actual size.

Nominal diameter (mm)		Outer diameter (mm)	Nominal thickness						
			Schedule 5S	Schedule 10S	Schedule 20S	Schedule 40	Schedule 80	Schedule 120	Schedule 160
A	B		Thickness (mm)	Thickness (mm)	Thickness (mm)	Thickness (mm)	Thickness (mm)	Thickness (mm)	Thickness (mm)
15	1/2	21.7	1.65	2.1	2.5	2.8	3.7	—	4.7
20	3/4	27.2	1.65	2.1	2.5	2.9	3.9	—	5.5
25	1	34.0	1.65	2.8	3.0	3.4	4.5	—	6.4
32	1 1/4	42.7	1.65	2.8	3.0	3.6	4.9	—	6.4
40	1 1/2	48.6	1.65	2.8	3.0	3.7	5.1	—	7.1
50	2	60.5	1.65	2.8	3.5	3.9	5.5	—	8.7
65	2 1/2	76.3	2.1	3.0	3.5	5.2	7.0	—	9.5
80	3	89.1	2.1	3.0	4.0	5.5	7.6	—	11.1
90	3 1/2	101.6	2.1	3.0	4.0	5.7	8.1	—	12.7
100	4	114.3	2.1	3.0	4.0	6.0	8.6	11.1	13.5
125	5	139.8	2.8	3.4	5.0	6.6	9.5	12.7	15.9
150	6	165.2	2.8	3.4	5.0	7.1	11.0	14.3	18.2
200	8	216.3	2.8	4.0	6.5	8.2	12.7	18.2	23.0
250	10	267.4	3.4	4.0	6.5	9.3	15.1	21.4	28.6
300	12	318.5	4.0	4.5	6.5	10.3	17.4	25.4	33.3
350	14	355.6	—	—	—	11.1	19.0	27.8	35.7
400	16	406.4	—	—	—	12.7	21.4	30.9	40.5
450	18	457.2	—	—	—	14.3	23.8	34.9	45.2
500	20	508.0	—	—	—	15.1	26.2	38.1	50.0
550	22	558.8	—	—	—	15.9	28.6	41.3	54.0
600	24	609.6	—	—	—	17.5	31.0	46.0	59.5
650	26	660.4	—	—	—	18.9	34.0	49.1	64.2

② Polyethylene double-layer pipe for city water (JIS K6762-1982)

Nominal diameter (mm)	Outer diameter (mm)	Ist type (Soft pipe)	2nd type (Hard pipe)
		Thickness (mm)	Thickness (mm)
13	21.5	3.5	2.5
20	27.0	4.0	3.0
25	34.0	5.0	3.5
30	42.0	5.5	4.0
40	48.0	6.5	4.5
50	60.0	8.0	5.0

③ Galvanized steel pipe for city water SGPW (JIS G3442-1997)

Nominal pipe		Outer diameter (mm)	Thickness (mm)
(A)	(B)		
15	1/2	21.7	2.8
20	3/4	27.2	2.8
25	1	34.0	3.2
32	1 1/4	42.7	3.5
40	1 1/2	48.6	3.5
50	2	60.5	3.8
65	2 1/2	76.3	4.2
80	3	89.1	4.2
90	3 1/2	101.6	4.2
100	4	114.3	4.5
125	5	139.8	4.5
150	6	165.2	5.0
200	8	216.3	5.8
250	10	267.4	6.6
300	12	318.5	6.9

④ Polyethylene pipe for general use (JIS K6761-1998)

Nominal diameter (mm)	Outer diameter (mm)	Ist type (Soft pipe)	2nd type (Hard pipe)
		Thickness (mm)	Thickness (mm)
13	21.5	2.7	2.4
20	27.0	3.0	2.4
25	34.0	3.0	2.6
30	42.0	3.5	2.8
40	48.0	3.5	3.0
50	60.0	4.0	3.5
65	76.0	5.0	4.0
75	89.0	5.5	5.0
100	114	6.0	5.5
125	140	6.5	6.5
150	165	7.0	7.0
200	216	8.0	8.0
250	267	9.0	9.0
300	318	10.0	10.0

⑤ Asbestos cement pipe for city water (JIS A5301-1971)

Nominal diameter (mm)	1st type		2nd type		3rd type		4th type	
	Thickness of connected portion (mm)	Outer diameter of connected portion (mm)	Thickness of connected portion (mm)	Outer diameter of connected portion (mm)	Thickness of connected portion (mm)	Outer diameter of connected portion (mm)	Thickness of connected portion (mm)	Outer diameter of connected portion (mm)
50	10	70	—	—	—	—	—	—
75	10	95	—	—	—	—	—	—
100	12	124	10	120	9	118	—	—
125	14	153	11	147	9.5	144	—	—
150	16	182	12	174	10	170	—	—
200	21	242	15	230	13	226	11	222
250	23	296	19	288	15.5	281	12	274
300	26	352	22	344	18	336	14	328
350	30	410	25	400	20.5	391	16	382
400	35	470	29	458	23	446	18	436
450	39	528	32	514	26	502	20	490
500	43	586	35	570	28.5	557	22	544
600	52	704	42	684	34	668	26	652
700	—	—	49	798	39	778	30	760
800	—	—	56	912	44	888	34	868
900	—	—	—	—	49	998	38	976
1000	—	—	—	—	54	1108	42	1084
1100	—	—	—	—	59	1218	46	1192
1200	—	—	—	—	65	1330	50	1300
1300	—	—	—	—	73	1496	57	1464
1500	—	—	—	—	81	1662	63	1626

⑥ Size of centrifugal sand cast iron pipe (JIS G5522)

Nominal diameter D	Pipe thickness T			Actual outer diameter D ₂
	High pressure pipe	Nominal pressure pipe	Low pressure pipe	
75	9.0	7.5	—	93.0
100	9.0	7.5	—	118.0
125	9.0	7.8	—	143.0
150	9.5	8.0	7.5	169.0
150	9.5	8.0	7.5	169.0
200	10.0	8.8	8.0	220.0
250	10.8	9.5	8.4	271.6
300	11.4	10.0	9.0	322.8
350	12.0	10.8	9.4	374.0
400	12.8	11.5	10.0	425.6
450	13.4	12.0	10.4	476.8
500	14.0	12.8	11.0	528.0
600	—	14.2	11.8	630.8
700	—	15.5	12.8	733.0
800	—	16.8	13.8	836.0
900	—	18.2	14.8	939.0

⑦ Rigid PVC pipe for city water (JIS K6742-1999)

Nominal diameter	Outer diameter	Thickness of pipe
13	18.0	2.5
20	26.0	3.0
25	32.0	3.5
30	38.0	3.5
40	48.0	4.0
50	60.0	4.5
75	89.0	5.9
100	114.0	7.1
150	165.0	9.6

⑧ Vertical cast iron pipe (JIS G5521)

Nominal pipe D	Thickness		Actual outer diameter D ₁
	T		
	Nominal pressure pipe	Low pressure pipe	
75	9.0	—	93.0
100	9.0	—	118.0
150	9.5	9.0	169.0
200	10.0	9.4	220.0
250	10.8	9.8	271.6
300	11.4	10.2	322.8
350	12.0	10.6	374.0
400	12.8	11.0	425.6
450	13.4	11.5	476.8
500	14.0	12.0	528.0
600	15.4	13.0	630.8
700	16.5	13.8	733.0
800	18.0	14.8	836.0
900	19.5	15.5	939.0
1000	22.0	—	1041.0
1100	23.5	—	1144.0
1200	25.0	—	1246.0
1350	27.5	—	1400.0
1500	30.0	—	1554.0

⑨ Hard vinyl chloride pipe (JIS K6741-1999)

Section Nominal diameter (mm)	VP		VU	
	Outer diameter	Thickness	Outer diameter	Thickness
13	18	2.2	—	—
16	22	2.7	—	—
20	26	2.7	—	—
25	32	3.1	—	—
30	38	3.1	—	—
40	48	3.6	48	1.8
50	60	4.1	60	1.8
65	76	4.1	76	2.2
75	89	5.5	89	2.7
100	114	6.6	114	3.1
125	140	7.0	140	4.1
150	165	8.9	165	5.1
200	216	10.3	216	6.5
250	267	12.7	267	7.8
300	318	15.1	318	9.2
350	—	—	370	10.5
400	—	—	420	11.8
450	—	—	470	13.2
500	—	—	520	14.6
600	—	—	630	17.8
700	—	—	732	21.0
800	—	—	835	23.9

⑩ Carbon steel pipe for pipe arrangement (JIS G3452-1997)

Nominal pipe		Outer diameter (mm)	Thickness (mm)
(A)	(B)		
15	1/2	21.7	2.8
20	3/4	27.2	2.8
25	1	34.0	3.2
32	1 1/4	42.7	3.5
40	1 1/2	48.6	3.5
50	2	60.5	3.8
65	2 1/2	76.3	4.2
80	3	89.1	4.2
90	3 1/2	101.6	4.2
100	4	114.3	4.5
125	5	139.8	4.5
150	6	165.2	5.0
175	7	190.7	5.3
200	8	216.3	5.8
225	9	241.8	6.2
250	10	267.4	6.6
300	12	318.5	6.9
350	14	355.6	7.9
400	16	406.4	7.9
450	18	457.2	7.9
500	20	508.0	7.9

⑪ Dimensions of centrifugal mold cast iron pipe (JIS 5523-1977)

Nominal diameter (mm)	Thickness of pipe T		Actual outer diameter D ₁
	High pressure pipe	Nominal pressure pipe	
75	9.0	7.5	93.0
100	9.0	7.5	118.0
125	9.0	7.8	143.0
150	9.5	8.0	169.0
200	10.0	8.8	220.0
250	10.8	9.5	271.6
300	11.4	10.0	322.8

⑫ Cast iron pipe for waste water (JIS G5525-1975)

Nominal diameter	Thickness of pipe	Actual inner diameter	Actual outer diameter
	T	D ₁	D ₂
50	6.0	50	62
65	6.0	65	77
75	6.0	74	87
100	6.0	100	112
125	6.0	125	137
150	6.0	150	162
200	7.0	200	214

⑬ Steel pipe coated for city water STW (JIS G3443-1987)

Nominal diameter A	Outer diameter mm	kinds of symbol				Kinds of symbol			
		STW 30	STW 38	STW 41		STW 290	STW 370	STW 400	
				Nominal thickness				Nominal thickness	
				A	B			A	B
Thickness mm	Thickness mm	Thickness mm	Thickness mm	Thickness mm	Thickness mm	Thickness mm	Thickness mm		
80	89.1	4.2	4.5	—	—	4.2	4.5	—	—
100	114.3	4.5	4.9	—	—	4.5	4.9	—	—
125	139.8	4.5	5.1	—	—	4.5	5.1	—	—
150	165.2	5.0	5.5	—	—	5.0	5.5	—	—
200	216.3	5.8	6.4	—	—	5.8	6.4	—	—
250	267.4	6.6	6.4	—	—	6.6	6.4	—	—
300	318.5	6.9	6.4	—	—	6.9	6.4	—	—
350	355.6	—	—	6.0	—	—	—	6.0	—
400	406.4	—	—	6.0	—	—	—	6.0	—
450	457.2	—	—	6.0	—	—	—	6.0	—
500	508.0	—	—	6.0	—	—	—	6.0	—
600	609.6	—	—	6.0	—	—	—	6.0	—
700	711.2	—	—	7.0	6.0	—	—	7.0	6.0
800	812.8	—	—	8.0	7.0	—	—	8.0	7.0
900	914.4	—	—	8.0	7.0	—	—	8.0	7.0
1000	1016.0	—	—	9.0	8.0	—	—	9.0	8.0
1100	1117.6	—	—	10.0	8.0	—	—	10.0	8.0
1200	1219.2	—	—	11.0	9.0	—	—	11.0	9.0
1350	1371.6	—	—	12.0	10.0	—	—	12.0	10.0
1500	1524.0	—	—	14.0	11.0	—	—	14.0	11.0
1600	1625.6	—	—	15.0	12.0	—	—	15.0	12.0
1650	1676.4	—	—	15.0	12.0	—	—	15.0	12.0
1800	1828.8	—	—	16.0	13.0	—	—	16.0	13.0
1900	1930.4	—	—	17.0	14.0	—	—	17.0	14.0
2000	2032.0	—	—	18.0	15.0	—	—	18.0	15.0
2100	2133.6	—	—	19.0	16.0	—	—	19.0	16.0
2200	2235.2	—	—	20.0	16.0	—	—	20.0	16.0
2300	2336.8	—	—	21.0	17.0	—	—	21.0	17.0
2400	2438.4	—	—	22.0	18.0	—	—	22.0	18.0
2500	2540.0	—	—	23.0	18.0	—	—	23.0	18.0
2600	2641.6	—	—	24.0	19.0	—	—	24.0	19.0
2700	2743.2	—	—	25.0	20.0	—	—	25.0	20.0
2800	2844.8	—	—	26.0	21.0	—	—	26.0	21.0
2900	2946.4	—	—	27.0	21.0	—	—	27.0	21.0
3000	3048.0	—	—	29.0	22.0	—	—	29.0	22.0

⑭ Ductile cast iron pipe (JIS G5526-1998)

Nominal diameter	Thickness of pipe	Actual outer diameter
D	T	D ₁
	1st type pipe	
75	7.5	93.0
100	7.5	118.0
150	7.5	169.0
200	7.5	220.0
250	7.5	271.6
300	7.5	332.8
350	7.5	374.0
400	8.5	425.6
450	9.0	476.8
500	9.5	528.0

Nominal diameter	Thickness of pipe	Actual outer diameter
D	T	D ₁
	1st type pipe	
600	11.0	630.8
700	12.0	733.0
800	13.5	836.0
900	15.0	939.0
1000	16.5	1041.0
1100	18.0	1144.0
1200	19.5	1246.0
1350	21.5	1400.0
1500	23.5	1554.0

**⑮ Ductile iron specials
(JIS G5527-1998)**

Nominal diameter (mm)	Thickness of pipe (mm)
75	8.5
100	8.5
150	9.0
200	11.0
250	12.0
300	12.5
350	13.0
400	14.0
450	14.5
500	15.0
600	16.0
700	17.0
800	18.0
900	19.0
1000	20.0
1100	21.0
1200	22.0
1350	24.0
1500	26.0
1600	27.5
1650	28.0
1800	30.0
2000	32.0
2100	33.0
2200	34.0
2400	36.0

⑯ Arc welded big diameter stainless steel pipe for pipe arrangement (JIS G3468-1994)

Nominal diameter		Outer diameter (mm)	Nominal thickness			
			Schedule 5S	Schedule 10S	Schedule 20S	Schedule 40S
A	B		Thickness mm	Thickness mm	Thickness mm	Thickness mm
150	6	165.2	2.8	3.4	5.0	7.1
200	8	216.3	2.8	4.0	6.5	8.2
250	10	267.4	3.4	4.0	6.5	9.3
300	12	318.5	4.0	4.5	6.5	10.3
350	14	355.6	4.0	5.0	8.0	11.1
400	16	406.4	4.5	5.0	8.0	12.7
450	18	457.2	4.5	5.0	8.0	14.3
500	20	508.0	5.0	5.5	9.5	15.1
550	22	558.8	5.0	5.5	9.5	15.1
600	24	609.6	5.5	6.5	9.5	17.5
650	26	660.4	5.5	8.0	12.7	17.5
700	28	711.2	5.5	8.0	12.7	17.5
750	30	762.0	6.5	8.0	12.7	17.5
800	32	812.8	—	8.0	12.7	17.5
850	34	863.6	—	8.0	12.7	17.5
900	36	914.1	—	8.0	12.7	19.1
1000	40	1016.0	—	9.5	14.3	26.2

**⑰ Hard vinyl chloride pipe for city water
(JIS K6742-1999)**

Nominal diameter	Outer diameter	Thickness
13	18	2.5
20	26	3.0
25	32	3.5
30	38	3.5
40	48	4.0
50	60	4.5
75	89	5.9
100	114	7.1
150	165	9.6

⑱ Arc welded carbon steel pipe (JIS G3457-1988)

(Unit mass: kg/m)

Nominal diameter		Thickness (mm)	Thickness (mm)													
(A)	(B)		Outer diameter (mm)	6.0	6.4	7.1	7.9	8.7	9.5	10.3	11.1	11.9	12.7	13.1	15.1	15.9
350	14	355.6	51.7	55.1	61.0	67.7										
400	16	406.4	59.2	63.1	66.9	77.6										
450	18	457.2	66.8	71.1	78.8	87.5										
500	20	508.0	74.3	79.2	87.7	97.4	107	117								
550	22	558.8	81.8	87.2	96.6	107	118	129	139	150	160	171				
600	24	609.6	89.0	95.2	105	117	127	141	152	164	175	187				
650	26	660.4	96.8	103	114	127	140	152	165	178	190	203				
700	28	711.2	104	111	123	137	151	164	178	192	205	219				
750	30	762.0		119	132	147	162	176	191	206	220	235				
800	32	812.8		127	141	157	173	188	204	219	235	251	258	297	312	
850	34	863.6				167	183	200	219	233	250	266	275	315	332	
900	36	914.4				177	194	212	230	247	265	282	291	335	352	
1000	40	1016.0				196	216	236	255	275	295	314	324	373	392	
1100	44	1117.6						260	281	303	324	346	357	411	432	
1200	48	1219.2						283	307	331	354	378	390	448	472	
1350	54	1371.6									399	426	439	505	532	
1500	60	1524.0									444	473	488	562	591	
1600	64	1625.6											521	600	631	
1800	72	1828.8											587	675	711	
2000	80	2032.0												751	791	

19 Velocity of sound subject to change temperature in water (0 to 100°C)

T _i C	Vm/s	T _i C	Vm/s	T _i C	Vm/s	T _i C	Vm/s
0	1402.74						
1	1407.71	26	1499.64	51	1543.93	76	1555.40
2	1412.57	27	1502.20	52	1544.95	77	1555.31
3	1417.32	28	1504.68	53	1545.92	78	1555.18
4	1421.98	29	1507.10	54	1546.83	79	1555.02
5	1426.50	30	1509.44	55	1547.70	80	1554.81
6	1430.92	31	1511.71	56	1548.51	81	1554.57
7	1435.24	32	1513.91	57	1549.28	82	1554.30
8	1439.46	33	1516.05	58	1550.00	83	1553.98
9	1443.58	34	1518.12	59	1550.68	84	1553.63
10	1447.59	35	1520.12	60	1551.30	85	1553.25
11	1451.51	36	1522.06	61	1551.88	86	1552.82
12	1455.34	37	1523.93	62	1552.42	87	1552.37
13	1459.07	38	1525.74	63	1552.91	88	1551.88
14	1462.70	39	1527.49	64	1553.35	89	1551.35
15	1466.25	40	1529.18	65	1553.76	90	1550.79
16	1469.70	41	1530.80	66	1554.11	91	1550.20
17	1473.07	42	1532.37	67	1554.43	92	1549.58
18	1476.35	43	1533.88	68	1554.70	93	1548.92
19	1479.55	44	1535.33	69	1554.93	94	1548.23
20	1482.66	45	1536.72	70	1555.12	95	1547.50
21	1485.69	46	1538.06	71	1555.27	96	1546.75
22	1488.63	47	1539.34	72	1555.37	97	1545.96
23	1491.50	48	1540.57	73	1555.44	98	1545.14
24	1494.29	49	1541.74	74	1555.47	99	1544.29
25	1497.00	50	1542.87	75	1555.45	100	1543.41

Note) T: temperature, V: velocity of sound

20 Velocity of sound and density of various liquids

Name of liquid	T _i C	ρg/cm ³	Vm/s
Acetone	20	0.7905	1190
Aniline	20	1.0216	1659
Alcohol	20	0.7893	1168
Ether	20	0.7135	1006
Ethylene glycol	20	1.1131	1666
n-octane	20	0.7021	1192
o-xylene	20	0.871	1360
Chloroform	20	1.4870	1001
Chlorobenzene	20	1.1042	1289
Glycerin	20	1.2613	1923
Acetic acid	20	1.0495	1159
Methyl acetate	20	0.928	1181
Ethyl acetate	20	0.900	1164
Cyclohexane	20	0.779	1284
Dithionic acid	20	1.033	1389
Heavy water	20	1.1053	1388
Carbon tetrachloride	20	1.5942	938
Mercury	20	13.5955	1451
Nitrobenzene	20	1.207	1473
Carbon disulfide	20	1.2634	1158
Chloroform	20	2.8904	931
n-propyl alcohol	20	0.8045	1225
n-pentane	20	0.6260	1032
n-hexane	20	0.654	1083
Light oil	25	0.81	1324
Transformer oil	32.5	0.859	1425
Spindle oil	32	0.905	1342
Petroleum	34	0.825	1295
Gasoline	34	0.803	1250
Water	13.5	1.	1460
Sea water (salinity: 3.5%)	16	1.	1510

Note) T: temperature, ρ: density, V: velocity of sound

21 Velocity of sound per piping material

Material	Vm/s
Iron	3230
Steel	3206
Ductile cast iron	3000
Cast iron	2460
Stainless steel	3206
Copper	2260
Lead	2170
Aluminum	3080
Brass	2050
Vinylchloride	2640
Acrylics	2644
FRP	2505
Mortar	2500
Tar epoxy	2505
Polyethylene	1900
Teflon	1240

Note) V: velocity of sound

22 Dynamic viscosity coefficient of various liquids

Name of liquid	T _i C	ρg/cm ³	Vm/s	v (×10 ⁻⁶ m ² /s)
Acetone	20	0.7905	1190	0.407
Aniline	20	1.0216	1659	1.762
Ether	20	0.7135	1006	0.336
Ethylene glycol	20	1.1131	1666	21.112
Chloroform	20	1.4870	1001	0.383
Glycerin	20	1.2613	1923	1188.5
Acetic acid	20	1.0495	1159	1.162
Methyl acetate	20	0.928	1181	0.411
Ethyl acetate	20	0.900	1164	0.499
Heavy water	20	1.1053	1388	1.129
Carbon tetrachloride	20	1.5942	938	0.608
Mercury	20	13.5955	1451	0.114
Nitrobenzene	20	1.207	1473	1.665
Carbon disulfide	20	1.2634	1158	0.290
n-pentane	20	0.6260	1032	0.366
n-hexane	20	0.654	1083	0.489
Spindle oil	32	0.905	1324	15.7
Gasoline	34	0.803	1250	0.4 to 0.5
Water	13.5	1.	1460	1.004 (20 _i C)

Note) T: temperature, ρ: density, V: velocity of sound
v: kinematic viscosity

15.2 Command tree

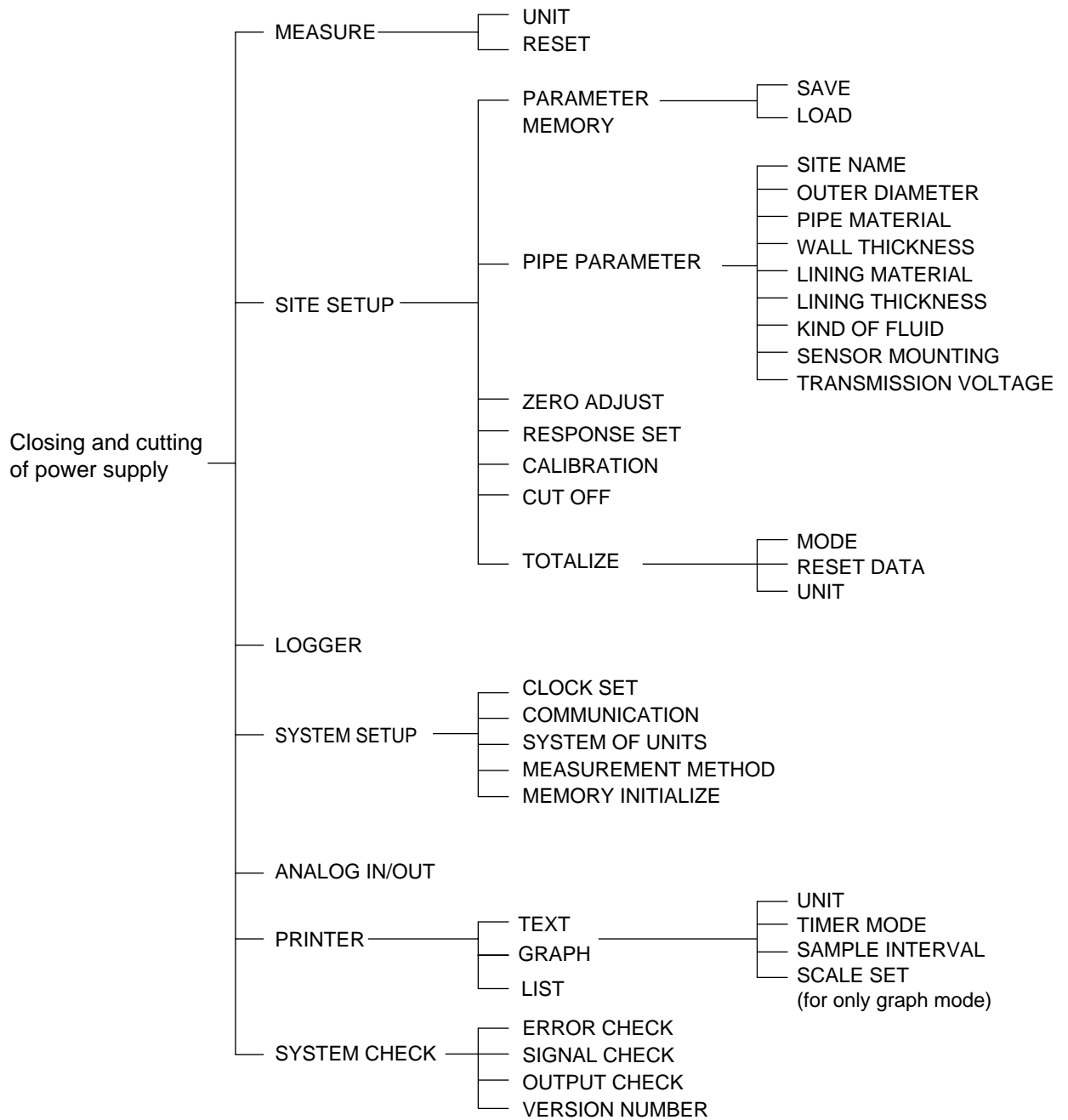

15.3 Specifications

Fluid conditions

- Measured fluid: Homogeneous liquids (water, sea water, oil or fluid of unknown sound velocity) capable of ultrasonic wave propagation
- Turbidity of fluid: 10000 deg. (mg/L) or less
- State of flow: Axis-symmetric flow in pipe filled with fluid
- Fluid temperature: Small diameter sensor, -40 to $+100^{\circ}\text{C}$
Small sensor, [Standard] -40 to $+100^{\circ}\text{C}$
Large sensor, -40 to $+80^{\circ}\text{C}$
High-temperature sensor, -40 to $+200^{\circ}\text{C}$
- Velocity range: -32 to 0 to $+32\text{m/s}$

Piping conditions

- Pipe material: Steel, stainless steel, cast iron, vinyl-chloride, FRP, asbestos, aluminum, acrylic, etc.
- Pipe size: Small diameter sensor, $\phi 13$ to $\phi 100$
Small sensor, $\phi 50$ to $\phi 400$
Large sensor, $\phi 200$ to $\phi 6000$
High-temperature sensor, $\phi 50$ to $\phi 400$
- Lining material: None, tar epoxy, mortar, rubber or material of known sound velocity
- Straight pipe length: Upstream side, 10D or more
Downstream side, 5D or more (D: inner pipe diameter)
Refer to Japan Electric Measuring Instruments Manufacturers' Association's standard JEMIS-032 for details.

Accuracy

Pipe size	Flow velocity	Accuracy
$\phi 13$ to $\phi 50$ or less	2 to 32 m/s	1.5% of rate
	0 to 2 m/s	0.03m/s
$\phi 50$ to $\phi 300$ or less	2 to 32 m/s	1.0% of rate
	0 to 2 m/s	0.02m/s
$\phi 300$ to $\phi 6000$	1 to 32 m/s	1.0% of rate
	0 to 1 m/s	0.01m/s

(Note) Reference conditions are based on JEMIS-032.

Converter

- Power supply: Built-in battery or power adaptor
- Built-in battery: Special type Ni-MH battery
Continuous operation time, about 5 hours (without printer, back light OFF, without current output, transmission voltage setting $\times 1$)
Recharging time, about 2 hours (power adaptor used)
- Power adaptor: Special type power adaptor 90 to 264V AC, 47 to 63Hz or 10 to 30V DC
- Power consumption: 12W or less
- LCD display: Full dot graphic display
240 x 320 dot (with back light)
- LED display: DC IN (green), FAST CHARGE (red)
- Key pad: 10 keys (ON, OFF, \triangle , ∇ , \triangleright , \triangleleft , ESC, ENT, LIGHT, PRINT)
- Power failure backup: Memory backup with lithium battery (effective term, 5 years)
- Response time: 1s or less
- Output signal: 4 to 20mA DC, 1 point (load resistance, 0 to 1k Ω)
- Input signal: 4 to 20mA DC (not isolated), 1 point
- Serial communication: RS-232C (not isolated), 1 point
Transmission speed: Max. 9600 bps
Transmission distance: Max. 15m
- Printer (option): To be mounted on top of converter
Thermal serial dot printing (8 x 256 dot)
- Ambient temperature: -10 to $+55^{\circ}\text{C}$ (without printer)
 -10 to $+45^{\circ}\text{C}$ (with printer)
- Ambient humidity: 90% RH or less
- Type of enclosure: Dust-proof type (IP50 or equivalent)

- Enclosure case: Plastic case (color: gray)
- Dimensions: H240 x W127 x D70mm (without printer)
H359 x W127 x D70mm (with printer)
- Mass: 1.5kg (without printer)
2.0kg (with printer)

Detector (Type: FLD)

- Mounting method: Mounting on outside of already constructed pipe
- Sensor mounting method: V or Z method
- Mounting belt /wire: Small diameter sensor, plastic cloth belt
Small sensor, plastic cloth belt
Large sensor, stainless wire
High-temperature sensor, stainless belt
- Acoustic coupler: Silicone grease
- Signal cable: Special type coaxial cable
- Connection: Converter; BNC connector
Small diameter sensor; BNC connector
Small sensor; BNC connector
Large sensor; terminal screws
High-temperature sensor; BNC connector
- Ambient temperature: -20 to +60°C
- Ambient humidity: Large sensor, 100% RH or less
Other, 90% RH or less
- Type of enclosure: Large sensor: immersion-proof type (IP67 or equivalent)
Other: drip-proof type (IP52 or equivalent)

Material:	Kind	Sensor case	Mounting bracket
	Small diameter	Plastic	Aluminum alloy + Plastic
	Small type	Plastic	Aluminum alloy + Plastic
	Large type	Plastic	—
	High temperature	304SS	Aluminum alloy + 304SS

Dimensions/mass:	Kind	Dimensions (HxWxD)	Mass
	Small diameter	420 x 53 x 90mm	0.6kg
	Small type	540 x 53 x 90mm	0.8kg
	Large type	104 x 93 x 62mm	1.4kg (Note)
	High temperature	530 x 52 x 205mm	1.7kg

Note) mass of both sensors

Functions

- Display language: English/Japanese (Katakana)/German/French, selectable
- Instantaneous value display function: Two of velocity, flow rate (with flow direction) and analog input, simultaneous display
Unit: Velocity m/s
Flow rate L/s, L/min, L/h, ML/d, m³/s, m³/min, m³/h, Mm³/d
- Total value display function: Forward and reverse total values, simultaneous display
Unit: mL, L, m³, km³, Mm³
- Clock display function: Time (year, month, day, hour, minute) display and setting
- Damping: 0 to 99s (time constant)
- Low flow cut: 0 to 1.000m/s
- Output setting function: Current output scaling, output type, burnout setting and calibration
- Communication function: Velocity, flow rate, totals, analog input, status, logging data transmission on request
- Memory function: Site data (place, piping, fluid, sensor mounting method, type of sensor) up to 20 places and a maximum of 40000 data (time, velocity, flow rate, totals, analog input, status) can be stored in memory.
- Waveform display function: Display of bi-directional received waveforms
- Graph display function: Display of velocity, flow rate trend graph
- Printing function: Printout of screen, fixed cycle printout (time, velocity, flow rate, totals, analog input, status), logging data, trend graph, and waveforms by using integral printer (option)

15.4 Q & A

I. Q & A about pipes

1. How is piping setting made when piping specifications are unknown ?

Flow rate can be measured within the range of the specifications by entering the standard value, but the accuracy cannot be guaranteed.

- * Outer diameter can be confirmed by measuring the outside circumference.
- * Thickness can be confirmed by using a piping thickness gauge.

2. What is the effect of coating outside the piping ?

In general, when the outside wall of the piping is rusted and contaminated with deposits of foreign objects, coating materials, etc., so the sensor is not fitted firmly to the piping, measurement cannot be made if there is an air gap which prevents the passage of ultrasonic waves.

In this case, the sensor should be mounted after removing the contamination.

Measurement at a point with uniform coating can be made without problems.

There are no problems with a thick coating (more than several mm), but the measurement accuracy can be improved by adding the lining thickness to the coating thickness and entering it prior to measurement.

When wrapped with jute, the jute should be removed before measurement.

3. What is the effect of scales in the piping ?

Measurement can be made even when there are scales in the piping, but the amount of reduction of the sectional area due to scaling will become an error.

Therefore, the flow indicated is a little larger than the actual flow.

When the scale thickness is known, it can be compensated by adding it to the lining thickness and entering it for measurement. In general, the state of deposit of scales in old piping is not uniform, and shows an uneven surface. Therefore, an accurate cross-sectional area of flow passage cannot be measured.

Also, the flow profile is not uniform, and an accurate measurement of flow cannot be expected, strictly speaking.

II. Q & A about fluids

1. What is homogenous fluid through which ultrasonic waves are transmitted ?

Municipal water can be measured over the range from raw water to clean water without problems.

Sewage flows can be measured up to return sludge.

If the flow contains many air bubbles, it cannot be measured. In general, the less foreign objects (including air bubbles) the flow contains, the more easily can it be measured.

2. Is it possible to measure the flow in piping that is not full?

In horizontal piping, if the pipe is filled with liquid up to $2/3$ of inside diameter D as shown below, the flow velocity can be measured. In this case, the flow rate indicated is the assumed one under filled pipe conditions.

Therefore, the flow indicated is larger than the actual flow.

If sludge is accumulated on the bottom of the piping, the flow velocity can be measured up to $1/3$ of inside diameter D . In this case, the flow rate indicated is the assumed one under filled pipe conditions without any sludge.

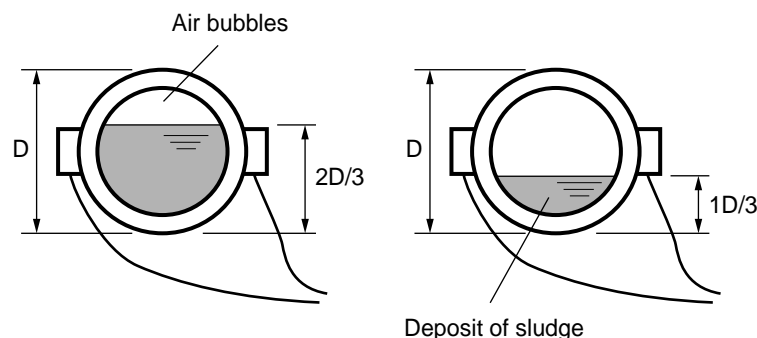

3. What happens when the liquid contains air bubbles ?

The PUX unit is highly resistant to entry of air bubbles in pipes with the aid of the advanced ABM system as shown below.

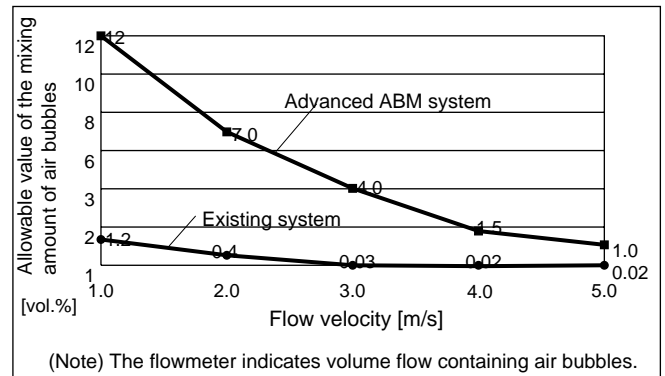

* Example of measured data

When liquid contains excessive air bubbles, no measurement can be made because of transmission failure of the ultrasonic waves. When air bubbles enter the liquid momentarily, the output is retained by the self-check function, thereby causing no problems. Air bubbles easily enter liquid in the following cases.

- (1) Suction of air due to low liquid level of pump well
- (2) Occurrence of cavitation
- (3) Pressure in the piping becomes negative and air enters from piping connection.

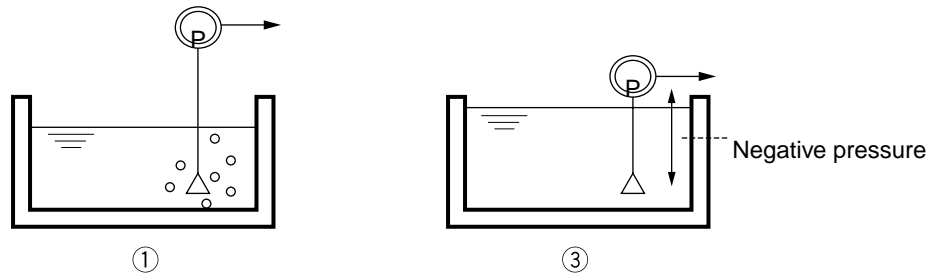

III Q & A about measuring conditions at locations

1. What about mounting the sensor on horizontal piping ?

The sensor should be mounted in the horizontal direction on the piping circumference to prevent the effects of accumulated sludge (lower) and air bubbles (upper).

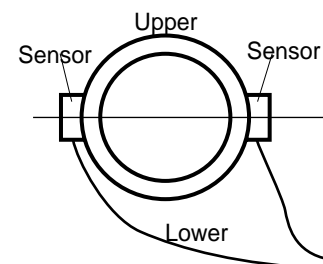

2. What about mounting the sensor on vertical piping ?

The sensor can be mounted on any external position of vertical piping. The recommendable flow direction is upward to avoid the interference of bubbles.

3. When the length of straight piping is short and a pump, valve, orifice, etc. is present, what is required for measurement ?

In general, the length of straight piping on upstream side should be longer than 10D, and that on downstream side should be longer than 5D. When a pump, valve, orifice, etc. is present, measurement should be made at a location greater than 30D away on the upstream side and greater than 5D away on the downstream side.

4. How far can the sensor extension cord be extended ?

Extension cords can be connected and extended up to 100m.
(Special cable with BNC connector: 10m × 2 or 50m × 2 available optionally)

IV. Q & A about accuracy

1. What is the approximate accuracy of measurement ?

Specifications:

Inside diameter	Flow velocity	Accuracy
φ13 to φ50 or less	2 to 32m/s	- 1.5% of measured flow
	0 to 2m/s	- 0.03m/s* ¹
φ50 to φ300 or less	2 to 32m/s	- 1.0% of measured flow
	0 to 2m/s	- 0.02m/s
φ300 to φ6000	1 to 32m/s	- 1.0% of measured flow
	0 to 1m/s	- 0.01m/s

*1: Example of calculation

Error at 2m/s? → $-0.03 \times 100/2 = -1.5\%$

Error at 1m/s? → $-0.03 \times 100/1 = -3.0\%$

Formerly, the expression ■ % of full scale was often used. But, in the recent age of digital systems, it is more frequently expressed in % of the displayed value. Under the condition of low flow velocity, the absolute value of error is used as a standard of accuracy in consideration of the threshold of device performance.

2. What about error factors ?

On the PUX, ultrasonic waves are emitted from the outside of the piping and the time is measured while the waves are passing through the piping material - fluid - piping material. The following points become the error factors to be considered when evaluating the measured values.

(1) Piping size

When the value set for piping size is different from the actual size of piping, and if the difference from the inside diameter is about 1% in size, the error is about 3% of deviation obtained by flow conversion.

(The following shows an example of 1mm deviation in inside diameter)

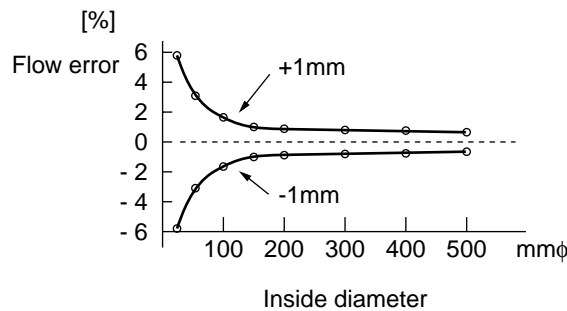

(2) Difference in sensor mounting length

As a general standard, when the error in mounting length is ±1mm, the error of flow is within 1%.

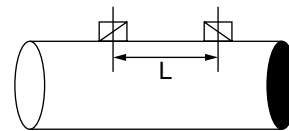
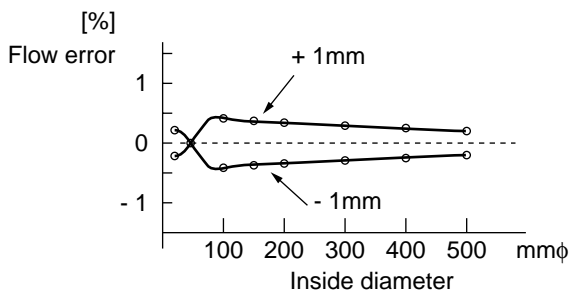

(3) Flow in piping is deviated

When the straight piping is short (particularly upstream side), the flow has become skewed and some deviation error will occur, or fluctuation of indicated value will occur when the flow is swirling.

(4) Inside diameter different from set value due to deposits of scales inside the piping

The error is the same as noted in (1). If scales are badly deposited, receiving waves are not available and measurement may be disabled.

(5) Change in water temperature

Sound velocity of the water is calculated in real time and change in fluid temperature is compensated (new sound velocity measuring system), but there is a slight error.

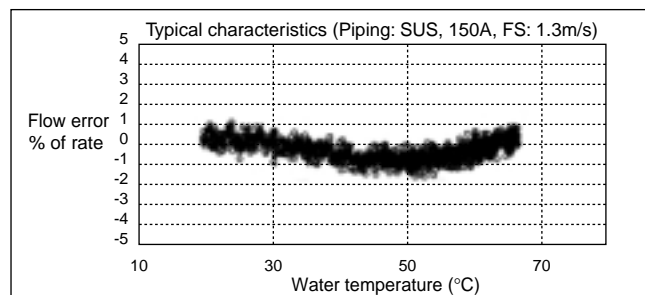

* Example of measurement

(6) Weak received wave due to improper mounting condition and piping condition

Measurement may be possible. But, if received wave is weak, it may result in a large error due to the effect of external noise.

(7) Output when the liquid contains air bubbles

When the amount of air bubbles contained in the liquid is lower than the allowable value indicated before, the measurement indicates volume flow containing air bubbles.

3. What about comparison with other flowmeters ?

Although thermometers and pressure gauges can easily be calibrated at a site, flowmeters are generally very difficult to calibrate at a site.

Therefore, the meter is often used for checking other flowmeters. After checking, the result of comparison of flowmeters should be evaluated with care while considering to the following points.

(1) Consideration of error of each flowmeter

Evaluate the calibration error in consideration for accuracy indication (percentage in FS or percentage of the rate)

(2) Study data systematically, if an error is found.

Do not compare values only at 1 point of flow. Draw many samples on a graph and arrange them systematically for clear evaluation.

(3) Thoroughly check the piping system.

If fluid flows into or out of a branch pipe in the middle of a piping system, the comparison data of each side of such a pipe-junction may not match each other.

When there is storage in the middle of piping system and it becomes a buffer for the flow, the liquid level of the storage area should be taken into consideration.

(4) Comparison of 2 different sets of flowmeters is difficult.

When there is a difference between 2 sets of flowmeters, it is difficult to judge the correct one. So, another judgement criteria needs to be considered.

V. Others

1. What is the difference between a Doppler type flowmeter and the PUX meter?

A Doppler type flowmeter emits ultrasonic waves and receives the waves reflected from foreign objects in the fluid.

Velocity is measured utilizing the principle that the frequency deviation of the received waves from the emitted ones is in proportion to the flow velocity (Doppler effect).

Therefore:

- (1) The fluid must contain foreign objects (including air bubbles). It is not suited for clean water but is suited for sewage.
- (2) Since the position in the fluid where the reflection occurs is obscure, the amount and nature of foreign objects in the fluid affect the measuring accuracy together with the velocity profile in the piping.

The PUX unit is designed to measure the velocity with ultrasonic waves passing through piping. As it measures an average velocity in the piping, it measures flow rate highly accurately.

The Doppler system has the above-mentioned disadvantage, but it is used to measure an approximate flow from the outside of the piping, permits liquids with large amount of foreign objects, and is effectively used for liquids with slurry or air bubbles.

2. Life span of LCD

The life span of LCD is considered to be about 10 years under general operating conditions, according to the manufacturer's catalogue. Generally, it is about 5 to 6 years in actual service.

The life span is not so much related to the number of displaying operations.

3. Printer roll sheet

- (1) Supplied printer roll sheet is 20 meters long.

The roll sheet is fed at 0.35 mm/dot.

Setting the paper feed at a cycle of 1 second uses a roll of paper in 57,140 sec. (about 15.87 hours) = 20 m / 0.35 mm.

- (2) In case of TEXT mode

A single printing consists of the following:

- ① Date (1 line),
- ② Flow velocity, flow rate, and total (several lines),
- ③ Measuring conditions (1 line)
- ④ Paper-feed (1 line)

A printer has a paper fed at 2.8 mm/line.

For example, if you select flow rate (m³/h), flow velocity and +total, the paper feed totals 6 lines (16.8 mm). If a printing cycle is assumed to set to 1 minute, a roll of paper will be used for 1190 minutes (about 19.8 hours) = 20 meters/16.8 mm

Dwyer Instruments, Inc.

Corporate Headquarters
102 Indiana Highway 212
P.O. Box 373
Michigan City, IN 46361 U.S.A.

Telephone: 219/879-8000
Fax: 219/879-9057

www.dwyer-inst.com

BULLETIN F-68
TN2PUXd-E
