

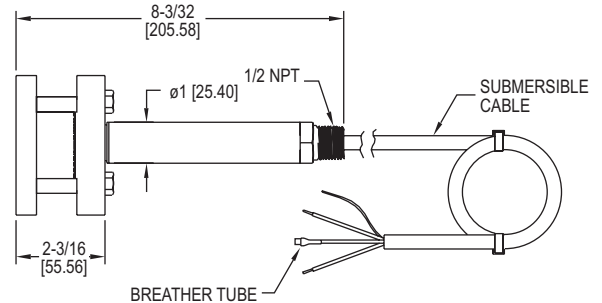

Series PBLTX Submersible Level Transducer

Specifications - Installation and Operating Instructions

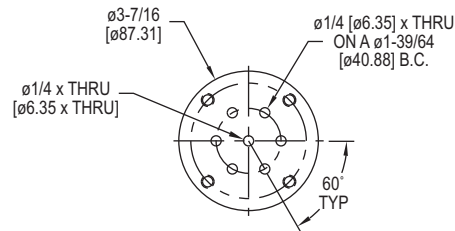

The **Series PBLTX Submersible Level Transducer** is manufactured for years of trouble free service in the harshest applications. The PBLTX measures the height of liquid above its position in the tank referenced to atmospheric pressure. The transducer consists of a piezoresistive sensing element, encased in a 316 SS housing. Perfect for wastewater and slurry applications with features to protect the unit from these demanding applications. Large diameter 316 SS diaphragm seal is non-clogging and damage resistant to floating solids.

Comes equipped with a 270-pound tensile strength, shielded, vented cable. Ventilation tube in the cable automatically compensates for changes in atmospheric pressure above the tank. The vent is protected with a maintenance free filter eliminating particulate or water droplets from entering the transducer.

Intrinsic Safety Approval Classification

The PBLTX is UL listed for use in Hazardous (Classified) Locations. The protection method is by Intrinsic Safety, "ia". It was investigated by UL under UL Standard 913 8th Edition, CAN/CSA C22.2 No. 60079-0:15 and CAN/CSA C22.2 No. 60079-11:14.

Hazardous (Classified) Location Intrinsically Safe For:

Class I Div. 1 Groups A,B,C,D
 Class II Div. 1 Groups E,F,G
 Class III Div. 1
 Class I Zone 0 AEx ia IIC T4 Ga
 Zone 20 AEx ia IIIC T135°C Da
 Ex ia IIC T4 Ga
 Ex ia IIIC T135°C Da
 Ta = -20°C to 80°C (ETFE Cable)
 Ta = -20°C to 65°C (Polyurethane Cable)
 Install in accordance with Control Drawing 001833-44.
 See Control Drawing 001833-44 for Entity Parameters.

ATEX: EU Type Certificate NO. DEMKO 18 ATEX 2080

ATEX STANDARDS: EN 60079-0:2012/A11:2013

EN 60079-11:2012

ATEX CLASSIFICATION: **CE** 0518 **Ex** II 1 G Ex ia IIC T4 Ga (-20°C ≤ Tamb ≤ 80°C (ETFE Cable)) (-20°C ≤ Tamb ≤ 65°C (Polyurethane Cable))

CE 0518 **Ex** II 1 D Ex ia IIIC T135°C Da (-20°C ≤ Tamb ≤ 80°C (ETFE Cable)) (-20°C ≤ Tamb ≤ 65°C (Polyurethane Cable))

IECEX Certificate of Conformity: IECEX UL 18.0086

IECEX STANDARDS: IEC 60079-0: 2011 6TH ED.

IEC 60079-11:2011 6TH ED.

IECEX CLASSIFICATION: Ex ia IIC T4 Ga (-20°C ≤ Tamb ≤ 80°C (ETFE Cable))

(-20°C ≤ Tamb ≤ 65°C (Polyurethane Cable))

Ex ia IIIC T135°C Da (-20°C ≤ Tamb ≤ 80°C (ETFE Cable)) (-20°C ≤ Tamb ≤ 65°C

(Polyurethane Cable))

Install in accordance with Control drawing 001833-47

SEE CONTROL DRAWING 001833-47 FOR ENTITY PARAMETERS.

SPECIFICATIONS

Service: Compatible liquids.

Wetted Materials: Body: 316 SS, 316L SS; Cable: Polyether polyurethane or ETFE; Seals: Fluoroelastomer.

Accuracy: ±0.25% FS.

Temperature Limit: ETFE cable equipped -4 to 176°F (-20 to 80°C); Polyurethane cable equipped -4 to 149°F (-20 to 65°C).

Compensated Temperature Range: -4 to 176°F (-20 to 80°C).

Thermal Effect: Less than ±.02%/ FS/°F.

Pressure Limit: 2X FS.

Power Requirement: 10-28 VDC.

Output Signal: 4-20 mA DC, two wire.

Response Time: 50 msec.

Max. Loop Resistance: 900 Ω.

Electrical Connection: Wire pigtail.

Mounting Orientation: Suspended in tank below level being measured. Can be placed on the bottom of the tank on its side.

Weight: 4.3 lb (2.0 kg).

Agency Approvals: CE, See Intrinsic Safety Approval Classification.

WARNING Use with approved safety barriers using entity evaluation.

CAUTION

Do not exceed specified supply voltage ratings. Permanent damage not covered by warranty will result. This device is not designed for 120 or 240 volt AC operation. Use only on 10-28 VDC.

INSTALLATION

1. Location: Select a location where the temperature of the transducer will be between -4 and 176°F (-20 to 80°C) for ETFE cable or -4 and 149°F (-20 to 65°C) for polyurethane cable. Distance from the receiver is limited only by total loop resistance.

2. Position: The transducer is not position sensitive. However all standard models are originally calibrated with the unit in a position with the diaphragm downward. Although they can be used at other angles, for best accuracy it is recommended that units be installed in the position calibrated at the factory.

3. Mounting: The transducer can be mounted via several methods. It can be suspended from the electrical cable, it can be placed resting on the bottom of the tank in either horizontal or vertical orientation, or it can be attached to a pipe or hang wire by the 1/2" NPT male connection on the top of the housing.

4. Wire Length: The maximum length of wire connecting the transducer and receiver is a function of wire size and receiver resistance. Wiring should not contribute more than 10% of the receiver resistance to total loop resistance. For extremely long runs (over 1000 feet), choose receivers with higher resistance to minimize the size and cost of connecting leads. Where wiring length is under 100 feet, wire as small as 22 AWG can be used.

5. Wiring: An external power supply delivering 10-28 VDC with minimum current capability of 40 mA DC (per transducer) is required to power the control loop. See Figure A for connection of the power supply, transducer and receiver. The range of appropriate receiver load resistance (RL) for the DC power supply voltage available is expressed by the formula:

$$RL \text{ Max} = \frac{V_{ps} - 10 \text{ V}}{20 \text{ mA DC}}$$

Shielded cable is recommended for control loop wiring.

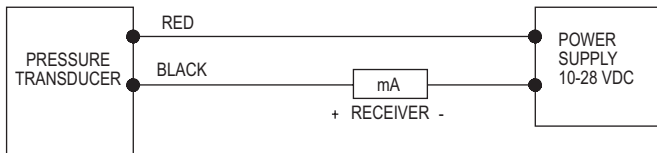

Figure A

Black wire is negative (-) and red wire is positive (+) in Figure B.

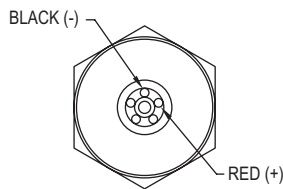

Figure B

MAINTENANCE

After final installation of the pressure transducer and its companion receiver, no routine maintenance is required. A periodic check of system calibration is suggested. The Series PBLTX transducers are not field repairable and should be returned if repair is needed (field repair should not be attempted and may void warranty). Be sure to include a brief description of the problem plus any relevant application notes. Contact customer service to receive a return goods authorization number before shipping.

- NOTES:
 1. SELECTED ASSOCIATED APPARATUS MUST BE THIRD PARTY LISTED AS PROVIDING INTRINSICALLY SAFE CIRCUITS FOR THE APPLICATION, AND NOT EXCEED THE ENTRY PARAMETERS LISTED ON THIS DRAWING.
 2. CAPACITANCE AND INDUCTANCE OF THE FIELD WIRING FROM THE INTRINSICALLY SAFE TRANSDUCER TO THE ASSOCIATED APPARATUS SHALL BE CALCULATED AND MUST INCLUDE THE SYSTEM CALCULATIONS AS SHOWN WITHIN THIS DRAWING. TOTAL CAPACITANCE IS CALCULATED BY ADDING BOTH (C_{max cable}) AND (C_{max}) TO C, WHERE (C_{max cable}) IS THE CAPACITANCE OF FACTORY WIRING PROVIDED WITH THE PBLTX AND (C_{max}) IS CAPACITANCE OF ANY ADDITIONAL END USER CABLE THAT IS WIRED TO THE PBLTX. TOTAL INDUCTANCE IS CALCULATED BY ADDING BOTH (L_{max cable}) AND (L_{max}) TO L, WHERE (L_{max cable}) IS THE INDUCTANCE OF FACTORY WIRING PROVIDED WITH POLYURETHANE CABLE, THE CAPACITANCE (C_{max cable}) IS 96 PF/FT (315PF/M) AND INDUCTANCE (L_{max cable}) IS 346nH/FT (1.135nF/M). WHEN PROVIDED WITH POLYURETHANE CABLE, THE CAPACITANCE (C_{max cable}) IS 96 PF/FT (315PF/M) AND INDUCTANCE (L_{max cable}) IS 340 nH/FT (1.116nF/M). WHERE CABLE CAPACITANCE AND INDUCTANCE PER UNIT LENGTH ARE NOT KNOWN, THE CAPACITANCE OF 609PF/FT (2009F/M) AND INDUCTANCE OF 0.2uH/FT (1.0 uH/M) MAY BE USED. PLEASE NOTE THAT THE PBLTX CABLE LENGTH IS SPECIFIED WITHIN THE NOMENCLATURE, SEE ITEM "ccc" FOR LENGTH AND ITEM "d" FOR UNIT OF LENGTH. THIS LENGTH WILL NEED TO BE MULTIPLIED BY THE CORRECT PARAMETER (C_{max cable}) AND (L_{max cable}) SPECIFIED ABOVE, BASED ON THE CABLE PROVIDED, SEE NOMENCLATURE ITEM "e" FOR THE DEVICE'S CABLE TYPE.
 3. THE ASSOCIATED APPARATUS MANUFACTURER'S INSTALLATION INSTRUCTIONS MUST BE FOLLOWED WHEN INSTALLING THE EQUIPMENT.
 4. WARNING - ALL FIELD WIRING SHALL BE SUITABLE FOR AN AMBIENT TEMPERATURE RANGE OF -20 TO 80°C.
 5. THE CABLE USED IN THIS DEVICE HAS A VENT TUBE. THEREFORE THE CABLE ATTACHED TO THE PBLTX SHALL BE TERMINATED IN THE HAZARDOUS AREA.
 6. NO REVISIONS TO THIS DRAWING WITHOUT PRIOR APPROVAL BY UL/DEWKO.
 7. TRANSDUCER MUST BE INSTALLED IN ACCORDANCE TO IEC/EN 60079-14 OR ANY LOCAL INSTALLATION CODES/REQUIREMENTS.

ATEX CLASSIFICATION: **II 1 G Ex ia IIC T4 Ga (-20°C ≤ Tamb ≤ 80°C (ETFE CABLE)) (-20°C ≤ Tamb ≤ 65°C (POLYURETHANE CABLE))**
 IECEx CLASSIFICATION: **Ex ia IIC T4 Ga (-20°C ≤ Tamb ≤ 80°C (ETFE CABLE)) (-20°C ≤ Tamb ≤ 65°C (POLYURETHANE CABLE))**
 Ex ia IIC T1.35°C Da (-20°C ≤ Tamb ≤ 80°C (ETFE CABLE)) (-20°C ≤ Tamb ≤ 65°C (POLYURETHANE CABLE))

ATEX STANDARDS: EN 60079-0:2012(A11:2013)
 EN 60079-11:2012

IEC STANDARDS: IEC 60079-0:2011 6TH ED.
 IEC 60079-11:2011 6TH ED.

- PBLTX-3000-0000-CCCF-A1EX-1
 - BLANK (STANDARD) OR 2YR(2 YEAR WARRANTY) WARRANTY TYPE
 - ATEX (ATEX/IECEx COMPLIANT) CONFIGURATION
 - BLANK(ETFE CABLE) OR PU(POLYURETHANE CABLE) CABLE TYPE
 - BLANK(FEET) OR (METERS) CABLE UNITS
 - ONE TO THREE DIGIT NUMERIC CHARACTER
 - 1 TO 470(FEET) OR 1 TO 143(METERS) FOR POLYURETHANE CABLE.
 - 1 TO 275(FEET) OR 1 TO 84(METERS) FOR ETFE CABLE CABLE LENGTH
 - BLANK(P/S) OR (METERS) RANGE UNITS
 - ONE TO FIVE DIGIT NUMERIC CHARACTER,
 - 5 TO 145(P/S)
 - 3.5 TO 100 METERS OF WC SENSOR RANGE

ZONE AND DIVISION ENTRY PARAMETERS ARE SHOWN AS: DIVISION (ZONE)

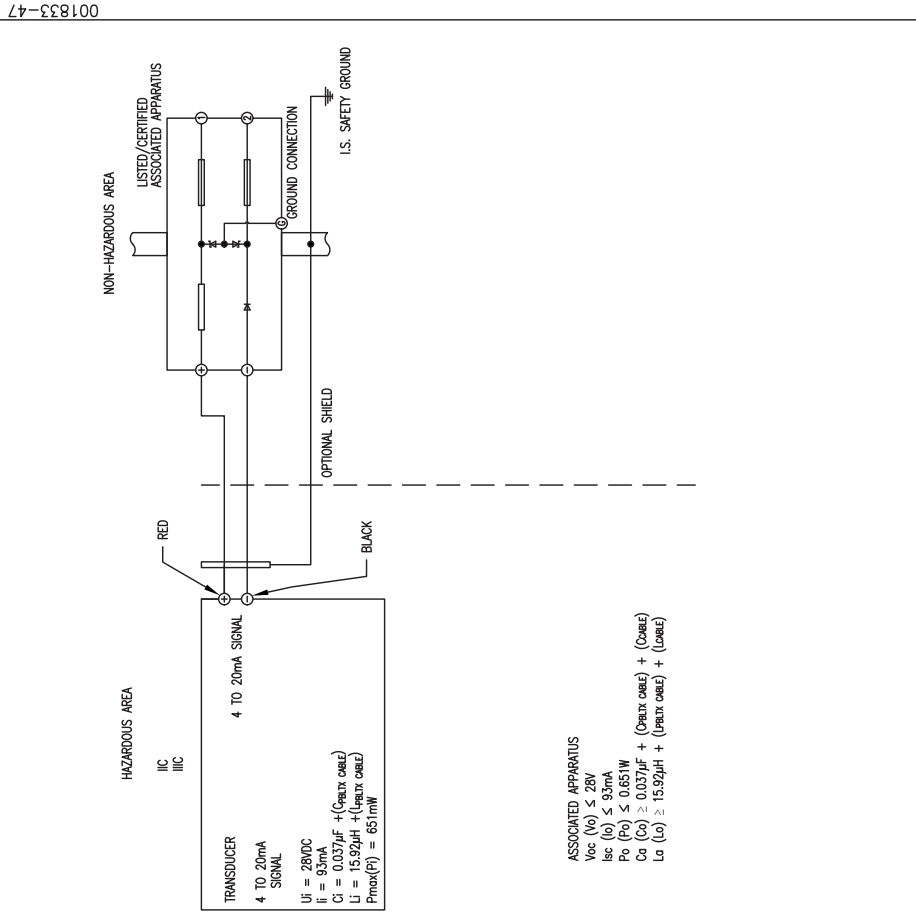

\textcircled{C} = CRITICAL DIMENSION
 DIMENSIONS IN PARENTHESES ARE UNLESS NOTED:
 ALL DECIMAL DIMENSIONS ± .003
 ALL ANGLES ± 1°

- ASSOCIATED APPARATUS
 Voc (V) ≤ 28V
 Isc (I) ≤ 93mA
 Po (P) ≤ 0.651W
 Co (C) ≥ 0.037uF + (C_{max cable}) + (C_{cable})
 Lo (L) ≥ 15.92uH + (L_{max cable}) + (L_{cable})

MATERIAL		NAME	
FINISH		DATE	02-14-18
I.S. CONTROL DRAWING			
ATEX/IECEx			
REV		DATE	BY
2	ADD'D ATEX CONFIGURATION PER ECR #045704	12-10-18	DWN
1	GENERAL REVISION AS REQUESTED BY UL PER ECR #43410	6-20-18	RBS
0	INITIAL RELEASE NO-005145	02-28-18	AMS
NO.		BY/DATE	LR
CHANGES			
ACAD2002			
FR. NO.		001833-47	
Dwyer Instruments, Inc.		MICHIGAN CITY, INDIANA 46360 U.S.A.	

NOTICE: This drawing and the principles and elements of design embodied therein are the exclusive property of DWYER INSTRUMENTS, INC. and are not to be used, copied, or reproduced in any form without the written consent of DWYER INSTRUMENTS, INC. and must not be submitted to outside parties for reproduction without the written consent of DWYER INSTRUMENTS, INC.

Tauchpegelwandler der Serie PBLTX

Technische Daten – Installation und Betriebsanleitung

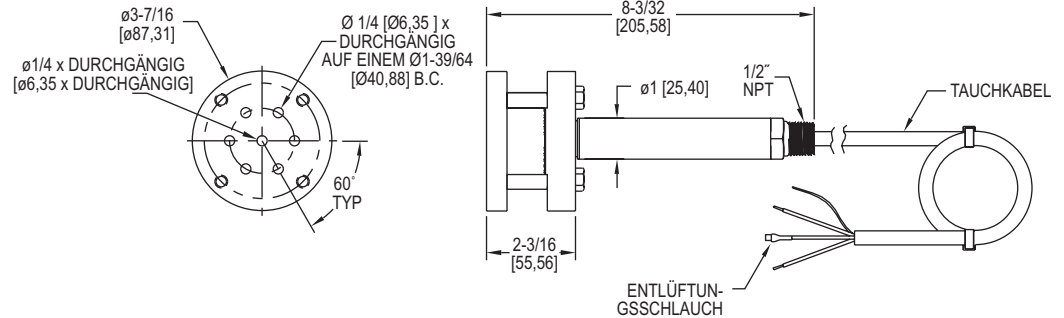

Tauchpegelwandler der Serie PBLTX werden für jahrelange problemlose Wartung in härtesten Anwendungen hergestellt. Der PBLTX misst den Flüssigkeitsstand über seiner Position im Tank mit Bezug auf den atmosphärischen Druck. Der Wandler besteht aus einem piezoresistiven Sensorelement, das in einem Gehäuse aus 316 Edelstahl integriert ist. Perfekt geeignet für Abwasser- und Gülleanwendungen mit Funktionen zum Schutz des Geräts bei diesen anspruchsvollen Anwendungen. Die 316 Edelstahl-Membrandichtung mit großem Durchmesser ist verstopfungsfrei und widerstandsfähig gegen schwimmende Feststoffe.

Wird mit einem abgeschirmtem, entlüfteten Kabel mit einer Zugfestigkeit von 270 lb (122 kg) geliefert. Der Entlüftungsschlauch im Kabel kompensiert automatisch Änderungen des atmosphärischen Drucks oberhalb des Tanks. Die Entlüftungsöffnung ist durch einen wartungsfreien Filter geschützt, der das Eindringen von Partikeln oder Wassertröpfchen in den Wandler verhindert.

Klassifizierung der Zulassung für Eigensicherheit

Der PBLTX ist UL-gelistet für den Einsatz an gefährlichen (klassifizierten) Standorten. Die Schutzmethode erfolgt durch Eigensicherheit, "ia". Er wurde von UL gemäß UL-Norm 913 8. Ausgabe, CAN/CSA C22.2 Nr. 60079-0:15 und CAN/CSA C22.2 Nr. 60079-11:14 untersucht.

Für die folgenden Gefahrenbereiche (klassifiziert) eigensicher:

Klasse I Div. 1 Gruppen A,B,C,D

Klasse II Div. 1 Gruppen E,F,G

Klasse III Div. 1

Klasse I Zone 0 AEx ia IIC T4 Ga

Zone 20 AEx IA IIIC T135 °C Da

Ex ia IIC T4 Ga

Ex ia IIIC T135 °C Da

Ta = -20 °C bis 80 °C (ETFE-Kabel)

Ta = -20 °C bis 65 °C (Polyurethan-Kabel)

Gemäß Kontrollzeichnung 001833-44 installieren.

Siehe Kontrollzeichnung 001833-44 für Entitätssparameter.

ATEX: EU-Typenzulassung NO. DEMKO 18 ATEX 2080

ATEX-NORMEN: EN 60079-0:2012/A11:2013

EN 60079-11:2012

ATEX-KLASSIFIZIERUNG: **CE** 0518 **Ex** II 1 G Ex ia IIC T4 Ga (-20 °C ≤ Tamb

≤ 80 °C [ETFE-Kabel]) (-20 °C ≤ Tamb ≤ 65 °C [Polyurethankabel])

CE 0518 **Ex** II 1 D Ex ia IIIC T135 °C Da (-20 °C ≤ Tamb ≤ 80 °C [ETFE-Kabel])

(-20 °C ≤ Tamb ≤ 65 °C [Polyurethankabel])

IECEx-Konformitätszertifikat: IECEx UL 18.0086

IECEx-NORMEN: IEC 60079-0: 2011 6. AUFLAGE.

IEC 60079-11:2011 6. AUFLAGE.

IECEx-KLASSIFIZIERUNG: Ex ia IIC T4 Ga (-20 °C ≤ bei Tamb bei ≤ 80 °C [ETFE-

Kabel]) (-20 °C ≤ Tamb ≤ 65 °C [Polyurethankabel])

Ex ia IIIC T135 °C Da (-20 °C ≤ Tamb ≤ 80 °C [ETFE-Kabel]) (-20 °C ≤ Tamb ≤ 65 °C

[Polyurethankabel])

Gemäß Kontrollzeichnung 001833-47 installieren

SIEHE KONTROLLZEICHNUNG 001833-47 FÜR ENTITÄTSPARAMETER.

TECHNISCHE DATEN

Wartung: Kompatible Flüssigkeiten.

Benetzte Materialien: Körper: 316 Edelstahl, 316L Edelstahl; Kabel: Polyether-Polyurethan oder ETFE; Dichtungen: Fluorelastomer.

Genauigkeit: ±0,25 % FS.

Temperaturgrenze: ETFE-Kabel ausgestattet für -4 bis 176 °F (-20 bis 80 °C);

Polyurethankabel ausgestattet für -4 bis 149 °F (-20 bis 65 °C).

Kompensierter Temperaturbereich: -4 bis 176 °F (-20 bis 80 °C).

Thermische Wirkung: Weniger als ±0,02 %/FS/ °F.

Druckbereich: 2X FS.

Leistungsbedarf: 10-28 VDC.

Ausgangssignal: 4-20 mA DC, zwei Drähte.

Reaktionszeit: 50 msec.

Max. Messkreiswiderstand: 900 Ω.

Elektrische Anschlüsse: Draht-Pigtail.

Montageausrichtung: Aufgehängt im Tank unterhalb des gemessenen Pegels.

Kann auf der Unterseite des Tanks auf seiner Seite platziert werden.

Gewicht: 4,3 lb (2,0 kg).

Zulassungen: CE, siehe Klassifizierung der Zulassung für Eigensicherheit.



WARNHINWEIS

Verwendung mit zugelassenen Sicherheitsbarrieren durch Entitätssbewertung.

VORSICHT

Die angegebenen Versorgungsspannungswerte dürfen nicht überschritten werden. Dauerhafte Schäden, die nicht durch die Garantie abgedeckt sind, werden die Folge sein. Dieses Gerät ist nicht für den 120- oder 240-Volt-AC-Betrieb ausgelegt. Es darf nur mit 10–28 VDC verwendet werden.

INSTALLATION

1. Lage: Wählen Sie einen Ort, an dem die Temperatur des Wandlers zwischen -4 und 176 °F (-20 bis 80 °C) für ETFE-Kabel oder -4 und 149 °F (-20 bis 65 °C) für Polyurethankabel liegt. Der Abstand vom Empfänger wird nur durch den Gesamt-Messkreiswiderstand begrenzt.

2. Position: Der Wandler ist nicht ortsempfindlich. Alle Standardmodelle werden jedoch ursprünglich mit dem Gerät in einer Position mit der Membran nach unten kalibriert. Obwohl er in anderen Winkeln verwendet werden kann, wird für beste Genauigkeit empfohlen, dass Geräte in der Position installiert werden, die im Werk kalibriert wurde.

3. Montage: Der Messumformer kann mithilfe mehrere Methoden montiert werden. Er kann vom elektrischen Kabel aufgehängt werden, er kann auf der Unterseite des Tanks in horizontaler oder vertikaler Ausrichtung ruhend platziert werden, oder er kann an einem Rohr oder Hängedraht mit einem 1/2" NPT Steckeranschluss an der Oberseite des Gehäuses befestigt werden.

4. Drahtlänge: Die maximale Länge des Kabels, das den Wandler und den Empfänger verbindet, ist eine Funktion aus Kabelgröße und Empfängerwiderstand. Das Kabel sollte nicht mehr als 10 % des Empfängerwiderstands zum Gesamt-Messkreiswiderstand beitragen. Wählen Sie für extrem lange Strecken (über 1000 Fuß) Empfänger mit niedrigem Widerstand, um die Größe und Kosten der Verbindungskabel zu minimieren. Wo die Verdrahtungslänge unter 100 Fuß (30 m) liegt, kann Draht von nur 22 AWG verwendet werden.

5. Verdrahtung: Für die Stromversorgung des Regelkreises ist ein externes Netzteil mit 10–28 VDC mit einer Mindeststromkapazität von 40 mA DC (pro Wandler) erforderlich. Siehe Abbildung A für eine Darstellung der Verbindung von Stromversorgung, Wandler und Empfänger. Der Bereich des geeigneten Empfängerlastwiderstands (RL) für die verfügbare Spannung der Gleichstromversorgung wird durch die folgende Formel ausgedrückt:

$$RL \text{ Max} = \frac{V_{ps} - 10 \text{ V}}{20 \text{ mA DC}}$$

Für die Steuerringleitung sollten abgeschirmte Kabel verwendet werden.



Abbildung A

Schwarzer Draht ist negativ (-) und roter Draht ist positiv (+) in Abbildung B.

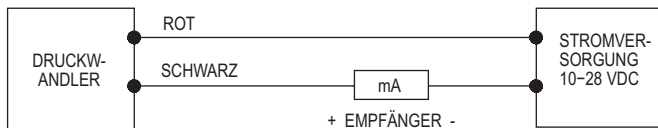

Abbildung B

WARTUNG

Nach der endgültigen Installation des Druckwandlers und seines Begleitempfängers ist keine routinemäßige Wartung erforderlich. Eine regelmäßige Überprüfung der Systemkalibrierung wird empfohlen. Die Wandler der Serie PBLTX sind nicht vor Ort reparierbar und sollten zurückgesandt werden, wenn eine Reparatur erforderlich ist (eine Reparatur vor Ort sollte nicht durchgeführt werden und kann die Garantie ungültig machen). Fügen Sie der Rücksendung eine kurze Erläuterung des Problems sowie relevante Anwendungshinweise bei. Bevor Sie das Produkt einschicken, holen Sie sich bitte beim Kundendienst eine Warenrücksendenummer.

- NOTES:**
1. SELECTED ASSOCIATED APPARATUS MUST BE THIRD PARTY LISTED AS PROVIDING INTRINSICALLY SAFE CIRCUITS FOR THE APPLICATION, AND NOT EXCEED THE ENTITY PARAMETERS LISTED IN THIS DRAWING.
 2. ASSOCIATED APPARATUS OUTPUT CURRENT MUST BE LIMITED BY A RESISTOR SUCH THAT THE OUTPUT VOLTAGE-CURRENT PLOT IS A STRAIGHT LINE DRAWN BETWEEN OPEN-CIRCUIT VOLTAGE AND SHORT-CIRCUIT CURRENT.
 3. CAPACITANCE AND INDUCTANCE OF THE FIELD WIRING FROM THE INTRINSICALLY SAFE TRANSUCER TO THE ASSOCIATED APPARATUS SHALL BE CALCULATED AND MUST INCLUDE THE SYSTEM CALCULATIONS AS SHOWN WITHIN THIS DRAWING. TOTAL CAPACITANCE IS CALCULATED BY ADDING BOTH C_{cable} AND C_{cap} TO C_i , WHERE C_{cable} IS THE CAPACITANCE OF FACTORY WIRING PROVIDED WITH THE PBLTX AND C_{cap} IS CAPACITANCE OF ANY ADDITIONAL END USER CABLE THAT IS WIRED TO THE PBLTX. TOTAL INDUCTANCE IS CALCULATED BY ADDING BOTH L_{cable} AND L_{cap} TO L_i , WHERE L_{cable} IS THE INDUCTANCE OF FACTORY WIRING PROVIDED WITH THE PBLTX AND L_{cap} IS THE INDUCTANCE OF ANY ADDITIONAL END USER CABLE THAT IS WIRED TO THE PBLTX. WHEN PROVIDED WITH POLYURETHANE CABLE, THE CAPACITANCE (C_{cable}) IS 96 pF/FT (315pF/M) AND INDUCTANCE (L_{cable}) IS 346pH/FT (1,135pH/M). WHEN PROVIDED WITH ETFE CABLE, THE CAPACITANCE (C_{cable}) IS 62pF/FT (532 pF/M) AND INDUCTANCE (L_{cable}) IS 340 nH/FT (1,115nH/M). WHERE CABLE CAPACITANCE AND INDUCTANCE PER UNIT LENGTH ARE NOT KNOWN, THE CAPACITANCE OF 60pF/FT (200pF/M) AND INDUCTANCE OF 0.2µH/FT (1.0 µH/M) MAY BE USED. PLEASE NOTE THAT THE PBLTX CABLE LENGTH IS SPECIFIED WITHIN THE NOMENCLATURE, SEE ITEM "C" FOR LENGTH AND ITEM "d" FOR UNIT OF LENGTH. THIS LENGTH WILL NEED TO BE MULTIPLIED BY THE CORRECT PARAMETER (C_{cable} AND L_{cable}) AS SPECIFIED ABOVE, BASED ON THE CABLE PROVIDED. SEE NOMENCLATURE ITEM "e" FOR THE DEVICE'S CABLE TYPE.
 4. TRANSUCERS MUST BE INSTALLED TO THE MANUFACTURER'S CONTROL DRAWING AND ARTICLE S04 OF THE NATIONAL ELECTRICAL CODE (ANSI/NFPA 70) FOR INSTALLATION IN THE UNITED STATES OR SECTION 18 OF THE CANADIAN ELECTRICAL CODE (CSA C22.1) FOR INSTALLATION IN CANADA OR OTHER LOCAL INSTALLATION CODES, AS APPLICABLE.
 5. THE ASSOCIATED APPARATUS MANUFACTURER'S INSTALLATION INSTRUCTIONS MUST BE FOLLOWED WHEN INSTALLING THE EQUIPMENT.
 6. THE CABLE USED IN THIS DEVICE HAS A VENT TUBE. THEREFORE THE CABLE ATTACHED TO THE PBLTX SHALL BE TERMINATED IN THE HAZARDOUS AREA.
 7. NO REVISIONS TO THIS DRAWING WITHOUT PRIOR APPROVAL BY UL.

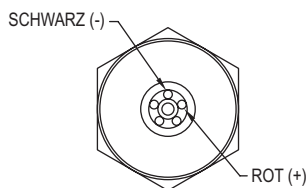
STANDARDS:
 AS REFERENCE BY UL 913 - 8th EDITION CAN/CSA C22.2 NO. 60079-0-15
 UL 60079-0 - 6th EDITION CAN/CSA C22.2 NO. 60079-11:14
 UL 60079-11 - 6th EDITION

- PBLTX - 300.0000-1000 - 44
- L BLANK(STANDARD) OR 2YR(2 YEAR WARRANTY) WARRANTY TYPE
 - L BLANK(ETFE CABLE) OR P(POLYURETHANE CABLE) CABLE TYPE
 - L BLANK(FEET) OR M(METERS) CABLE UNITS
 - L ONE TO THREE DIGIT NUMERIC CHARACTER
 - 1 TO 470(FEET) OR 1 TO 143(METERS) FOR POLYURETHANE CABLE.
 - 1 TO 275(FEET) OR 1 TO 84(METERS) FOR ETFE CABLE CABLE LENGTH
 - L BLANK(Ps) OR M(METERS) RANGE UNITS
 - L ONE TO FIVE DIGIT NUMERIC CHARACTER,
 - 5 TO 145 PSI OR
 - 3.5 TO 100 METERS OF WC SENSOR RANGE

HAZARDOUS (CLASSIFIED) LOCATION INTRINSICALLY SAFE FOR:
 CLASS I, DIV.1 GROUPS A,B,C,D
 CLASS II, DIV.1 GROUPS E,F,G
 CLASS III, DIV.1
 CLASS I ZONE 0 AEx, ia, IIC T4 Gc
 CLASS II ZONE 0 AEx ia IIC T1,35C Dc
 CLASS III ZONE 0 AEx ia IIC T4 Gc
 Ex ia IIC T4 Gc
 Ex ia IIC T1,35C Dc
 Ta = -20 °C TO 65°C(POLYURETHANE CABLE)
 -20°C TO 80°C(ETFE CABLE)

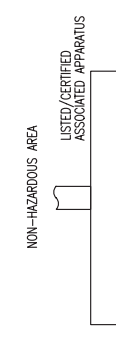
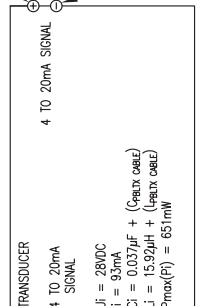

○ = CRITICAL DIMENSION
 ○ = DIMENSION UNLESS NOTED:
 ALL DIMENSIONS ± .005
 ALL ANGLES ± 1°

DATE		NAME	
02-12-18		PBLTX CONTROL DRAWING	
DWN BY		FINISH	
AMS		AMS	
RBS		CHKD	
6-20-18		DGH	
AMS		APPD	
02-28-18		BY/DATE	
LR		LR	
NO.		CHANGES	
NOTICE: This drawing and the physical and electrical elements of design embodied therein are the exclusive property of DWYER INSTRUMENTS, INC. and are not to be communicated, disclosed, reproduced or used in whole or in part without the written consent of DWYER INSTRUMENTS, INC. and are not to be submitted for examination without the written consent of said corporation.			

ZONE AND DIVISION ENTITY PARAMETERS ARE SHOWN AS: DIVISION (ZONE)

FR. NO. 001833-44
 DWYER INSTRUMENTS, INC.
 MICHIGAN CITY, INDIANA 46360 U.S.A.

1. SELECTED ASSOCIATED APPARATUS MUST BE THIRD PARTY LISTED AS PROVIDING INTRINSICALLY SAFE CIRCUITS FOR THE APPLICATION, AND NOT EXCEED THE ENTRY PARAMETERS LISTED ON THIS DRAWING.
2. CAPACITANCE AND INDUCTANCE OF THE FIELD WIRING FROM THE INTRINSICALLY SAFE TRANSDUCE TO THE ASSOCIATED APPARATUS SHALL BE CALCULATED AND MUST INCLUDE THE SYSTEM CALCULATIONS AS SHOWN WITHIN THIS DRAWING. TOTAL CAPACITANCE IS CALCULATED BY ADDING BOTH (C_{ext cable}) AND (C_{cable}) TO C_i, WHERE (C_{ext cable}) IS THE CAPACITANCE OF FACTORY WIRING PROVIDED WITH THE PBLTX AND (C_{cable}) IS CAPACITANCE OF ANY ADDITIONAL END USER CABLE THAT IS WIRED TO THE PBLTX. TOTAL INDUCTANCE IS CALCULATED BY ADDING BOTH (L_{ext cable}) AND (L_{cable}) TO L_i, WHERE (L_{ext cable}) IS THE INDUCTANCE OF FACTORY WIRING PROVIDED WITH THE PBLTX AND (L_{cable}) IS THE INDUCTANCE OF ANY ADDITIONAL END USER CABLE THAT IS WIRED TO THE PBLTX. WHEN PROVIDED WITH POLYURETHANE CABLE, THE CAPACITANCE (C_{ext cable}) IS 96 pF/FT (315pF/M) AND INDUCTANCE (L_{ext cable}) IS 346nH/FT (1.135uH/M). WHEN PROVIDED WITH ETFE CABLE, THE CAPACITANCE (C_{ext cable}) 162pF/FT (532 pF/M) AND INDUCTANCE (L_{ext cable}) IS 340 nH/FT (1.116uH/M). WHERE CABLE CAPACITANCE AND INDUCTANCE PER UNIT LENGTH ARE NOT KNOWN, THE CAPACITANCE OF 609pF/FT (200pF/M) AND INDUCTANCE OF 0.2uH/FT (1.0 uH/M) MAY BE USED. PLEASE NOTE THAT THE PBLTX CABLE LENGTH IS SPECIFIED WITHIN THE NOMECLATURE, SEE ITEM "ccc" FOR LENGTH AND ITEM "d" FOR UNIT OF LENGTH. THIS LENGTH WILL NEED TO BE MULTIPLIED BY THE CORRECT PARAMETER (C_{ext cable}) AND (L_{ext cable}) SPECIFIED ABOVE, BASED ON THE CABLE PROVIDED, SEE NOMECLATURE ITEM "e" FOR THE DEVICE'S CABLE TYPE.
3. THE ASSOCIATED APPARATUS INSTALLATION INSTRUCTIONS MUST BE FOLLOWED WHEN INSTALLING THE EQUIPMENT.
4. WARNING - ALL FIELD WIRING SHALL BE SUITABLE FOR AN AMBIENT TEMPERATURE RANGE OF -20° TO 80°C.
5. THE CABLE USED IN THIS DEVICE HAS A VENT TUBE. THEREFORE THE CABLE ATTACHED TO THE PBLTX SHALL BE TERMINATED IN THE HAZARDOUS AREA.
6. NO REVISIONS TO THIS DRAWING WITHOUT PRIOR APPROVAL BY UL/DEWKO.
7. TRANSDUCE MUST BE INSTALLED IN ACCORDANCE TO IEC/EN 60079-14 OR ANY LOCAL INSTALLATION CODES/REQUIREMENTS.

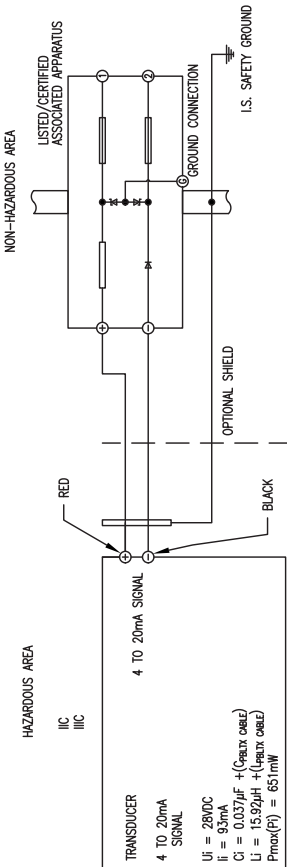

ATEX CLASSIFICATION: I I G Ex ia IIC T4 Ga (-20°C ≤ Tamb ≤ 80°C (ETFE CABLE)) (-20°C ≤ Tamb ≤ 65°C (POLYURETHANE CABLE))
 I I D Ex ia IIC T1.35°C Da (-20°C ≤ Tamb ≤ 80°C (ETFE CABLE)) (-20°C ≤ Tamb ≤ 65°C (POLYURETHANE CABLE))

IECEx CLASSIFICATION: Ex ia IIC T4 Ga (-20°C ≤ Tamb ≤ 80°C (ETFE CABLE)) (-20°C ≤ Tamb ≤ 65°C (POLYURETHANE CABLE))
 Ex ia IIC T1.35°C Da (-20°C ≤ Tamb ≤ 80°C (ETFE CABLE)) (-20°C ≤ Tamb ≤ 65°C (POLYURETHANE CABLE))

ATEX STANDARDS: EN 60079-0:2012(A11:2013)
 EN 60079-11:2012

IEC STANDARDS: IEC 60079-0:2011 6TH ED.
 IEC 60079-11:2011 6TH ED.

- BLANK(STANDARD) OR 2YR(2 YEAR WARRANTY) WARRANTY TYPE
- ATEX (ATEX/IECEx COMPLIANT) CONFIGURATION
- BLANK(ETFE CABLE) OR PU(POLYURETHANE CABLE) CABLE TYPE
- BLANK(FEET) OR M(METERS) CABLE UNITS
- ONE TO THREE DIGIT NUMERIC CHARACTER
- 1 TO 470(FEET) OR 1 TO 143(METERS) FOR POLYURETHANE CABLE.
- 1 TO 275(FEET) OR 1 TO 84(METERS) FOR ETFE CABLE CABLE LENGTH
- BLANK(PS) OR M(METERS) RANGE UNITS
- ONE TO FIVE DIGIT NUMERIC CHARACTER,
- 5 TO 145(FEET)
- 3.5 TO 100 METERS OF WC SENSOR RANGE

ZONE AND DIVISION ENTRY PARAMETERS ARE SHOWN AS: DIVISION (ZONE)

ASSOCIATED APPARATUS

Voc (Vo) ≤ 28V

Isc (Io) ≤ 93mA

Power (Po) ≤ 0.651W

Ca (Co) ≥ 0.037uF + (C_{ext cable}) + (C_{cable})

La (Lo) ≥ 15.92uH + (L_{ext cable}) + (L_{cable})

⊕ = CRITICAL DIMENSION
 DIMENSIONS IN PARENTHESES UNLESS NOTED:
 ALL DECIMAL DIMENSIONS ± .003
 ALL ANGLES ± 1°

NO.	CHANGES	DATE	NAME	MATERIAL
2	ADDED ATEX CONFIGURATION PER EDR #045704	JEO 12-10-18	DWN BY AMS	FINISH
1	GENERAL REVISION AS REQUESTED BY UL PER EDR #4310	RBS 6-20-18	CHKD DGH	
0	INITIAL RELEASE NO-005145	AMS 02-28-18	APFD LR	
NO.				

I.S. CONTROL DRAWING
 ATEX/IECEx

PBLTX

ACAD2002

3

NOTICE: This drawing and the principles and elements of design embodied therein are the exclusive property of DWYER INSTRUMENTS, INC. and are not to be used, copied, reproduced, or otherwise disseminated without the written consent of DWYER INSTRUMENTS, INC. Any use of this drawing or its contents without the written consent of DWYER INSTRUMENTS, INC. is prohibited.

DWYER INSTRUMENTS, INC.
 MICHIGAN CITY, INDIANA 46360 U.S.A.

FR. NO. 001833-47



Transducteur de niveau submersible série PBLTX

Spécifications - Installation et mode d'emploi

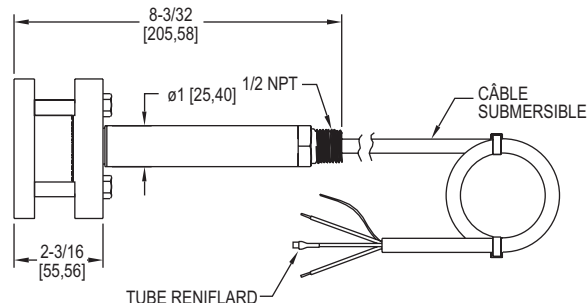
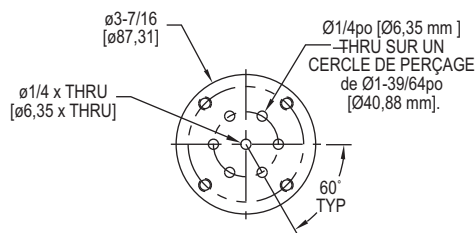

Le transducteur de niveau submersible série PBLTX est conçu pour des années de service sans souci dans les applications les plus difficiles. Le modèle PBLTX mesure la hauteur du liquide au-dessus de sa position dans le réservoir référencé à la pression atmosphérique. Le transducteur est constitué d'un élément de détection piézorésistif, enveloppé dans un corps en acier inoxydable 316. Idéal pour les applications d'eaux usées et de boue, il possède des caractéristiques pour protéger l'unité contre ces applications exigeantes. Le joint à membrane de grand diamètre en acier inoxydable 316 protège des obstructions et résiste aux dommages liés aux matières flottantes.

Il est équipé d'un câble à résistance à la traction de 270 lb (123 kg), blindé et ventilé. Le tube de mise à l'air libre du câble compense automatiquement les variations de pression atmosphérique au-dessus du réservoir. L'évent est protégé par un filtre sans entretien éliminant les particules ou les gouttelettes d'eau qui pénètrent dans le transducteur.

Classification d'homologation de sécurité intrinsèque

Le modèle PBLTX est enregistré UL pour une utilisation dans les zones dangereuses (classées). La méthode de protection est la sécurité intrinsèque, « ia ». Elle a été étudiée par UL en vertu de la norme UL 913 8e édition, CAN/CSA C22.2 n° 60079-0:15 et CAN/CSA C22.2 n° 60079-11:14.

Zone dangereuse (classée) à sécurité intrinsèque pour :

Classe I Div. 1 groupes A, B, C, D

Classe II Div. 1 groupes E, F, G

Classe III Div. 1

Classe I Zone 0 AEx ia IIC T4 Ga

Zone 20 AEx ia IIIC T135 °C Da

Ex ia IIC T4 Ga

Ex ia IIIC T135 °C Da

Ta = -20 °C à 80 °C (câble ETFE)

Ta = -20 °C à 65 °C (câble en polyuréthane)

Installer conformément au schéma de contrôle 001833-44.

Voir le schéma de contrôle 001833-44 pour les paramètres d'entité.

ATEX : Certificat de type UE n° DEMKO 18 ATEX 2080

NORMES ATEX : EN 60079-0:2012/A11:2013

EN 60079-11:2012

CLASSIFICATION ATEX : **CE** 0518 **Ex** II 1 G Ex ia IIC T4 Ga (-20 °C ≤ Tamb ≤ 80 °C (câble ETFE)) (-20 °C ≤ Tamb ≤ 65 °C (câble en polyuréthane))

CE 0518 **Ex** II 1 D Ex ia IIIC T135 °C Da (-20 °C ≤ Tamb ≤ 80 °C (câble ETFE))

(-20 °C ≤ Tamb ≤ 65 °C (câble en polyuréthane))

Certificat de conformité IECEx : IECEx UL 18.0086

NORMES IECEx : CEI 60079-0: 2011 6E ÉD.

CEI 60079-11:2011 6E ÉD.

CLASSIFICATION IECEx : Ex ia IIC T4 Ga (-20 °C ≤ Tamb ≤ 80 °C (câble ETFE))

(-20 °C ≤ Tamb ≤ 65 °C (câble en polyuréthane))

Ex ia IIIC T135 °C Da (-20 °C ≤ Tamb ≤ 80 °C (câble ETFE)) (-20 °C ≤ Tamb ≤ 65 °C (câble polyuréthane))

(câble polyuréthane))

Installer conformément au schéma de contrôle 001833-47

VOIR LE SCHÉMA DE CONTRÔLE 001833-47 POUR LES PARAMÈTRES D'ENTITÉ.

SPÉCIFICATIONS

Service : Liquides compatibles.

Matériaux mouillés : Corps : acier inoxydable 316, acier inoxydable 316L ; Câble : polyéther polyuréthane ou ETFE ; Joints : fluoroélastomère.

Précision : ± 0,25 % FS.

Limite de température : Câble ETFE équipé : -4 à 176 °F (-20 à 80 °C) ; Câble en polyuréthane équipé : -4 à 149 °F (-20 à 65 °C).

Plage de températures compensées : -4 à 176 °F (-20 à 80 °C)

Effet thermique : Moins de ± 0,02 %/FS/°F.

Limite de pression : 2X FS.

Puissance électrique nécessaire : 10 à 28 VCC.

Signal en sortie : 4 à 20 mA CC, deux fils.

Temps de réponse : 50 msec.

Résistance max. de la boucle : 900 Ω.

Raccordement électrique : Raccord flexible.

Orientation de montage : Suspendu dans le réservoir au-dessous du niveau étant mesuré. Peut être placé sur le fond du réservoir sur le côté.

Poids : 4,3 lb (2,0 kg).

Homologations : CE, Voir Classification d'homologation de sécurité intrinsèque.



AVERTISSEMENT

Utiliser avec des barrières de sécurité approuvées en utilisant l'évaluation de l'entité.

MISE EN GARDE :

Ne pas dépasser les tensions d'alimentation nominales spécifiées. Le non-respect de cette consigne entraînera des dommages permanents non couverts par la garantie. Ce dispositif n'est pas conçu pour un fonctionnement à 120 ou 240 VCA. Utiliser uniquement à 10 à 28 VCC.

INSTALLATION

1. Emplacement : Sélectionner un emplacement où la température du transducteur se situera entre -4 et 176 °F (-20 et 80 °C) pour le câble ETFE ou -4 et 149 °F (-20 et 65 °C) pour le câble en polyuréthane. La distance à partir du récepteur est uniquement limitée par la résistance totale de la boucle.

2. Position : Le transducteur peut se positionner librement. Toutefois, tous les modèles standard sont à l'origine étalonnés avec l'unité dans une position orientant la membrane vers le bas. Bien qu'ils puissent être utilisés sous d'autres angles, pour une meilleure précision, il est recommandé que les unités soient installées dans la position étalonnée à l'usine.

3. Montage : Le transducteur peut être monté par plusieurs méthodes. Il peut être suspendu au câble électrique, il peut être placé reposant sur le fond du réservoir en orientation horizontale ou verticale, ou il peut être fixé à un tuyau ou en accrochant le fil près du raccord mâle de 1/2 po NPT sur la partie supérieure du corps.

4. Longueur de câble : La longueur maximale du câble de raccordement du transducteur au récepteur dépend de la taille du câble et de la résistance du récepteur. Le câblage ne doit pas contribuer à plus de 10 % de la résistance du récepteur par rapport à la résistance totale de la boucle. Pour les longues distances (supérieures à 1 000 pieds [304,8 mm]), choisir des récepteurs avec une résistance plus élevée afin de réduire la taille et le coût des câbles de raccordement. Lorsque la longueur de câble est inférieure à 100 pieds (30,5 m), un fil aussi petit que 22 AWG peut être utilisé.

5. Câblage : Une alimentation externe fournissant entre 10 et 28 VCC avec une capacité de courant minimum de 40 mA CC (par transducteur) est nécessaire pour alimenter la boucle de contrôle. Voir figure A pour le raccordement à l'alimentation électrique, transducteur et récepteur. La plage de charge de résistance appropriée du récepteur (RL) pour la tension d'alimentation CC disponible s'exprime par la formule suivante :

$$R_L \text{ Max} = \frac{V_{ps} - 10 \text{ V}}{20 \text{ mA CC}}$$

L'utilisation d'un câble blindé est recommandé pour le câblage à boucle de contrôle.

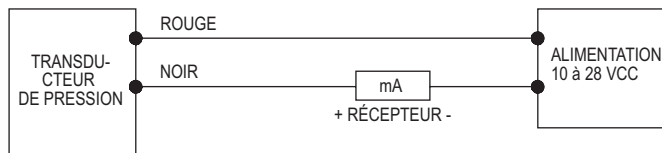

Figure A

Le fil noir est négatif (-) et le fil rouge est positif (+) à la figure B.

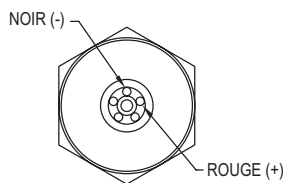

Figure B

ENTRETIEN

Après l'installation finale du transducteur de pression et de son récepteur aucun entretien de routine n'est nécessaire. Une vérification périodique de l'étalonnage du système est suggérée. Les transducteurs série PBLTX ne sont pas réparables sur site et doivent être retournés si des réparations sont nécessaires (les tentatives de réparation peuvent annuler la garantie). Prendre soin d'inclure une brève description du problème ainsi que toute remarque utile sur les conditions d'utilisation. Contacter le service client pour recevoir un numéro d'autorisation de retour de marchandise avant de procéder au renvoi.

- NOTES:**
1. SELECTED ASSOCIATED APPARATUS MUST BE THIRD PARTY LISTED AS PROVIDING INTRINSICALLY SAFE CIRCUITS FOR THE APPLICATION, AND NOT EXCEED THE ENTITY PARAMETERS LISTED IN THIS DRAWING.
 2. ASSOCIATED APPARATUS OUTPUT CURRENT MUST BE LIMITED BY A RESISTOR SUCH THAT THE OUTPUT VOLTAGE-CURRENT PLOT IS A STRAIGHT LINE DRAWN BETWEEN OPEN-CIRCUIT VOLTAGE AND SHORT-CIRCUIT CURRENT.
 3. CAPACITANCE AND INDUCTANCE OF THE FIELD WIRING FROM THE INTRINSICALLY SAFE TRANSDUCER TO THE ASSOCIATED APPARATUS SHALL BE CALCULATED AND MUST INCLUDE THE SYSTEM CALCULATIONS AS SHOWN WITHIN THIS DRAWING. TOTAL CAPACITANCE IS CALCULATED BY ADDING BOTH (C_{EXT CABL}) AND (C_{CABL}) TO C_I, WHERE (C_{EXT CABL}) IS THE CAPACITANCE OF FACTORY WIRING PROVIDED WITH THE PBLTX AND (C_{CABL}) IS CAPACITANCE OF ANY ADDITIONAL END USER CABLE THAT IS WIRED TO THE PBLTX. TOTAL INDUCTANCE IS CALCULATED BY ADDING BOTH (L_{EXT CABL}) AND (L_{CABL}) TO L_I, WHERE (L_{EXT CABL}) IS THE INDUCTANCE OF FACTORY WIRING PROVIDED WITH THE PBLTX AND (L_{CABL}) IS THE INDUCTANCE OF ANY ADDITIONAL END USER CABLE THAT IS WIRED TO THE PBLTX. WHEN PROVIDED WITH POLYURETHANE CABLE, THE CAPACITANCE (C_{EXT CABL}) IS 96 pF/FT (315pF/M) AND INDUCTANCE (L_{EXT CABL}) IS 346pH/FT (1.135μH/M). WHEN PROVIDED WITH ETFE CABLE, THE CAPACITANCE (C_{EXT CABL}) IS 162pF/FT (532 pF/M) AND INDUCTANCE (L_{EXT CABL}) IS 340 nH/FT (1.119μH/M), WHERE CABLE CAPACITANCE AND INDUCTANCE PER UNIT LENGTH ARE NOT KNOWN, THE CAPACITANCE OF 609pF/FT (200pF/M) AND INDUCTANCE OF 0.2μH/FT (1.0 μH/M) MAY BE USED. PLEASE NOTE THAT THE PBLTX CABLE LENGTH IS SPECIFIED WITHIN THE NOMENCLATURE, SEE ITEM "C" FOR LENGTH AND ITEM "d" FOR UNIT OF LENGTH. THIS LENGTH WILL NEED TO BE MULTIPLIED BY THE CORRECT PARAMETER (C_{EXT CABL}) AND (L_{EXT CABL}) AS SPECIFIED ABOVE, BASED ON THE CABLE PROVIDED. SEE NOMENCLATURE ITEM "e" FOR THE DEVICE'S CABLE TYPE.
 4. TRANSDUCERS MUST BE INSTALLED TO THE MANUFACTURER'S CONTROL DRAWING AND ARTICLE 504 OF THE NATIONAL ELECTRICAL CODE (ANSI/NFPA 70) FOR INSTALLATION IN THE UNITED STATES OR SECTION 18 OF THE CANADIAN ELECTRICAL CODE (CSA C22.1) FOR INSTALLATION IN CANADA OR OTHER LOCAL INSTALLATION CODES, AS APPLICABLE.
 5. THE ASSOCIATED APPARATUS MANUFACTURER'S INSTALLATION INSTRUCTIONS MUST BE FOLLOWED WHEN INSTALLING THE EQUIPMENT.
 6. THE CABLE USED IN THIS DEVICE HAS A VENT TUBE. THEREFORE THE CABLE ATTACHED TO THE PBLTX SHALL BE TERMINATED IN THE HAZARDOUS AREA.
 7. NO REVISIONS TO THIS DRAWING WITHOUT PRIOR APPROVAL BY UL.

STANDARDS:
 AS REFERENCED BY UL 913 - 8th EDITION CAN/CSA C22.2 NO. 60079-0-15
 UL 60079-0 - 6th EDITION CAN/CSA C22.2 NO. 60079-11:14
 UL 60079-11 - 6th EDITION

- PBLTX-300L040H-C200-F-I
- 1. BLANK(STANDARD) OR 2YR(2 YEAR WARRANTY) WARRANTY TYPE
 - 2. BLANK(ETFE CABLE) OR P(POLYURETHANE CABLE) CABLE TYPE
 - 3. BLANK(FEET) OR M(METERS) CABLE UNITS
 - 4. ONE TO THREE DIGIT NUMERIC CHARACTER
 - 5. 1 TO 470(FEET) OR 1 TO 143(METERS) FOR POLYURETHANE CABLE.
 - 6. 1 TO 275(FEET) OR 1 TO 84(METERS) FOR ETFE CABLE CABLE LENGTH
 - 7. BLANK(Ps) OR M(METERS) RANGE UNITS
 - 8. ONE TO FIVE DIGIT NUMERIC CHARACTER,
 - 9. 5 TO 145 PSI OR
 - 10. 3.5 TO 100 METERS OF WC SENSOR RANGE

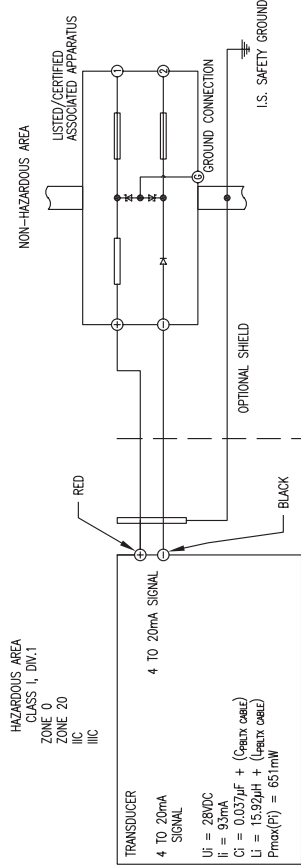

HAZARDOUS (CLASSIFIED) LOCATION INTRINSICALLY SAFE FOR:
 CLASS I DIV1 GROUPS A,B,C,D
 CLASS II DIV1 GROUPS E,F,G
 CLASS III DIV1
 CLASS I ZONE 0 AEx, ia, IIC T4 Gc
 ZONE 20 AEx ia IIC T1,35C Dc
 Ex ia IIC T4 Gc
 Ex ia IIC T1,35C Dc
 To = -20 °C TO 65°C(POLYURETHANE CABLE)
 -20°C TO 80°C(ETFE CABLE)

ASSOCIATED APPARATUS
 Voc (Vo) ≤ 28V
 Isc (Io) ≤ 93mA
 Po (Po) ≤ 0.651W
 Ca (Ca) ≥ 0.037μF + (C_{EXT CABL}) + (C_{CABL})
 La (La) ≥ 15.92μH + (L_{EXT CABL}) + (L_{CABL})

⊕ = CRITICAL DIMENSION
 DIMENSIONS UNLESS NOTED:
 ALL DIMENSIONS ± .005
 ALL ANGLES ± 1°

DATE		02-12-18	
DWN BY		AMS	
RBS		6-20-18	
CHKD		DGH	
AMS		02-28-18	
APPR		LR	
CHANGES			
NO.			
NOTICE: This drawing and the physical and electrical elements of design embodied therein are the exclusive property of DWYER INSTRUMENTS, INC. and are not to be communicated, disclosed, reproduced or used in whole or in part without the prior written consent of DWYER INSTRUMENTS, INC. and are not to be used for examination without the written consent of said corporation.			
MATERIAL		PBLTX CONTROL DRAWING	
FINISH		I.S. CONTROL DRAWING	
DWYER INSTRUMENTS, INC.		AC02002	
MICHIGAN CITY, INDIANA 46360 U.S.A.		3	
FR. NO. 001833-44			

ZONE AND DIVISION ENTITY PARAMETERS ARE SHOWN AS: DIVISION (ZONE)

- 1. SELECTED ASSOCIATED APPARATUS MUST BE THIRD PARTY LISTED AS PROVIDING INTRINSICALLY SAFE CIRCUITS FOR THE APPLICATION, AND NOT EXCEED THE ENTRY PARAMETERS LISTED ON THIS DRAWING.
- 2. CAPACITANCE AND INDUCTANCE OF THE FIELD WIRING FROM THE INTRINSICALLY SAFE TRANSDUCE TO THE ASSOCIATED APPARATUS SHALL BE CALCULATED AND MUST INCLUDE THE SYSTEM CALCULATIONS AS SHOWN WITHIN THIS DRAWING. TOTAL CAPACITANCE IS CALCULATED BY ADDING BOTH (C_{ext cable}) AND (C_{cabl}) TO C, WHERE (C_{ext cable}) IS THE CAPACITANCE OF FACTORY WIRING PROVIDED WITH THE PBLTX AND (C_{cabl}) IS CAPACITANCE OF ANY ADDITIONAL END USER CABLE THAT IS WIRED TO THE PBLTX. TOTAL INDUCTANCE IS CALCULATED BY ADDING BOTH (L_{ext cable}) AND (L_{cabl}) TO L, WHERE (L_{ext cable}) IS THE INDUCTANCE OF FACTORY WIRING PROVIDED WITH THE PBLTX AND (L_{cabl}) IS THE INDUCTANCE OF ANY ADDITIONAL END USER CABLE THAT IS WIRED TO THE PBLTX. WHEN PROVIDED WITH POLYURETHANE CABLE, THE CAPACITANCE (C_{ext cable}) IS 96 pF/FT (315pF/M) AND INDUCTANCE (L_{ext cable}) IS 346nH/FT (1.135nH/M). WHEN PROVIDED WITH ETFE CABLE, THE CAPACITANCE (C_{ext cable}) 162pF/FT (532 pF/M) AND INDUCTANCE (L_{ext cable}) IS 340 nH/FT (1.116nH/M). WHERE CABLE CAPACITANCE AND INDUCTANCE PER UNIT LENGTH ARE NOT KNOWN, THE CAPACITANCE OF 60pF/FT (200pF/M) AND INDUCTANCE OF 0.2µH/FT (1.0 µH/M) MAY BE USED. PLEASE NOTE THAT THE PBLTX CABLE LENGTH IS SPECIFIED WITHIN THE NOMENCLATURE, SEE ITEM "ccc" FOR LENGTH AND ITEM "d" FOR UNIT OF LENGTH. THIS LENGTH WILL NEED TO BE MULTIPLIED BY THE CORRECT PARAMETER (C_{ext cable}) AND (L_{ext cable}) SPECIFIED ABOVE, BASED ON THE CABLE PROVIDED, SEE NOMENCLATURE ITEM "e" FOR THE DEVICE'S CABLE TYPE.
- 3. THE ASSOCIATED APPARATUS INSTALLATION INSTRUCTIONS MUST BE FOLLOWED WHEN INSTALLING THE EQUIPMENT.
- 4. WARNING - ALL FIELD WIRING SHALL BE SUITABLE FOR AN AMBIENT TEMPERATURE RANGE OF -20 TO 80°C.
- 5. THE CABLE USED IN THIS DEVICE HAS A VENT TUBE. THEREFORE THE CABLE ATTACHED TO THE PBLTX SHALL BE TERMINATED IN THE HAZARDOUS AREA.
- 6. NO REVISIONS TO THIS DRAWING WITHOUT PRIOR APPROVAL BY UL/DEWKO.
- 7. TRANSDUCE MUST BE INSTALLED IN ACCORDANCE TO IEC/EN 60079-14 OR ANY LOCAL INSTALLATION CODES/REQUIREMENTS.

ATEX CLASSIFICATION: I G Ex ia IIC T4 Ga (-20°C ≤ Tamb ≤ 80°C (ETFE CABLE)) (-20°C ≤ Tamb ≤ 65°C (POLYURETHANE CABLE))
 I D Ex ia IIC T1.35C Da (-20°C ≤ Tamb ≤ 80°C (ETFE CABLE)) (-20°C ≤ Tamb ≤ 65°C (POLYURETHANE CABLE))

IECEx CLASSIFICATION: Ex ia IIC T4 Ga (-20°C ≤ Tamb ≤ 80°C (ETFE CABLE)) (-20°C ≤ Tamb ≤ 65°C (POLYURETHANE CABLE))
 Ex ia IIC T1.35C Da (-20°C ≤ Tamb ≤ 80°C (ETFE CABLE)) (-20°C ≤ Tamb ≤ 65°C (POLYURETHANE CABLE))

ATEX STANDARDS: EN 60079-0:2012/A11:2013
 EN 60079-11:2012

IEC STANDARDS: IEC 60079-0:2011 6TH ED.
 IEC 60079-11:2011 6TH ED.

- PBLTX-3000-0000-0000-0000-ATEX-I
- BLANK(STANDARD) OR 2YR(2 YEAR WARRANTY) WARRANTY TYPE
- ATEX (ATEX/IECEx COMPLIANT) CONFIGURATION
- BLANK(ETFE CABLE) OR PU(POLYURETHANE CABLE) CABLE TYPE
- BLANK(FeET) OR M(METERS) CABLE UNITS
- ONE TO THREE DIGIT NUMERIC CHARACTER
- 1 TO 470(FEET) OR 1 TO 143(METERS) FOR POLYURETHANE CABLE.
- 1 TO 275(FEET) OR 1 TO 84(METERS) FOR ETFE CABLE LENGTH
- BLANK(Ps) OR M(METERS) RANGE UNITS
- ONE TO FIVE DIGIT NUMERIC CHARACTER,
- 5 TO 145(FEET)
- 3.5 TO 100 METERS OF WC SENSOR RANGE

ZONE AND DIVISION ENTRY PARAMETERS ARE SHOWN AS: DIVISION (ZONE)

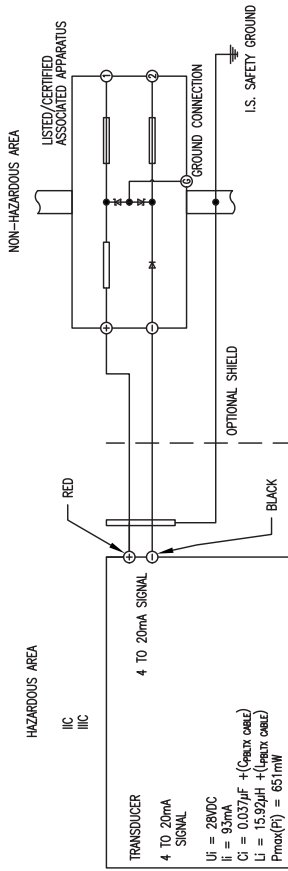

ASSOCIATED APPARATUS

Voc (Vo) ≤ 28V

Isc (Io) ≤ 93mA

Po (Po) ≤ 0.651W

Ca (Ca) ≥ 0.037µF + (C_{ext cable}) + (C_{cabl})

La (La) ≥ 15.92µH + (L_{ext cable}) + (L_{cabl})

⊕ = CRITICAL DIMENSION
 DIMENSIONS UNLESS OTHERWISE NOTED:
 ALL DECIMAL DIMENSIONS ± .003
 ALL ANGLES ± 1°

MATERIAL		DATE	NAME
2	ADDED ATEX CONFIGURATION PER EDR #045704	02-14-18	PBLTX
1	GENERAL REVISION AS REQUESTED BY UL PER EDR #4310	12-10-18	I.S. CONTROL DRAWING
0	INITIAL RELEASE NO-005145	6-20-18	ATEX/IECEx
NO.	CHANGES	02-28-18	
		BY/DATE	LR
		APPD	
		DWN BY	AMS
		CHKD	DGH
		ACAD2002	
		3	

NOTICE: This drawing and the principles and elements of design embodied therein are the exclusive property of DWYER INSTRUMENTS, INC. and are not to be reproduced, stored in a retrieval system, or transmitted, in any form or by any means, without the written consent of DWYER INSTRUMENTS, INC. and are not to be used for any purpose other than that specifically authorized in writing by such corporation and must not be submitted to outside parties.

DWYER INSTRUMENTS, INC.
 MICHIGAN CITY, INDIANA 46360 U.S.A.

FR. NO. 001833-47



Transductor de nivel sumergible de la serie PBLTX

Especificaciones: instrucciones de instalación y uso

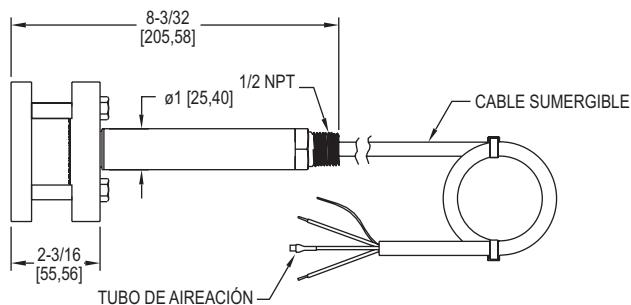
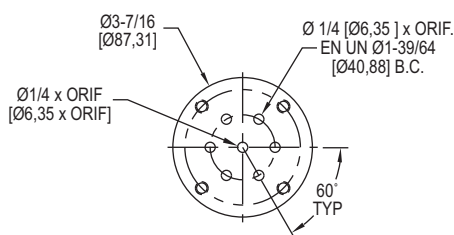

El transductor de nivel sumergible de la serie PBLTX se fabrica para que preste servicio durante años sin dar problemas en las aplicaciones más duras. El PBLTX mide la altura del líquido por encima de su posición en el depósito tomando la presión atmosférica como referencia. El transductor consta de un elemento de detección piezorresistivo que está alojado en una carcasa de 316 SS. Perfecto para aplicaciones en aguas residuales y lodos con prestaciones que protegen la unidad de estas exigentes aplicaciones. La junta de diafragma de gran diámetro de 316 SS no se obstruye y es resistente a los sólidos flotantes.

Viene equipado con un cable apantallado y ventilado que tiene una resistencia de 270 libras a la tracción. El tubo de ventilación del interior del cable compensa automáticamente los cambios de presión atmosférica existentes por encima del depósito. El respiradero está protegido por un filtro que no necesita mantenimiento y elimina las partículas o gotas de agua que entran en el transductor.

Clasificación de la certificación de seguridad intrínseca

El PBLTX está homologado por UL para su uso en ubicaciones peligrosas (clasificadas). El método de protección es por seguridad intrínseca, "ia". Fue investigado por UL según la norma UL 913 8.ª edición, CAN/CSA C22.2 n.º 60079-0:15 y CAN/CSA C22.2 n.º 60079-11:14.

Ubicación (clasificada como) peligrosa intrínsecamente segura para:

Clase I Div. 1 Grupos A, B, C, D

Clase II Div. 1 Grupos E, F, G

Clase III Div. 1

Clase I Zona 0 AEx ia IIC T4 Ga

Zona 20 AEx ia IIIC T135 °C Da

Ex ia IIC T4 Ga

Ex ia IIIC T135 °C Da

Ta = entre -20 °C y 80 °C (cable de ETFE)

Ta = entre -20 °C y 65 °C (cable de poliuretano)

Instálese conforme al esquema de control 001833-44.

Consulte en el esquema de control 001833-44 los parámetros de entidad.

ATEX: Certificado de tipo EU N° DEMKO 18 ATEX 2080

NORMAS ATEX: EN 60079-0:2012/A11:2013

EN 60079-11:2012

CLASIFICACIÓN ATEX: **CE** 0518 **Ex** II 1 G Ex ia IIC T4 Ga (-20 °C ≤ Tamb ≤ 80 °C

(cable de ETFE)) (-20 °C ≤ Tamb ≤ 65 °C (cable de poliuretano))

CE 0518 **Ex** II 1 D Ex ia IIIC T135 °C Da (-20 °C ≤ Tamb ≤ 80 °C (cable de ETFE))

(-20 °C ≤ Tamb ≤ 65 °C (cable de poliuretano))

Certificado de cumplimiento IECEx: IECEx UL 18.0086

NORMAS IECEx: IEC 60079-0: 2011 6.ª ED.

IEC 60079-11:2011 6.ª ED.

CLASIFICACIÓN IECEx: Ex ia IIC T4 Ga (-20 °C ≤ Tamb ≤ 80 °C (cable de ETFE))

(-20 °C ≤ Tamb ≤ 65 °C (cable de poliuretano))

Ex ia IIIC T135 °C Da (-20 °C ≤ Tamb ≤ 80 °C (cable de ETFE)) (-20 °C ≤ Tamb

≤ 65 °C (cable de poliuretano))

Instálese conforme al esquema de control 001833-47

PARA VER LOS PARÁMETROS DE ENTIDAD, CONSULTE EL ESQUEMA 001833-47.

ESPECIFICACIONES

Mantenimiento: líquidos compatibles.

Materiales humedecidos: cuerpo: 316 SS, 316L SS; cable: poliuretano con base de poliéster o ETFE; juntas: fluoroelastómero.

Precisión: ±0,25 % FS.

Límite de temperatura: cable de ETFE suministrado entre -4 y 176 °F (-20 y 80 °C); cable de poliuretano suministrado entre -4 y 149 °F (-20 y 65 °C).

Rango de temperatura compensado: entre -4 y 176 °F (-20 y 80 °C).

Efecto térmico: menos de ±0,02 %/ FS/ °F.

Límite de presión: 2X FS.

Potencia requerida: 10-28 V CC.

Señal de salida: 4-20 mA CC, dos cables.

Tiempo de respuesta: 50 ms.

Máx. Resistencia de bucle: 900 Ω.

Conexión eléctrica: espiral de cable.

Orientación para el montaje: suspendido dentro del depósito por debajo del nivel que se está midiendo. Se puede colocar en la parte inferior del depósito a su lado.

Peso: 4,3 lb (2,0 kg).

Certificaciones de agencia: CE, consulte la Clasificación de la certificación de seguridad intrínseca.



ADVERTENCIA

Empléese con barreras de seguridad autorizadas utilizando la evaluación de entidades.

⚠ PRECAUCIÓN

No sobrepase los valores de tensión de alimentación especificados. Se producirán daños permanentes que no están cubiertos por la garantía. Este dispositivo no está diseñado para funcionar a una CA de 120 o 240 voltios. Utilícese solamente a 10-28 V CC.

MANTENIMIENTO

Después de la instalación definitiva del transductor de presión y su receptor complementario, no es necesario realizar el mantenimiento de rutina. Se sugiere realizar periódicamente la revisión de la calibración del sistema. Los transductores de la serie PBLTX no son reparables in situ y deben devolverse si es necesario repararlos (no debe intentarse realizar la reparación in situ, lo que podría anular la garantía). Asegúrese de incluir una breve descripción del problema, además de notas pertinentes sobre la aplicación. Para obtener un número de autorización de devolución de productos antes del envío, póngase en contacto con el servicio de atención al cliente.

INSTALACIÓN

1. Ubicación: seleccione un lugar donde la temperatura del transductor esté entre -4 y 176 °F (-20 y 80 °C) para el cable de ETFE o entre -4 y 149 °F (-20 y 65 °C) para el cable de poliuretano. La distancia desde el receptor solo está limitada por la resistencia de bucle total.

2. Posición: el transductor no es sensible a la posición. Sin embargo, todos los modelos estándar están calibrados originalmente con la unidad en una posición con el diafragma hacia abajo. Aunque se pueden utilizar en otros ángulos, para que la precisión sea mayor se recomienda que las unidades se instalen en la posición calibrada en la fábrica.

3. Montaje: el transductor se puede montar utilizando varios métodos. Se puede suspender del cable eléctrico, se puede colocar descansando en la parte inferior del depósito con una orientación horizontal o vertical, o se puede conectar a una tubería o colgar el cable por la conexión macho 1/2" NPT en la parte superior de la carcasa.

4. Longitud del cable: la longitud máxima del cable que conecta el transductor y el receptor depende del tamaño del cable y de la resistencia del receptor. El cableado no debe contribuir a la resistencia de bucle total en más del 10 % de la resistencia del receptor. Para distancias extremadamente largas (más de 1000 pies [304 m]), elija receptores que tengan una resistencia superior, para minimizar el tamaño y el coste de los cables de conexión. Cuando la longitud del cableado es inferior a 100 pies (30 m), se puede utilizar un cable de pequeño calibre de 22 AWG.

5. Cableado: para alimentar el bucle de control, hay que tener un suministro de alimentación externo que proporcione 10-28 V CC con una capacidad de corriente mínima de 40 mA CC (por transductor). Vea en la Figura A la conexión del suministro de alimentación, el transductor y el receptor. El rango de la resistencia adecuada de la carga del receptor (RL) para el suministro de alimentación de CC disponible se expresa mediante la siguiente fórmula:

$$RL \text{ Máx} = \frac{V_{ps} - 10 \text{ V}}{20 \text{ mA CC}}$$

Para controlar el cableado de bucle se recomienda utilizar un cable apantallado.



Figura A

En la Figura B, el cable negro es negativo (-) y el cable rojo es positivo (+).

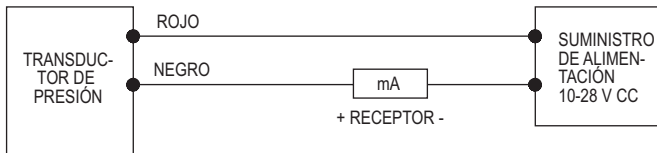

Figura B

NOTES:
 1. SELECTED ASSOCIATED APPARATUS MUST BE THIRD PARTY LISTED AS PROVIDING INTRINSICALLY SAFE CIRCUITS FOR THE APPLICATION AND NOT EXCEED THE ENTITY PARAMETERS LISTED IN THIS DRAWING.
 2. ASSOCIATED APPARATUS OUTPUT CURRENT MUST BE LIMITED BY A RESISTOR SUCH THAT THE OUTPUT VOLTAGE-CURRENT PLOT IS A STRAIGHT LINE DRAWN BETWEEN OPEN-CIRCUIT VOLTAGE AND SHORT-CIRCUIT CURRENT.
 3. CAPACITANCE AND INDUCTANCE OF THE FIELD WIRING FROM THE INTRINSICALLY SAFE TRANSUCER TO THE ASSOCIATED APPARATUS SHALL BE CALCULATED AND MUST INCLUDE THE SYSTEM CALCULATIONS AS SHOWN WITHIN THIS DRAWING. TOTAL CAPACITANCE IS CALCULATED BY ADDING BOTH (C_{EXT CABL}) AND (C_{CABL}) TO C₁ WHERE (C_{EXT CABL}) IS THE CAPACITANCE OF FACTORY WIRING PROVIDED WITH THE PBLTX AND (C_{CABL}) IS CAPACITANCE OF ANY ADDITIONAL END USER CABLE THAT IS WIRED TO THE PBLTX. TOTAL INDUCTANCE IS CALCULATED BY ADDING BOTH (L_{EXT CABL}) AND (L_{CABL}) TO L₁ WHERE (L_{EXT CABL}) IS THE INDUCTANCE OF FACTORY WIRING PROVIDED WITH THE PBLTX AND (L_{CABL}) IS THE INDUCTANCE OF ANY ADDITIONAL END USER CABLE THAT IS WIRED TO THE PBLTX. WHEN PROVIDED WITH POLYURETHANE CABLE, THE CAPACITANCE (C_{EXT CABL}) IS 96 pF/FT (315pF/M) AND INDUCTANCE (L_{EXT CABL}) IS 346pH/FT (1.135µH/M). WHEN PROVIDED WITH ETEE CABLE, THE CAPACITANCE (C_{EXT CABL}) IS 162pF/FT (532 pF/M) AND INDUCTANCE (L_{EXT CABL}) IS 340 nH/FT (1.119µH/M). WHERE CABLE CAPACITANCE AND INDUCTANCES PER UNIT LENGTH ARE NOT KNOWN, THE CAPACITANCE OF 60pF/FT (200pF/M) AND INDUCTANCE OF 0.2µH/FT (1.0 µH/M) MAY BE USED. PLEASE NOTE THAT THE PBLTX CABLE LENGTH IS SPECIFIED WITHIN THE NOMENCLATURE, SEE ITEM "C" FOR LENGTH AND ITEM "d" FOR UNIT OF LENGTH. THIS LENGTH WILL NEED TO BE MULTIPLIED BY THE CORRECT PARAMETER (C_{EXT CABL}) AND (L_{EXT CABL}) SPECIFIED ABOVE, BASED ON THE CABLE PROVIDED. SEE NOMENCLATURE ITEM "e" FOR THE DEVICE'S CABLE TYPE.

4. TRANSUCERS MUST BE INSTALLED TO THE MANUFACTURER'S CONTROL DRAWING AND ARTICLE 504 OF THE NATIONAL ELECTRICAL CODE (ANSI/NFPA 70) FOR INSTALLATION IN THE UNITED STATES OR SECTION 18 OF THE CANADIAN ELECTRICAL CODE (CSA C22.1) FOR INSTALLATION IN CANADA OR OTHER LOCAL INSTALLATION CODES, AS APPLICABLE.
 5. THE ASSOCIATED APPARATUS MANUFACTURER'S INSTALLATION INSTRUCTIONS MUST BE FOLLOWED WHEN INSTALLING THE EQUIPMENT.
 6. THE CABLE USED IN THIS DEVICE HAS A VENT TUBE. THEREFORE THE CABLE ATTACHED TO THE PBLTX SHALL BE TERMINATED IN THE HAZARDOUS AREA.
 7. NO REVISIONS TO THIS DRAWING WITHOUT PRIOR APPROVAL BY UL.

STANDARDS:
 AS REFERENCE BY UL 913 - 8th EDITION CAN/CSA C22.2 NO. 60079-0-15
 UL 60079-0 - 6th EDITION CAN/CSA C22.2 NO. 60079-11:14
 UL 60079-11 - 6th EDITION

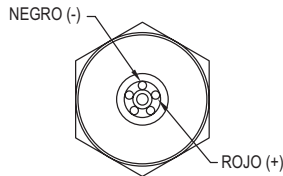
PBLTX-3000-0000-0000-00-1
 L BLANK(STANDARD) OR 2YR(2 YEAR WARRANTY) WARRANTY TYPE
 L BLANK(ETFE CABLE) OR P(POLYURETHANE CABLE) CABLE TYPE
 L BLANK(FEET) OR M(METERS) CABLE UNITS
 L ONE TO THREE DIGIT NUMERIC CHARACTER
 L 1 TO 470(FEET) OR 1 TO 143(METERS) FOR POLYURETHANE CABLE.
 L 1 TO 275(FEET) OR 1 TO 84(METERS) FOR ETFE CABLE CABLE LENGTH
 L BLANK(PS) OR M(METERS) RANGE UNITS
 L ONE TO FIVE DIGIT NUMERIC CHARACTER,
 5 TO 145 PSI OR
 3.5 TO 100 METERS OF WC SENSOR RANGE

HAZARDOUS (CLASSIFIED) LOCATION INTRINSICALLY SAFE FOR:
 CLASS I DIV.1 GROUPS A,B,C,D
 CLASS II DIV.1 GROUPS E,F,G
 CLASS III DIV.1
 CLASS I ZONE 0 AEx ia IIC T4 Gc
 ZONE 20 AEx ia IIC T1.35C Dc
 Ex ia IIC T4 Gc
 Ex ia IIC T1.35C Dc
 T₀ = -20 °C TO 65°C(POLYURETHANE CABLE)
 -20°C TO 80°C(ETFE CABLE)

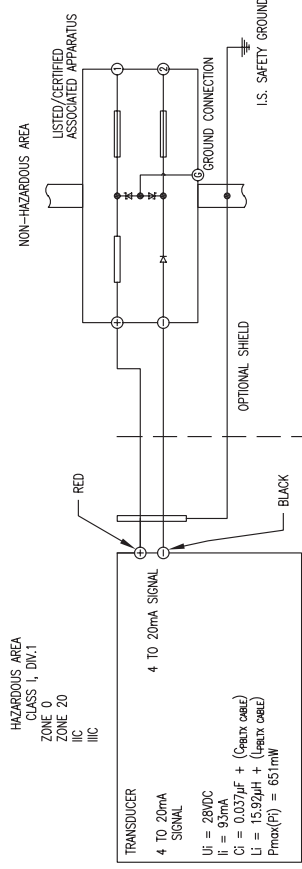

⊕ = CRITICAL DIMENSION
 DIMENSIONS UNLESS NOTED:
 ALL DIMENSIONS IN INCHES UNLESS NOTED:
 ALL ANGLES ± 1°

DATE	NAME	DATE	NAME
02-12-18	DWN BY AMS		
	RBS	6-20-18	CHKD
1	GENERAL REVISION AS REQUESTED BY UL PER ECR #43410	AMS	DGH
0	INITIAL RELEASE NO-005145	02-28-18	APFD
	CHANGES	BY/DATE	LR
NO.			

PBLTX CONTROL DRAWING	
FINISH	
MATERIAL	
AC022002	
FR. NO. 001833-44	
3	

ZONE AND DIVISION ENTITY PARAMETERS ARE SHOWN AS: DIVISION (ZONE)

DWYER INSTRUMENTS, INC.
 MICHIGAN CITY, INDIANA 46360 U.S.A.

001833-44

001833-44

NOTES:
1. SELECTED ASSOCIATED APPARATUS MUST BE THIRD PARTY LISTED AS PROVIDING INTRINSICALLY SAFE CIRCUITS FOR THE APPLICATION, AND NOT EXCEED THE ENTRY PARAMETERS LISTED ON THIS DRAWING.

2. CAPACITANCE AND INDUCTANCE OF THE FIELD WIRING FROM THE INTRINSICALLY SAFE TRANSDUCER TO THE ASSOCIATED APPARATUS SHALL BE CALCULATED AND MUST INCLUDE THE SYSTEM CALCULATIONS AS SHOWN WITHIN THIS DRAWING. TOTAL CAPACITANCE IS CALCULATED BY ADDING BOTH (C_{EXT} CABLE) AND (C_{EXT} TO C), WHERE (C_{EXT} CABLE) IS THE CAPACITANCE OF FACTORY WIRING PROVIDED WITH THE PBLTX AND (C_{EXT} TO C) IS THE CAPACITANCE OF ANY ADDITIONAL END USER CABLE THAT IS WIRED TO THE PBLTX. INDUCTANCE IS CALCULATED BY ADDING BOTH (L_{EXT} CABLE) AND (L_{EXT} TO L), WHERE (L_{EXT} CABLE) IS THE INDUCTANCE OF FACTORY WIRING PROVIDED WITH THE PBLTX AND (L_{EXT} TO L) IS THE INDUCTANCE OF ANY ADDITIONAL END USER CABLE THAT IS WIRED TO THE PBLTX. WHEN PROVIDED WITH POLYURETHANE CABLE, THE CAPACITANCE (C_{EXT} CABLE) IS 96 pF/FT (315pF/M) AND INDUCTANCE (L_{EXT} CABLE) IS 346nH/FT (1.135uH/M). WHEN PROVIDED WITH ETFE CABLE, THE CAPACITANCE (C_{EXT} CABLE) 162pF/FT (532 pF/M) AND INDUCTANCE (L_{EXT} CABLE) IS 340 nH/FT (1.116uH/M). WHERE CABLE CAPACITANCE AND INDUCTANCE PER UNIT LENGTH ARE NOT KNOWN, THE CAPACITANCE OF 60pF/FT (200pF/M) AND INDUCTANCE OF 0.2uH/FT (1.0 uH/M) MAY BE USED. PLEASE NOTE THAT THE PBLTX CABLE LENGTH IS SPECIFIED WITHIN THE NOMENCLATURE, SEE ITEM "ccc" FOR LENGTH AND ITEM "d" FOR UNIT OF LENGTH. THIS LENGTH WILL NEED TO BE MULTIPLIED BY THE CORRECT PARAMETER (C_{EXT} CABLE) AND (L_{EXT} CABLE) SPECIFIED ABOVE, BASED ON THE CABLE PROVIDED, SEE NOMENCLATURE ITEM "e" FOR THE DEVICE'S CABLE TYPE.

3. THE ASSOCIATED APPARATUS INSTALLATION INSTRUCTIONS MUST BE FOLLOWED WHEN INSTALLING THE EQUIPMENT.

4. WARNING - ALL FIELD WIRING SHALL BE SUITABLE FOR AN AMBIENT TEMPERATURE RANGE OF -20° TO 80°C.

5. THE CABLE USED IN THIS DEVICE HAS A VENT TUBE. THEREFORE THE CABLE ATTACHED TO THE PBLTX SHALL BE TERMINATED IN THE HAZARDOUS AREA.

6. NO REVISIONS TO THIS DRAWING WITHOUT PRIOR APPROVAL BY UL/DEWKO.

7. TRANSDUCER MUST BE INSTALLED IN ACCORDANCE TO IEC/EN 60079-14 OR ANY LOCAL INSTALLATION CODES/REQUIREMENTS.

ATEX CLASSIFICATION: I G Ex ia IIC T4 Ga (-20°C ≤ Tamb ≤ 80°C (ETFE CABLE)) (-20°C ≤ Tamb ≤ 65°C (POLYURETHANE CABLE))
I D Ex ia IIC T1.35°C Da (-20°C ≤ Tamb ≤ 80°C (ETFE CABLE)) (-20°C ≤ Tamb ≤ 65°C (POLYURETHANE CABLE))

IECEx CLASSIFICATION: Ex ia IIC T4 Ga (-20°C ≤ Tamb ≤ 80°C (ETFE CABLE)) (-20°C ≤ Tamb ≤ 65°C (POLYURETHANE CABLE))
Ex ia IIC T1.35°C Da (-20°C ≤ Tamb ≤ 80°C (ETFE CABLE)) (-20°C ≤ Tamb ≤ 65°C (POLYURETHANE CABLE))

ATEX STANDARDS: EN 60079-0:2012(A11:2013)
EN 60079-11:2012

IEC STANDARDS: IEC 60079-0:2011 6TH ED.
IEC 60079-11:2011 6TH ED.

PBLTX-3000-0000-0000-0000-ATEX-1
| BLANK(STANDARD) OR 2YR(2 YEAR WARRANTY) WARRANTY TYPE
| ATEX (ATEX/IEC/EX COMPLIANT) CONFIGURATION
| BLANK(ETFE CABLE) OR PU(POLYURETHANE CABLE) CABLE TYPE
| BLANK(FEET) OR (METERS) CABLE UNITS
| ONE TO THREE DIGIT NUMERIC CHARACTER
| 1 TO 470(FEET) OR 1 TO 143(METERS) FOR POLYURETHANE CABLE.
| 1 TO 275(FEET) OR 1 TO 84(METERS) FOR ETFE CABLE CABLE LENGTH
| BLANK(PS) OR (METERS) RANGE UNITS
| ONE TO FIVE DIGIT NUMERIC CHARACTER,
| 5 TO 145(PS)
| 3.5 TO 100 METERS OF WC SENSOR RANGE

ZONE AND DIVISION ENTRY PARAMETERS ARE SHOWN AS: DIVISION (ZONE)

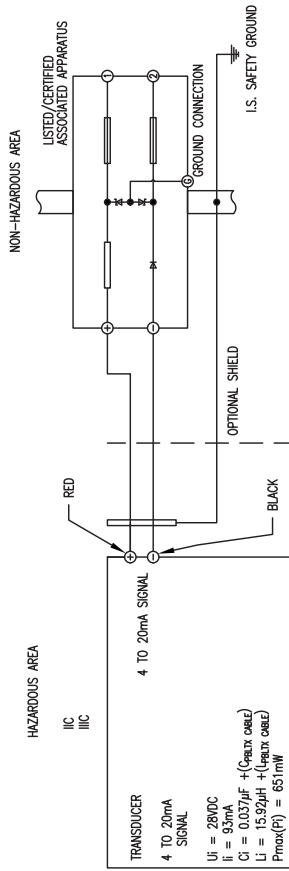

ASSOCIATED APPARATUS

- Voc (Vo) ≤ 28V
- Isc (Io) ≤ 93mA
- Pa (Po) ≤ 0.651W
- Ca (Co) ≥ 0.037uF + (Cext cable) + (Cable)
- La (Lo) ≥ 15.92uH + (Lext cable) + (Cable)

⊕ = CRITICAL DIMENSION
SIZES AND TOLERANCES UNLESS NOTED:
ALL DECIMAL DIMENSIONS ± .003
ALL ANGLES ± 1°

MATERIAL		DATE	NAME
2	ADDED ATEX CONFIGURATION PER EDR #045704	JEO 12-10-18	PBLTX I.S. CONTROL DRAWING ATEX/IECEx
1	GENERAL REVISION AS REQUESTED BY UL PER EDR #4310	RBS 6-20-18	FINISH
0	INITIAL RELEASE NO-005145	AMS 02-28-18	
	CHANGES	BY/DATE	LR
NO.			
ZONE AND DIVISION ENTRY PARAMETERS ARE SHOWN AS: DIVISION (ZONE)		ACAD2002	
NOTICE: This drawing and the principles and elements of design embodied therein are the exclusive property of DWYER INSTRUMENTS, INC. and are not to be reproduced without the written consent of DWYER INSTRUMENTS, INC. and are not to be submitted to outside parties for manufacturing purposes.		FR. NO. 001833-47	

DWYER INSTRUMENTS, INC.
MICHIGAN CITY, INDIANA 46360 U.S.A.