

# Heavy Duty Pressure Transmitter



measuring  
•  
monitoring  
•  
analyzing

PAS



**HART**  
COMMUNICATION FOUNDATION

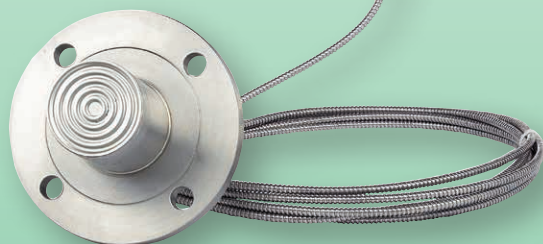

**ATEX**



- Span: -14.5 ... 21.7 PSIG up to 0 ... 8700 PSIG
- $t_{max}$ : 248 °F
- Process Connection: ½" NPT, or Various Diaphragm Seals on Request
- Material: 316L Stainless Steel
- Output: 4 ... 20 mA
- Sensor Input: Gauge or Absolute Pressure
- Self-Diagnostic Function: Sensor, Memory A/D Converter, Power etc.
- Digital Communication with HART® Protocol



KOBOLD companies worldwide:

AUSTRALIA, AUSTRIA, BELGIUM, BULGARIA, CANADA, CHINA, CZECHIA, FRANCE, GERMANY, GREAT BRITAIN, HUNGARY, INDIA, INDONESIA, ITALY, MALAYSIA, MEXICO, NETHERLANDS, PERU, POLAND, REPUBLIC OF KOREA, RUSSIA, SPAIN, SWITZERLAND, THAILAND, TUNISIA, TURKEY, USA, VIETNAM

KOBOLD Instruments, Inc.  
1801 Parkway View Drive  
Pittsburgh, PA 15205  
Main Office:  
1.412.788.2830  
1.412.788.4890  
info@koboldusa.com  
www.koboldusa.com



## Heavy Duty Pressure Transmitter Model PAS



### Description

The KOBOLD Pressure Transmitter model PAS is a microprocessor based high performance transmitter, which has a scalable pressure calibration and output signal. It automatically compensates for ambient temperature and process variables. Communication with the instrument and configuration of various parameters is possible via HART® protocol. All of the sensor's data is input, modified and stored via EEPROM.

### Features

#### Superior Performance

- High Reference Accuracy:  $\pm 0.075\%$  of Calibrated Span
- Long-term Stability
- High Rangeability (100:1)

### Flexibility

- Data configuration with HART® configurator
- Measurement of gauge or absolute pressure

### Reliability

- Continuous self-diagnostic function
- Automatic ambient temperature compensation
- EEPROM write-protection
- Fail-mode process function

### Transmitter Description

#### Electronics Module

The Electronics module consists of a circuit board sealed in an enclosure. There is an MCU module, an analog module, an LCD module, and a terminal module within the transmitter. The MCU module acquires the digital value from the analog module and applies correction coefficients selected from EEPROM. The output section of the MCU module converts the digital signal to a 4...20 mA output. The MCU module communicates with the HART®-based configurator or control system, such as DCS (Distributed Control System). The power section of the MCU module has a DC-to-DC power conversion circuit and an input/output isolation circuit. The LCD module plugs into the MCU module and displays the digital output in a user configured unit.

#### Sensor Inputs

The pressure transmitter model PAS is available as a piezo-resistive pressure transmitter which measures gauge pressure as well as absolute pressure. The sensor module converts the resistance into a digital value. The MCU module calculates the process pressure based on this digital value.

### Functional Block Diagram

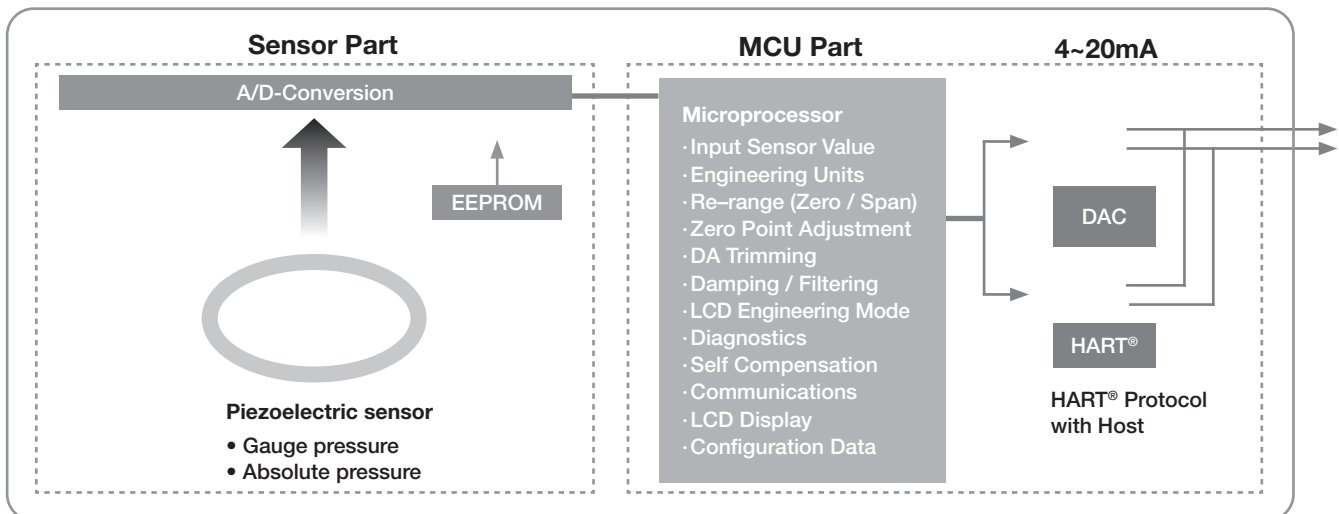

The sensor modules include the following features:

- The software of the transmitter compensates for thermal effects, improving performance.
- Precise Input Compensation during operation is achieved with temperature and pressure correction coefficients that are characterized over the range of the transmitter and stored in the sensor module's EEPROM memory.
- EEPROM stores sensor information and correction coefficients separately from the MCU module, allowing for easy repair, reconfiguration and replacement.

### Basic Setups

The following settings can be easily configured from any host that can support HART® protocol:

- Operational parameters
- 4 ... 20 mA (zero points/span)
- Engineering units
- Damping time: 0.25...60 sec.
- Tag: 8 alphanumeric characters
- Descriptor: 16 characters
- Message: 32 characters
- Date: day/month/year

### Calibration and Adjustment

- Lower/Upper range (zero/span)
- Sensor zero adjustment
- Zero point adjustment
- DAC output adjustment
- Transfer function
- Self-compensation

### Self-Diagnostics and Others

- CPU & Analog Module Fault Detection
- Communication error
- Fail-mode handling
- LCD indication
- Temperature measurement of sensor module

### Process Connection via Diaphragm Seals

For connecting the model PAS to different process connections, diverse diaphragm seal versions are necessary. They can be connected to the pressure transmitter directly or via a capillary tube. Depending on the application; different combinations of diaphragm seals, capillary tubes and fill fluids are possible. To clarify those possibilities, the special connections via diaphragm seals should be requested separately from the pressure transmitter.



### Technical Details

<b>Measuring Principle:</b>	Piezoresistive Sensor
<b>Measuring Span:</b>	-14.5...21.7 PSIG up to 0...8700 (Depending on instrument version), zero and span values can be set anywhere within the range limits. Span must be greater than or equal to the minimum span.
<b>Accuracy:</b>	±0.075% of span (0.1 URL ≤ span ≤ URL) ± [0.025+0.005x(URL/span)]% of span (0.01 URL ≤ span ≤ 0.1 URL)
<b>Process Temperature:</b>	-40...248 °F (Approval codes may effect limits. Max. ambient temperature at LCD = 176 °F.)
<b>Ambient Temperature:</b>	-22...176 °F
<b>Ambient Temp. Effect:</b>	±(0.019% URL + 0.125% span)/28 °C
<b>Storage Temperature:</b>	-40...185 °F (Non-condensing)
<b>Humidity Limit:</b>	5 %...98 % RH
<b>Power Supply Effect:</b>	±0.005% of span/V
<b>Stability:</b>	±[0.125% URL for 36 months]



Technical Details Cont

Pressure Limits (with Silicone Oil)

(Valid for stand-alone unit only, without assembled diaphragm seals.)

Model G -14.5...43.5 PSIG (for Range 3)
-14.5...435 PSIG (for Range 4)
0...1552.5 PSIG (for Range 5)
0...5800 PSIG (for Range 6)
0...10875 PSIG (for Range 7)

Model A 0...72.5 PSIG (for Range 4)
0...435 PSIG (for Range 5)
0...754 PSIG (for Range 6)

Burst Pressure

Model G 87 PSIG (for Range 3)
580 PSIG (for Range 4)
2030 PSIG (for Range 5)
7250 PSIG (for Range 6)
11600 PSIG (for Range 7)

Model A 145 PSIG (for Range 4)
580 PSIG (for Range 5)
1015 PSIG (for Range 6)

Wetted Materials

Isolating Diaphragms: 316L Stainless Steel

Connection Thread: 316 Stainless Steel

Non-wetted Materials

Fill Fluid: Silicone oil

Electronics Housing: Aluminum, flameproof (Ex d) and waterproof (IP 67), 316 L SS (option)

Cover O-ring: NBR

Paint: Epoxy-polyester or polyurethane

Mounting Bracket: 2-inch pipe, 304 SS, painted carbon steel with 304 SS U-bolt

Nameplate: 304 Stainless steel

Process Connections: 1/2" NPT female

Mounting Position: Upright

Display: 5 Digit LCD

Power Supply: 12...45 VDC -operation
17.5...45 VDC -HART® communications

Maximum Load: 250 Ohm at 17.5 VDC
550 Ohm at 24 VDC
Max. loop resistance = (U - 12 VDC) / 0.022 A

Electrical Connection: 1/2" NPT conduit with M4 screw terminals, G 1/2 conduit with M4 screw terminals

Output: Two wire 4...20 mA, user-configurable for linear output, digital process value superimposed on 4...20 mA signal, available to any host that conforms to the HART® protocol

Update Time: 0.12 seconds

Turn-On Time: 3 seconds

Protection: IP67 for standard (code S)

Weight: 3.8 lbs (excluding options)
6.3 lbs (st. steel housing option)

Failure Mode: Fail high: current >= 21.1 mA
Fail low: current <= 3.78 mA

EMC Conformity Standards:

EMI (emission) - EN 50081-2:1993
EMS (immunity) - EN 50082-2:1995

ATEX Approval (Option):

Ex II 2G Exd IIC T6...T4
Ex II 1G or 2G Ex ia IIC T5 or T4 Ga or Gb

Technical Data for Version with 50 mm Extended Diaphragm

(Model PAS-P, Engineered for the Paper/Pulp Industry)

Application: Level and gauge pressure measurement

Accuracy: +/- 0.2% of calibrated span @ 68 °F

Long Term Stability: Application dependent, typically +/- 0.125% of URL / 1 year

Process Temperature: 68...95 °F

Ambient Temperature: 68...95 °F

Materials:

O-ring: FKM

Extended Sleeve: 304 Stainless Steel

Process Connection: 316-Ti / 316 Stainless Steel

Other Specifications: Same as Standard model



**Order Details** (Example: **PAS- G EE 3 S 4 N S0 0**):

Model	Version	Material Diaphragm/Other	Measuring Range	Measuring Span
PAS-	..G.. = Gauge Pressure  ..A.. = Absolute Pressure	..EE.. = 316L st. st./316 st. steel	for PAS-G	
			..3.. = -14.5...21.7 PSIG ..4.. = -14.5...217 PSIG ..5.. = 0...725 PSIG ..6.. = 0...3625 PSIG ..7.. = 0...8700 PSIG	6 W.C....21.7 PSIG 60 W.C....217 PSIG 200 W.C....725 PSIG 36.3 PSIG...3625 PSIG 87 PSIG...8700 PSIG
			for PAS-A	
			..4.. = 0...36 PSIA ..5.. = 0...217 PSIA ..6.. = 0...362 PSIA	10 W.C....36 PSIA 60 W.C....217 PSIA 100 W.C....362 PSIA

**Order Details Continued:**

Fill Liquid	Process Connection	Electrical Connection	Approvals	Options
..S.. = silicone	..4.. = 1/2" NPT female	..N.. = 1/2" NPT epoxy-polyester painted aluminum  ..G.. = G 1/2 epoxy-polyester painted aluminum	..S0.. = standard (waterproof IP 67)  ..F0.. = ATEX, flameproof, Ex d  ..E0.. = ATEX, Intrinsically Safe, Ex i	..0 = without  ..E = oil free finish  ..M = housing in stainless steel  ..N <sup>1)</sup> = mounting of PAS onto diaphragm seal

<sup>1)</sup> Diaphragm seal model and application data to be clearly specified. If ordering the PAS with a DRM, the application guide posted on the product page online must be completed. For summary of diaphragm seal models and possible ranges, see page 9 onwards. For dimensional details see DRM data sheet.

**Order Details Mounting Brackets:**

Description	Order Number
Angle type bracket for PAD/PAS vertical pipe mounting for PAS vertical pipe mounting for PAD incl. U-Clamp for 2" pipe mounting bracket and 2 x mounting nuts/ washers incl. 4 x mounting screws for PAS incl. 4 x mounting screws for PAD	<b>ZUB-PAD/PAS-K</b>
Flat type bracket for PAD/PAS horizontal pipe mounting for PAS vertical pipe mounting for PAD incl. U-Clamp for 2" pipe mounting bracket and mounting nuts/ washers incl. 4 x mounting bolts and washers for PAS incl. 4 x mounting bolts for PAD	<b>ZUB-PAD/PAS-L</b>

**Order Details Manifold Valve:**

Description	Order Number
2-way Manifold Valve, Direct Mount, Machined	<b>V-2003CDADABAA</b>



## Heavy Duty Pressure Transmitter Model PAS

Order Details for PAS-..P Extended Diaphragm Version for Paper/Pulp Industries (Example: PAS-P ES 3 S A N S 0 0)

Model	Material	Measuring Ranges		
	Diaphragm/Other	Code	Measuring Range	Measuring Span
PAS-P..	..ES.. = 316 SS / 304 SS, 316L SS, 316-Ti SS	..3..	-10,000 mm H <sub>2</sub> O...15,000 mm H <sub>2</sub> O	300 mm H <sub>2</sub> O...15,000 mm H <sub>2</sub> O
		..4..	-10,000 mm H <sub>2</sub> O...150 m H <sub>2</sub> O	1,500 mm H <sub>2</sub> O...150 m H <sub>2</sub> O

Order Details Continued

Filling Liquid	Process Connection	Electrical Connection	Approval	Manifold Valve	Options
..S.. = Silicone	..N.. = 1" Class 150 RF ..P.. = 1-1/4" Class 150 RF ..Q.. = 1-1/2" Class 150 RF ..R.. = 2" Class 150 RF ..S.. = 2-1/2" Class 150 RF ..T.. = 3" Class 150 RF ..U.. = 4" Class 150 RF ..V.. = 5" Class 150 RF ..W.. = 6" Class 150 RF	..N.. = 1/2" NPT epoxy-polyester painted aluminum  ..G.. = 1/2" epoxy-polyester painted aluminum	..S.. = without, standard, (waterproof IP 67)	..0.. = without	..0 = without

**Dimensions**

**Standard Model**

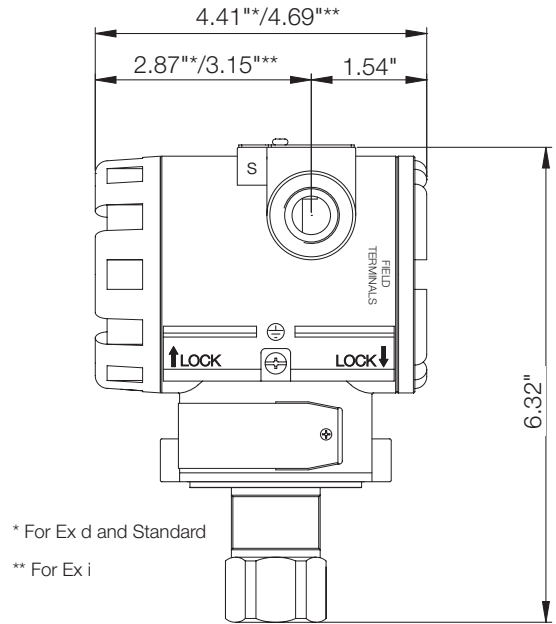
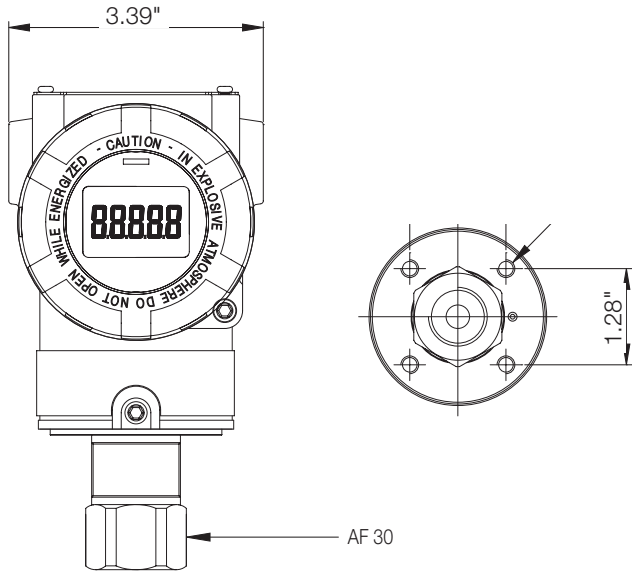

**2-way Manifold Valve: (Direct Mount, Machined) V-2003CDADABAA (PTFE Packing)**

(Inlet: 1/2" NPT Female/Outlet: 1/2" NPT Male)

**Technical Details**

- Material:** AISI 316L
- Pressure Rating:** 6000 psi
- Temperature Range:** -99...410 °F (PTFE Packing), Standard  
-65...950 °F (GRAPHOIL Packing), On Request
- Weight:** 1.94 lbs

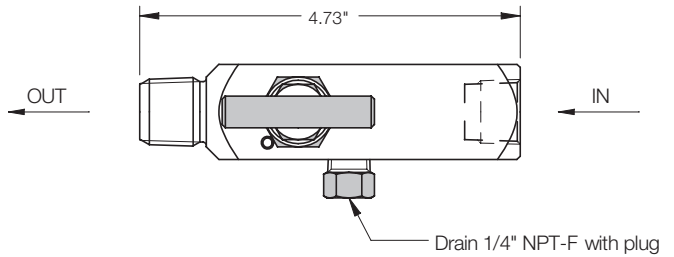
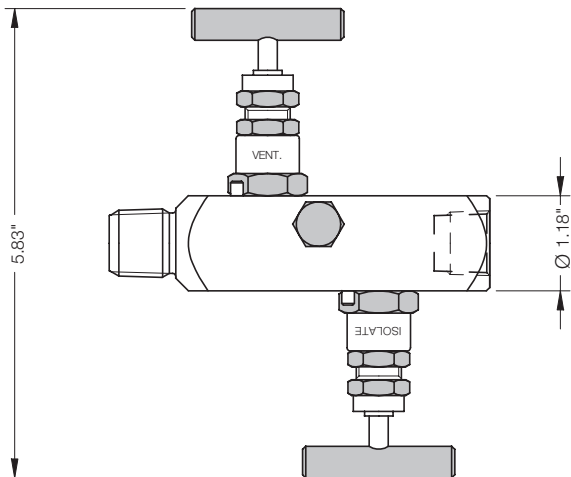
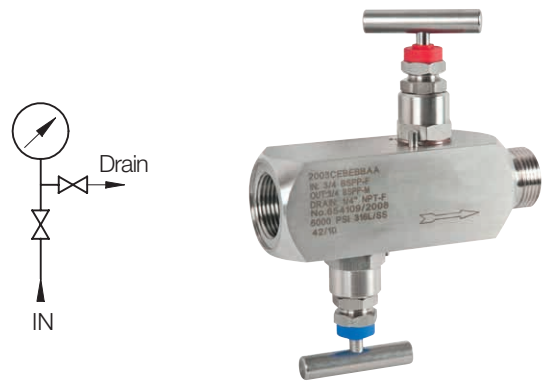

**Included Accessories: Plug**

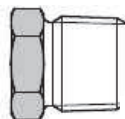

No responsibility taken for errors; subject to change without prior notice.



## Heavy Duty Pressure Transmitter Model PAS

### Dimensions

Model: PAS-P with Extended Diaphragm 50 mm

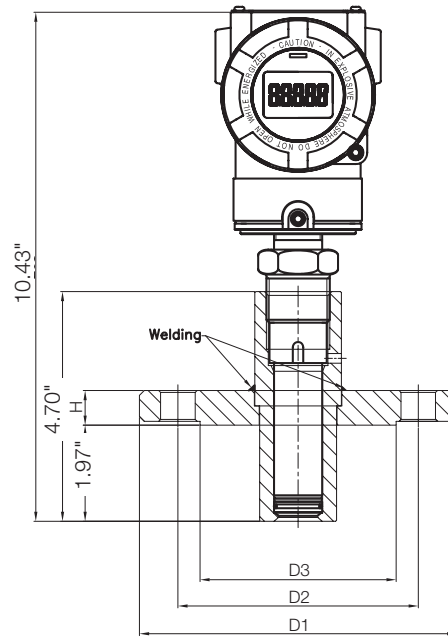

### Connection ASME B16.5 RF Class 150

Code	inches	D1	D2	D3	H
N	1	4.25"	3.12"	2.00"	0.56"
P	1-¼	4.62"	3.50"	2.50"	0.62"
Q	1-½	5.00"	3.88"	2.88"	0.69"
R	2	6.00"	4.75"	3.62"	0.75"
S	2-½	7.00"	5.50"	4.12"	0.88"
T	3	7.50"	6.00"	5.00"	0.94"
U	4	9.00"	7.50"	6.19"	0.94"
V	5	10.00"	8.50"	7.31"	0.94"
W	6	11.00"	9.50"	8.50"	1.00"



**Example of PAS Directly Assembled with Diaphragm Seal**  
(for Dimensional Details, see DRM Datasheet)

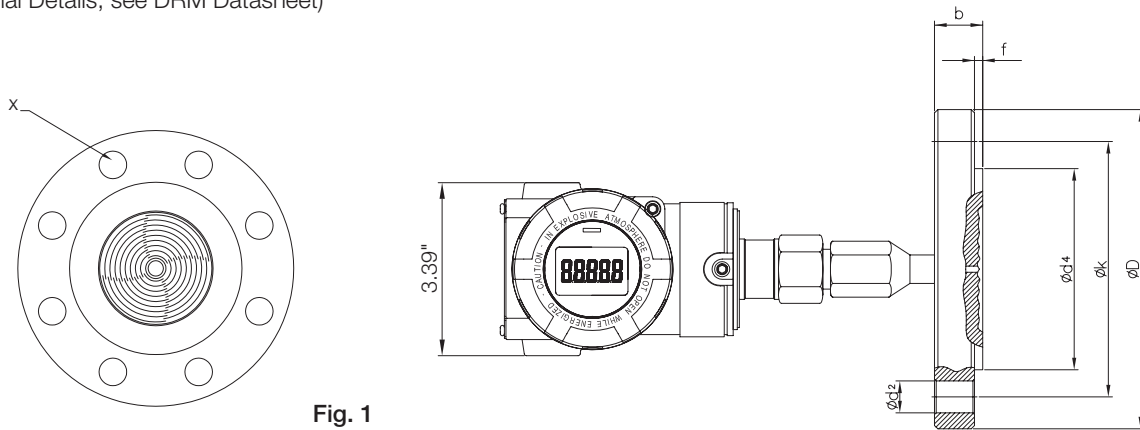

Fig. 1

**Example of PAS Remotely Assembled with Diaphragm Seal and Capillary**  
(for Dimensional Details, see DRM Datasheet)

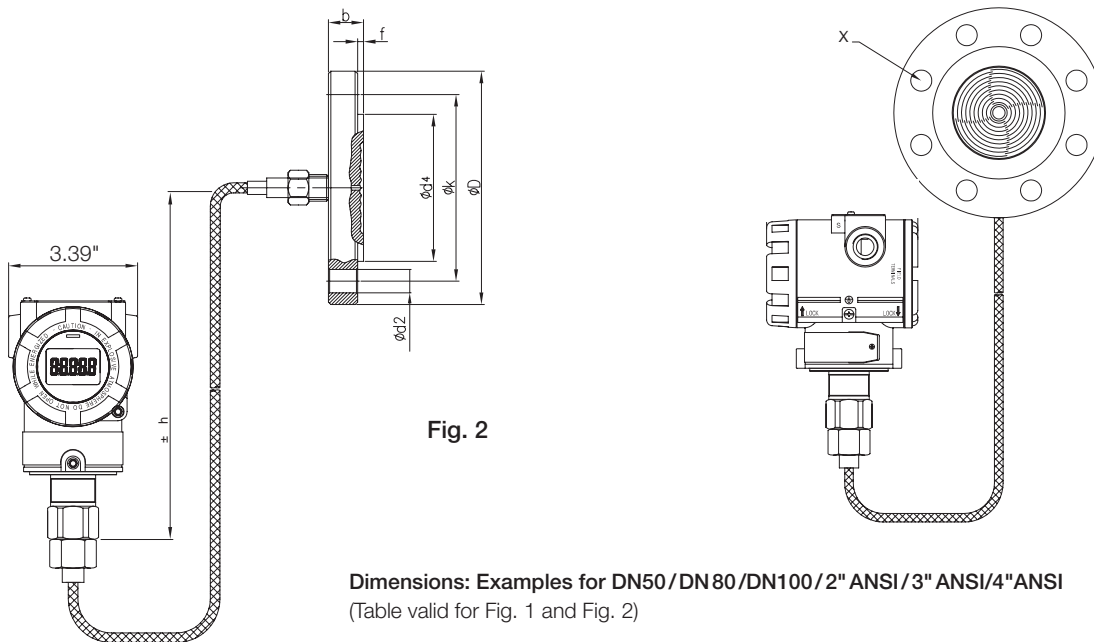

Fig. 2

**Dimensions: Examples for DN50/DN80/DN100/2" ANSI/3" ANSI/4" ANSI**  
(Table valid for Fig. 1 and Fig. 2)

Flange Type	D	k	d <sup>2</sup>	b	f	d <sup>4</sup>	X
DN50 PN16	6.50"	4.92"	0.71"	0.71"	0.08"	4.02"	0.16"
DN50 PN40	6.50"	4.92"	0.71"	0.79"	0.08"		0.16"
2" ANSI Cl. 150	6.00"	4.75"	0.75"	0.75"	0.08"	3.62"	0.16"
2" ANSI Cl. 300	6.50"	5.00"	0.75"	0.88"	0.08"		0.31"
DN80 PN16	7.87"	6.30"	0.71"	0.79"	0.08"	5.43"	0.31"
DN80 PN40	7.87"	6.30"	0.71"	0.94"	0.08"		0.31"
3" ANSI Cl. 150	7.50"	6.00"	0.75"	0.94"	0.06"	5.00"	0.16"
3" ANSI Cl. 300	8.25"	6.63"	0.87"	1.12"	0.06"		0.31"
DN100 PN16	8.66"	7.09"	0.71"	0.79"	0.08"	5.87"	0.31"
DN100 PN40	9.25"	7.48"	0.87"	0.94"	0.08"		0.31"
4" ANSI Cl. 150	9.00"	7.50"	0.75"	0.94"	0.06"	6.19"	0.31"
4" ANSI Cl. 300	10.00"	7.87"	0.87"	1.26"	0.06"		0.31"



Example of PAS Remotely Assembled with Extended Diaphragm Seal and Capillary  
 (for Dimensional Details, see DRM Datasheet)

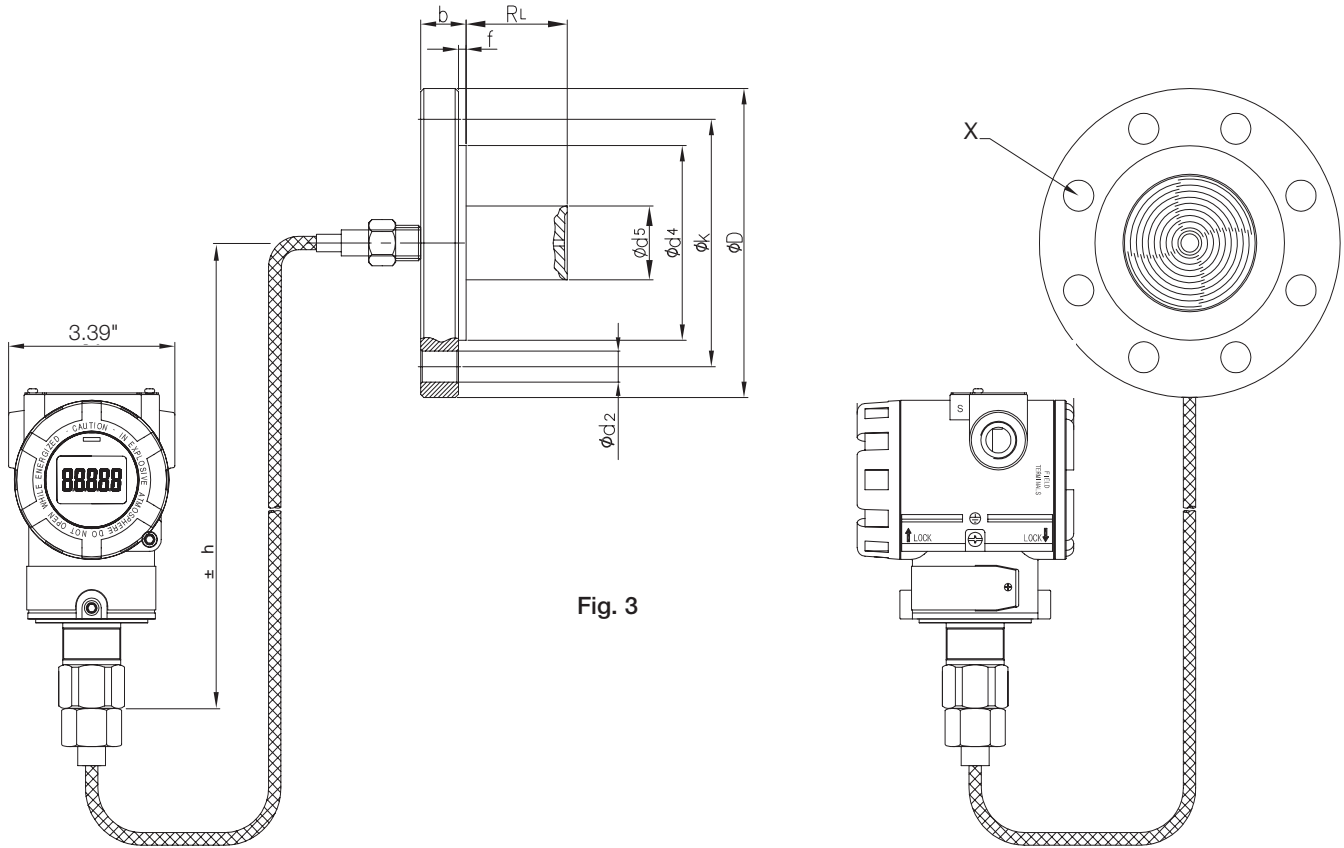

Fig. 3

Dimensions: Examples for DN50/DN80/DN100/2" ANSI/3" ANSI/4" ANSI

Flange Type	D	k	d <sup>2</sup>	b	f	d <sup>4</sup>	X	d <sup>5</sup>	R <sub>L</sub>
DN50 PN16	6.50"	4.92"	0.71"	0.71"	0.08"	4.02"	0.16"	1.89"	50 mm (2")/ 100 mm (4")/ 150 mm (6")/ 200 mm (8")/ (customer specified)
DN50 PN40	6.50"	4.92"	0.71"	0.79"	0.08"	4.02"	0.16"	1.89"	
2" ANSI Cl. 150	6.00"	4.75"	0.75"	0.75"	0.08"	3.62"	0.16"	1.89"	
2" ANSI Cl. 300	6.50"	5.00"	0.75"	0.88"	0.08"	3.62"	0.31"	1.89"	
DN80 PN16	7.87"	6.30"	0.71"	0.79"	0.08"	5.43"	0.31"	2.99"	
DN80 PN40	7.87"	6.30"	0.71"	0.94"	0.08"	5.43"	0.31"	2.99"	
3" ANSI Cl. 150	7.50"	6.00"	0.75"	0.94"	0.06"	5.00"	0.16"	2.99"	
3" ANSI Cl. 300	8.25"	6.63"	0.87"	1.12"	0.06"	5.00"	0.31"	2.99"	
DN100 PN16	8.66"	7.09"	0.71"	0.79"	0.08"	5.87"	0.31"	3.50"	
DN100 PN40	9.25"	7.48"	0.87"	0.94"	0.08"	5.87"	0.31"	3.50"	
4" ANSI Cl. 150	9.00"	7.50"	0.75"	0.94"	0.06"	6.19"	0.31"	3.50"	
4" ANSI Cl. 300	10.00"	7.87"	0.87"	1.26"	0.06"	6.19"	0.31"	3.50"	

**Diaphragm Seal Models (Direct or Remote Assembly)**

(Standard device without additional options (e.g. coatings, special materials etc.).

For dimensions/technical data, see DRM data sheet. Accuracy: 0.075% of calibrated span + influence of seal).

Over and under ranges of the min./max. span may be possible, but must be verified by KOBOLD for each application.

The indicated min./max. spans do not consider any coating of the diaphragm seals. For additional information contact KOBOLD.

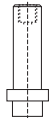
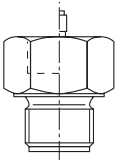
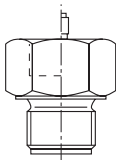
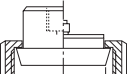





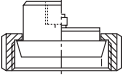

Model DRM	Size Code	Size	Note	Ø Diaphragm	Max. Media Temperature	Min. Span (PSIG)	Max. Span (PSIG)
<b>DRM-189</b> 	<b>F23</b>	Ø 18	For homogenizing machines, direct	Ø 18	248 °F	0...58	14500
<b>DRM-600</b> 	<b>R15</b>	G ½	Fixed male thread, direct	Ø 18	212 °F	0...58*	14500
	<b>R20</b>	G ¾		Ø 23.8		0...23.2*	14500
	<b>R25</b>	G 1		Ø 29.5		0...14.5	8700
	<b>R32</b>	G 1 ¼		Ø 38		0...8.7	8700
	<b>R40</b>	G 1 ½		Ø 40		0...8.7	8700
	<b>N15</b>	½" NPT		Ø 18		0...58*	14500
	<b>N20</b>	¾" NPT		Ø 18		0...58*	14500
	<b>N25</b>	1" NPT		Ø 23.8		0...23.2	8700
	<b>N32</b>	1 ¼" NPT		Ø 34.5		0...14.5	8700
	<b>M20</b>	M20 x 1.5		Ø 18		0...58	8700
	<b>M48</b>	M 48 x 3		Ø 40		0...8.7	8700
<b>DRM-601</b> 	<b>R15</b>	G ½	Fixed male thread with capillary	Ø 18	392 °F	0...58*	14500
	<b>R20</b>	G ¾		Ø 23.8		0...23.2*	14500
	<b>R25</b>	G 1		Ø 29.5		0...14.5	8700
	<b>R32</b>	G 1 ¼		Ø 38		0...8.7	8700
	<b>R40</b>	G 1 ½		Ø 40		0...8.7	8700
	<b>N15</b>	½" NPT		Ø 18		0...58*	14500
	<b>N20</b>	¾" NPT		Ø 18		0...58*	14500
	<b>N25</b>	1" NPT		Ø 23.8		0...23.2	8700
	<b>N32</b>	1 ¼" NPT		Ø 34.5		0...14.5	8700
	<b>M20</b>	M20 x 1,5		Ø 18		0...58	8700
	<b>M48</b>	M 48 x 3		Ø 40		0...8.7	8700
<b>DRM-602</b> DIN 11851 	<b>R20</b>	DN 20	Dairy connection, direct	Ø 18	212 °F	0...58	580
	<b>R25</b>	DN 25		Ø 23.8		0...23.2	580
	<b>R32</b>	DN 32		Ø 29.5		0...14.5	580
	<b>R40</b>	DN 40		Ø 38		0...8.7	580
	<b>R50</b>	DN 50		Ø 45.5		0...5.8	362.5
	<b>R65</b>	DN 65		Ø 64		0...3.6	362.5
	<b>R80</b>	DN 80		Ø 64		0...3.6	362.5
	<b>R1H</b>	DN 100		Ø 64		0...3.6	362.5

\* Consult Factory for Minimum Span per Customer Application

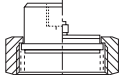



## Heavy Duty Pressure Transmitter Model PAS

### Diaphragm Seal Models (Direct or Remote Assembly)

Model DRM	Size Code	Size	Note	Ø Diaphragm	Max. Media Temperature	Min. Span (PSIG)	Max. Span (PSIG)
<b>DRM-603</b> DIN 11851 	R20	DN 20	Dairy connection, capillary	Ø 18	392 °F	0...58	580
	R25	DN 25		Ø 23.8		0...23.2	580
	R32	DN 32		Ø 29.5		0...14.5	580
	R40	DN 40		Ø 38		0...8.7	580
	R50	DN 50		Ø 45.5		0...5.8	362.5
	R65	DN 65		Ø 64		0...3.6	362.5
	R80	DN 80		Ø 64		0...3.6	362.5
R1H	DN 100	Ø 64	0...3.6	362.5			
<b>DRM-604</b> IDF 	R25	1"	IDF socket with union nut, direct	Ø 29.5	212 °F	0...23.2	580
	R40	1½"		Ø 42		0...14.5	580
	R50	2"		Ø 56		0...8.7	580
<b>DRM-605</b> IDF 	R25	1"	IDF socket with union nut, capillary	Ø 29.5	392 °F	0...14.5	580
	R40	1½"		Ø 42		0...8.7	580
	R50	2"		Ø 56		0...5.8	580
<b>DRM-606</b> 	R20	G¾	Capsule seal with rotatable male, capillary	short capsule	662 °F	0...87	8700
	R28	M28 x 1.5				0...87	8700
<b>DRM-607</b> 	R15	G½	Capsule seal with fixed male, direct	long capsule	212 °F	0...14.5	8700
	R20	G¾				0...14.5	8700
<b>DRM-607/1</b> 	R15	G¾	Capsule seal with fixed male, direct	long capsule	212 °F	0...14.5	8700
	R20	G1				0...14.5	8700
<b>DRM-608/1</b> 	R20	G¾	Capsule seal with union nut, capillary	long capsule	662 °F	0...14.5	8700
	R25	G1	Capsule seal with union nut, capillary	long capsule		0...14.5	8700
<b>DRM-610</b> SMS 	R40	1½"	SMS socket with union nut, direct	Ø 34.5	212 °F	0...14.5	580
	R50	2"		Ø 45.5		0...5.8	580

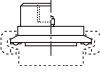
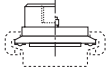
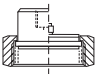
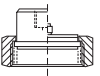
Diaphragm Seal Models (Direct or Remote Assembly)



Model DRM	Size Code	Size	Note	Ø Diaphragm	Max. Media Temperature	Min. Span (PSIG)	Max. Span (PSIG)
<b>DRM-611</b> SMS 	R40	1 ½"	SMS socket with union nut, capillary	Ø 34.5	392 °F	0...14.5	580
	R50	2"		Ø 45.5		0...5.8	580
<b>DRM-612</b> Clamp 	R25	1"	Tri-Clamp, direct	Ø 18	212 °F	0...58	232
	F40	1 ½"		Ø 35.5		0...14.5	232
	F50	2"		Ø 45.5		0...5.8	232
	R65	2 ½"		Ø 52		0...5.8	232
	R80	3"		Ø 64		0...3.6	145
<b>DRM-613</b> Clamp 	R25	1"	Tri-Clamp, capillary	Ø 18	392 °F	0...58	232
	F40	1 ½"		Ø 35.5		0...14.5	232
	F50	2"		Ø 45.5		0...5.8	232
	R65	2 ½"		Ø 52		0...5.8	232
	R80	3"		Ø 64		0...3.6	145
<b>DRM-614</b> APV-RJT 	R20	1"	Union-nut, direct	Ø 29.5	212 °F	0...23.2	1450
	R40	1 ½"		Ø 42.5		0...8.7	1450
	R50	2"		Ø 56		0...5.8	1450
<b>DRM-615</b> APV-RJT 	R20	1"	Union-nut, capillary	Ø 29.5	392 °F	0...23.2	1450
	R40	1 ½"		Ø 42.5		0...8.7	1450
	R50	2"		Ø 56		0...5.8	1450
<b>DRM-616</b> 	R45	M45 x 2	Union-nut, direct	Ø 23.8	212 °F	0...23.2	23200
<b>DRM-617</b> 	R45	M45 x 2	Union-nut, capillary	Ø 23.8	248 °F	0...23.2	23200

No responsibility taken for errors; subject to change without prior notice.



## Heavy Duty Pressure Transmitter Model PAS



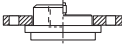
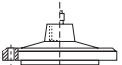
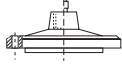
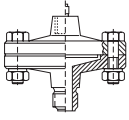
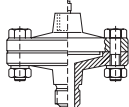

### Diaphragm Seal Models (Direct or Remote Assembly)

Model DRM	Size Code	Size	Note	Ø Diaphragm	Max. Media Temperature	Min. Span (PSIG)	Max. Span (PSIG)
 DRM-620	R20	G $\frac{3}{4}$	Union-nut, capillary	Ø 23.8	662 °F	0...23.2	8700
	DRM-620/1	R20	G $\frac{3}{4}$	Union-nut, capillary	Ø 23.8	662 °F	0...23.2
 DRM-621	F38	Ø 38 mm	Flange, direct	Ø 38	482 °F	0...5.8	580
	DRM-622	F48	Ø 48 mm	Flange, direct	Ø 48	212 °F	0...5.8
 DRM-622/1	F48 1	Ø 48 mm	Ø 48		0...5.8		580
	F48 2	Ø 48 mm	Ø 48		0...5.8		580
 DRM-622/1	F48	Ø 48 mm	Flange, capillary	Ø 48	392 °F	0...5.8	580
	F48 1	Ø 48 mm		Ø 48		0...5.8	580
	F48 2	Ø 48 mm		Ø 48		0...5.8	580
 DRM-624	F1H	Ø 100 mm	Flange, direct	Ø 63.5	212 °F	0...3.6	580
	F1H T	Ø 100 mm	Flange, direct			0...3.6	580
 DRM-624/1	F1H	Ø 100 mm	Flange, capillary		482 °F	0...3.6	580
 DRM-625	R15	G $\frac{1}{2}$	Fixed male, direct	Ø 63.5	212 °F	0...3.6	580
	N15	$\frac{1}{2}$ NPT				0...3.6	580
	I15	G $\frac{1}{2}$ IG				0...3.6	580
 DRM-625/1	R15	G $\frac{1}{2}$	Fixed male, capillary	Ø 63.5	482 °F	0...3.6	580
	N15	$\frac{1}{2}$ NPT				0...3.6	580
	I15	G $\frac{1}{2}$ IG				0...3.6	580

No responsibility taken for errors;  
subject to change without prior notice.

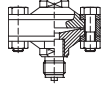
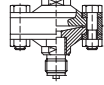
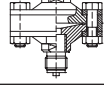
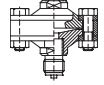
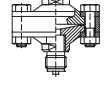
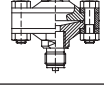

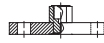
Diaphragm Seal Models (Direct or Remote Assembly)



Model DRM	Size Code	Size	Note	Ø Diaphragm	Max. Media Temperature	Min. Span (PSIG)	Max. Span (PSIG)
<b>DRM-626</b> PN25 	R08 A025	G ¼ male	Fixed male, direct	Ø 56	176 °F	0...5.8	362.5
	R08 I025	G ¼ female	Fixed female, direct	Ø 56		0...5.8	362.5
	R15 A025	G ½ male	Fixed male, direct	Ø 56		0...5.8	362.5
	R15 I025	G ½ female	Fixed female, direct	Ø 56		0...5.8	362.5
	N15 A025	½ NPT male	Fixed male, direct	Ø 56		0...5.8	362.5
<b>DRM-626</b> PN100 	R08 A100	G ¼ male	Fixed male, direct	Ø 56	176 °F	0...5.8	1450
	R08 I100	G ¼ female	Fixed female, direct	Ø 56		0...5.8	1450
	R15 A100	G ½ male	Fixed male, direct	Ø 56		0...5.8	1450
	R15 I100	G ½ female	Fixed female, direct	Ø 56		0...5.8	1450
	N15 A100	½ NPT male	Fixed male, direct	Ø 56		0...5.8	1450
<b>DRM-626</b> PN250 	R08 A250	G ¼ male	Fixed male, direct	Ø 56	176 °F	0...5.8	3625
	R08 I250	G ¼ female	Fixed female, direct	Ø 56		0...5.8	3625
	R15 A250	G ½ male	Fixed male, direct	Ø 56		0...5.8	3625
	R15 I250	G ½ female	Fixed female, direct	Ø 56		0...5.8	3625
	N15 A250	½ NPT male	Fixed male, direct	Ø 56		0...5.8	3625
<b>DRM-627</b> PN25 	R08 A025	G ¼ male	Fixed male, capillary	Ø 56	482 °F	0...5.8	362.5
	R08 I025	G ¼ female	Fixed female, capillary	Ø 56		0...5.8	362.5
	R15 A025	G ½ male	Fixed male, capillary	Ø 56		0...5.8	362.5
	R15 I025	G ½ female	Fixed female, capillary	Ø 56		0...5.8	362.5
	N15 A025	½ NPT male	Fixed male, capillary	Ø 56		0...5.8	362.5
<b>DRM-627</b> PN100 	R08 A100	G ¼ male	Fixed male, capillary	Ø 56	482 °F	0...5.8	1450
	R08 I100	G ¼ female	Fixed female, capillary	Ø 56		0...5.8	1450
	R15 A100	G ½ male	Fixed male, capillary	Ø 56		0...5.8	1450
	R15 I100	G ½ female	Fixed female, capillary	Ø 56		0...5.8	1450
	N15 A100	½ NPT male	Fixed male, capillary	Ø 56		0...5.8	1450
<b>DRM-627</b> PN250 	R08 A250	G ¼ male	Fixed male, capillary	Ø 56	482 °F	0...5.8	3625
	R08 I250	G ¼ female	Fixed female, capillary	Ø 56		0...5.8	3625
	R15 A250	G ½ male	Fixed male, capillary	Ø 56		0...5.8	3625
	R15 I250	G ½ female	Fixed female, capillary	Ø 56		0...5.8	3625
	N15 A250	½ NPT male	Fixed male, capillary	Ø 56		0...5.8	3625
<b>DRM-628</b> PN06 	F25P06	DN25	Flange to EN1092-1, direct	Ø 24	176 °F	0...23.2	87
	F32P06	DN32		Ø 30		0...23.2	87
	F40P06	DN40		Ø 38		0...8.7	87
	F50P06	DN50		Ø 48		0...5.8	87
	F65P06	DN65		Ø 64		0...3.6	87
	F80P06	DN80		Ø 64		0...3.6	87
	N1HP06	DN100		Ø 64		0...3.6	87
<b>DRM-628</b> PN16 	F25P16	DN25	Flange to EN1092-1, direct	Ø 24	176 °F	0...23.2	232
	F32P16	DN32		Ø 30		0...23.2	232
	F40P16	DN40		Ø 38		0...8.7	232
	F50P16	DN50		Ø 48		0...5.8	232
	F65P16	DN65		Ø 64		0...3.6	232
	F80P16	DN80		Ø 64		0...3.6	232
	N1HP16	DN100		Ø 64		0...3.6	232
<b>DRM-628</b> PN40 	F25P40	DN25	Flange to EN1092-1, direct	Ø 24	176 °F	0...23.2	580
	F32P40	DN32		Ø 30		0...23.2	580
	F40P40	DN40		Ø 38		0...8.7	580
	F50P40	DN50		Ø 48		0...5.8	580
	F65P40	DN65		Ø 64		0...3.6	580
	F80P40	DN80		Ø 64		0...3.6	580
	N1HP40	DN100		Ø 64		0...3.6	580

No responsibility taken for errors; subject to change without prior notice.



## Heavy Duty Pressure Transmitter Model PAS

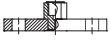
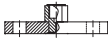

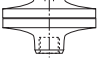
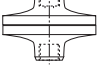
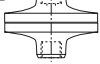
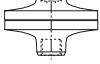
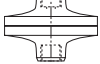
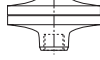

### Diaphragm Seal Models (Direct or Remote Assembly)

Model DRM	Size Code	Size	Note	Ø Diaphragm	Max. Media Temperature	Min. Span (PSIG)	Max. Span (PSIG)
<b>DRM-629</b> PN06 	<b>F25P06</b>	DN25	Flange to EN1092-1, capillary	Ø 24	482°F	0...23.2	87
	<b>F32P06</b>	DN32		Ø 30		0...23.2	87
	<b>F40P06</b>	DN40		Ø 38		0...8.7	87
	<b>F50P06</b>	DN50		Ø 48		0...5.8	87
	<b>F65P06</b>	DN65		Ø 64		0...3.6	87
	<b>F80P06</b>	DN80		Ø 64		0...3.6	87
	<b>F1HP06</b>	DN100		Ø 64		0...3.6	87
<b>DRM-629</b> PN16 	<b>F25P16</b>	DN25	Flange to EN1092-1, capillary	Ø 24	482°F	0...23.2	232
	<b>F32P16</b>	DN32		Ø 30		0...23.2	232
	<b>F40P16</b>	DN40		Ø 38		0...8.7	232
	<b>F50P16</b>	DN50		Ø 48		0...5.8	232
	<b>F65P16</b>	DN65		Ø 64		0...3.6	232
	<b>F80P16</b>	DN80		Ø 64		0...3.6	232
	<b>F1HP16</b>	DN100		Ø 64		0...3.6	232
<b>DRM-629</b> PN40 	<b>F25P40</b>	DN25	Flange to EN1092-1, capillary	Ø 24	482°F	0...23.2	580
	<b>F32P40</b>	DN32		Ø 30		0...23.2	580
	<b>F40P40</b>	DN40		Ø 38		0...8.7	580
	<b>F50P40</b>	DN50		Ø 48		0...5.8	580
	<b>F65P40</b>	DN65		Ø 64		0...3.6	580
	<b>F80P40</b>	DN80		Ø 64		0...3.6	580
	<b>F1HP40</b>	DN100		Ø 64		0...3.6	580
<b>DRM-630</b> PVC 	<b>R08</b>	G ¼ female	Fixed female, direct	Ø 64	104°F	0...3.6	145
	<b>R15</b>	G ½ female		Ø 64		0...3.6	145
	<b>N15</b>	½ NPT female		Ø 64		0...3.6	145
<b>DRM-630/1</b> PVC 	<b>R08</b>	G ¼ female	Fixed female, capillary	Ø 64	104°F	0...3.6	145
	<b>R15</b>	G ½ female		Ø 64		0...3.6	145
	<b>N15</b>	½ NPT female		Ø 64		0...3.6	145
<b>DRM-631</b> PP 	<b>R08</b>	G ¼ female	Fixed female, direct	Ø 64	104°F	0...3.6	145
	<b>R15</b>	G ½ female		Ø 64		0...3.6	145
	<b>N15</b>	½ NPT female		Ø 64		0...3.6	145
<b>DRM-631/1</b> PP 	<b>R08</b>	G ¼ female	Fixed female, capillary	Ø 64	104°F	0...3.6	145
	<b>R15</b>	G ½ female		Ø 64		0...3.6	145
	<b>N15</b>	½ NPT female		Ø 64		0...3.6	145
<b>DRM-632</b> PVDF 	<b>R08</b>	G ¼ female	Fixed female, direct	Ø 64	122°F	0...3.6	232
	<b>R15</b>	G ½ female		Ø 64		0...3.6	232
	<b>N15</b>	½ NPT female		Ø 64		0...3.6	232
<b>DRM-632/1</b> PVDF 	<b>R08</b>	G ¼ female	Fixed female, capillary	Ø 64	122°F	0...3.6	232
	<b>R15</b>	G ½ female		Ø 64		0...3.6	232
	<b>N15</b>	½ NPT female		Ø 64		0...3.6	232



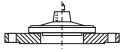
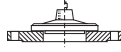

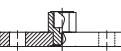
Diaphragm Seal Models (Direct or Remote Assembly)

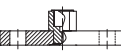





Model DRM	Size Code	Size	Note	Ø Diaphragm	Max. Media Temperature	Min. Span (PSIG)	Max. Span (PSIG)
 DRM-633	F50	DN 50	Flange to DIN2527 Form C, direct	Ø 64	212 °F	0...3.6	580
	F1H	DN 100		Ø 64		0...3.6	580
 DRM-633/1	F50	DN 50	Flange to DIN2527 Form C, capillary	Ø 64	482 °F	0...3.6	580
	F1H	DN 100		Ø 64		0...3.6	580
 DRM-634 150 lbs	A25P150	1"	Flange to ASME B16.5, direct	Ø 30	176 °F	0...23.2	145
	A32P150	1¼"		Ø 38		0...8.7	145
	A40P150	1½"		Ø 38		0...8.7	145
	A50P150	2"		Ø 48		0...5.8	145
	A65P150	2½"		Ø 48		0...5.8	145
	A80P150	3"		Ø 64		0...3.6	145
	A90P150	3½"		Ø 64		0...3.6	145
	A1HP150	4"		Ø 64		0...3.6	145
 DRM-634 300 lbs	A25P300	1"	Flange to ASME B16.5, direct	Ø 30	176 °F	0...23.2	290
	A32P300	1¼"		Ø 38		0...8.7	290
	A40P300	1½"		Ø 38		0...8.7	290
	A50P300	2"		Ø 48		0...5.8	290
	A65P300	2½"		Ø 48		0...5.8	290
	A80P300	3"		Ø 64		0...3.6	290
	A90P300	3½"		Ø 64		0...3.6	290
	A1HP300	4"		Ø 64		0...3.6	290
 DRM-634 600 lbs	A25P600	1"	Flange to ASME B16.5, direct	Ø 30	176 °F	0...23.2	580
	A32P600	1¼"		Ø 38		0...8.7	580
	A40P600	1½"		Ø 38		0...8.7	580
	A50P600	2"		Ø 48		0...5.8	580
	A65P600	2½"		Ø 48		0...5.8	580
	A80P600	3"		Ø 64		0...3.6	580
	A90P600	3½"		Ø 64		0...3.6	580
	A1HP600	4"		Ø 64		0...3.6	580
 DRM-634 1500 lbs	A25P1K5	1"	Flange to ASME B16.5, direct	Ø 30	176 °F	0...23.2	1450
	A32P1K5	1¼"		Ø 38		0...8.7	1450
	A40P1K5	1½"		Ø 38		0...8.7	1450
	A50P1K5	2"		Ø 48		0...5.8	1450
	A65P1K5	2½"		Ø 48		0...5.8	1450
	A80P1K5	3"		Ø 64		0...3.6	1450
	A90P1K5	3½"		Ø 64		0...3.6	1450
	A1HP1K5	4"		Ø 64		0...3.6	1450
 DRM-635 150 lbs	A25P150	1"	Flange to ASME B16.5, capillary	Ø 30	482 °F	0...23.2	145
	A32P150	1¼"		Ø 38		0...8.7	145
	A40P150	1½"		Ø 38		0...8.7	145
	A50P150	2"		Ø 48		0...5.8	145
	A65P150	2½"		Ø 48		0...5.8	145
	A80P150	3"		Ø 64		0...3.6	145
	A90P150	3½"		Ø 64		0...3.6	145
	A1HP150	4"		Ø 64		0...3.6	145

No responsibility taken for errors; subject to change without prior notice.



## Heavy Duty Pressure Transmitter Model PAS

### Diaphragm Seal Models (Direct or Remote Assembly)

Model DRM	Size Code	Size	Note	Ø Diaphragm	Max. Media Temperature	Min. Span (PSIG)	Max. Span (PSIG)
<b>DRM-635</b> 300 lbs 	A25P300	1"	Flange to ASME B16.5, capillary	Ø 30	482 °F	0...23.2	290
	A32P300	1¼"		Ø 38		0...8.7	290
	A40P300	1½"		Ø 38		0...8.7	290
	A50P300	2"		Ø 48		0...5.8	290
	A65P300	2½"		Ø 48		0...5.8	290
	A80P300	3"		Ø 64		0...3.6	290
	A90P300	3½"		Ø 64		0...3.6	290
	A1HP300	4"		Ø 64		0...3.6	290
<b>DRM-635</b> 600 lbs 	A25P600	1"	Flange to ASME B16.5, capillary	Ø 30	482 °F	0...23.2	580
	A32P600	1¼"		Ø 38		0...8.7	580
	A40P600	1½"		Ø 38		0...8.7	580
	A50P600	2"		Ø 48		0...5.8	580
	A65P600	2½"		Ø 48		0...5.8	580
	A80P600	3"		Ø 64		0...3.6	580
	A90P600	3½"		Ø 64		0...3.6	580
	A1HP600	4"		Ø 64		0...3.6	580
<b>DRM-635</b> 1500 lbs 	A25P1K5	1"	Flange to ASME B16.5, capillary	Ø 30	482 °F	0...23.2	1450
	A32P1K5	1¼"		Ø 38		0...8.7	1450
	A40P1K5	1½"		Ø 38		0...8.7	1450
	A50P1K5	2"		Ø 48		0...5.8	1450
	A65P1K5	2½"		Ø 48		0...5.8	1450
	A80P1K5	3"		Ø 64		0...3.6	1450
	A90P1K5	3½"		Ø 64		0...3.6	1450
	A1HP1K5	4"		Ø 64		0...3.6	1450
<b>DRM-637</b> PN 06 	F25P06	DN25	Flange to EN1092-1, direct	Ø 24	176 °F	0...23.2	87
	F32P06	DN32		Ø 30		0...23.2	87
	F40P06	DN40		Ø 38		0...14.5	87
	F50P06	DN50		Ø 48		0...8.7	87
	F65P06	DN65		Ø 64		0...3.6	87
	F80P06	DN80		Ø 64		0...3.6	87
	N1HP06	DN100		Ø 64		0...3.6	87
<b>DRM-637</b> PN 16 	F25P16	DN25	Flange to EN1092-1, direct	Ø 24	176 °F	0...23.2	232
	F32P16	DN32		Ø 30		0...23.2	232
	F40P16	DN40		Ø 38		0...14.5	232
	F50P16	DN50		Ø 48		0...8.7	232
	F65P16	DN65		Ø 64		0...3.6	232
	F80P16	DN80		Ø 64		0...3.6	232
	N1HP16	DN100		Ø 64		0...3.6	232
<b>DRM-637</b> PN 40 	F25P40	DN25	Flange to EN1092-1, direct	Ø 24	176 °F	0...23.2	580
	F32P40	DN32		Ø 30		0...23.2	580
	F40P40	DN40		Ø 38		0...14.5	580
	F50P40	DN50		Ø 48		0...8.7	580
	F65P40	DN65		Ø 64		0...3.6	580
	F80P40	DN80		Ø 64		0...3.6	580
	N1HP40	DN100		Ø 64		0...3.6	580

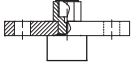
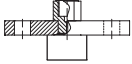
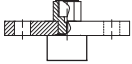
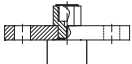
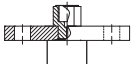
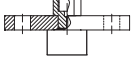

Diaphragm Seal Models (Direct or Remote Assembly) (Continued)

Model DRM	Code	Size	Note	Ø Diaphragm	Max. Media Temperature	Min. Span (PSIG)	Max. Span (PSIG)
<b>DRM-638</b> PN06 	F25P06	DN25	Flange to EN1092-1, capillary	Ø 24	482 °F	0...23.2	87
	F32P06	DN32		Ø 30		0...23.2	87
	F40P06	DN40		Ø 38		0...14.5	87
	F50P06	DN50		Ø 48		0...8.7	87
	F65P06	DN65		Ø 64		0...3.6	87
	F80P06	DN80		Ø 64		0...3.6	87
	F1HP06	DN100		Ø 64		0...3.6	87
<b>DRM-638</b> PN16 	F25P16	DN25	Flange to EN1092-1, capillary	Ø 24	482 °F	0...23.2	232
	F32P16	DN32		Ø 30		0...23.2	232
	F40P16	DN40		Ø 38		0...14.5	232
	F50P16	DN50		Ø 48		0...8.7	232
	F65P16	DN65		Ø 64		0...3.6	232
	F80P16	DN80		Ø 64		0...3.6	232
	F1HP16	DN100		Ø 64		0...3.6	232
<b>DRM-638</b> PN40 	F25P40	DN25	Flange to EN1092-1, capillary	Ø 24	482 °F	0...23.2	580
	F32P40	DN32		Ø 30		0...23.2	580
	F40P40	DN40		Ø 38		0...14.5	580
	F50P40	DN50		Ø 48		0...8.7	580
	F65P40	DN65		Ø 64		0...3.6	580
	F80P40	DN80		Ø 64		0...3.6	580
	F1HP40	DN100		Ø 64		0...3.6	580
<b>DRM-639</b> 150 lbs 	A25P150	1"	Flange to ASME B16.5, direct	Ø 30	176 °F	0...15	145
	A32P150	1¼"		Ø 38		0...15	145
	A40P150	1½"		Ø 38		0...15	145
	A50P150	2"		Ø 48		0...10	145
	A63P150	2½"		Ø 48		0...10	145
	A75P150	3"		Ø 64		0...4	145
	A85P150	3½"		Ø 64		0...4	145
A1HP150	4"	Ø 64	0...4	145			
<b>DRM-639</b> 300 lbs 	A25P300	1"	Flange to ASME B16.5, direct	Ø 30	176 °F	0...15	290
	A32P300	1¼"		Ø 38		0...15	290
	A40P300	1½"		Ø 38		0...15	290
	A50P300	2"		Ø 48		0...10	290
	A63P300	2½"		Ø 48		0...10	290
	A75P300	3"		Ø 64		0...4	290
	A85P300	3½"		Ø 64		0...4	290
A1HP300	4"	Ø 64	0...4	290			
<b>DRM-639</b> 600 lbs 	A25P600	1"	Flange to ASME B16.5, direct	Ø 30	176 °F	0...15	580
	A32P600	1¼"		Ø 38		0...15	580
	A40P600	1½"		Ø 38		0...15	580
	A50P600	2"		Ø 48		0...10	580
	A63P600	2½"		Ø 48		0...10	580
	A75P600	3"		Ø 64		0...4	580
	A85P600	3½"		Ø 64		0...4	580
A1HP600	4"	Ø 64	0...4	580			

No responsibility taken for errors; subject to change without prior notice.



## Heavy Duty Pressure Transmitter Model PAS

### Diaphragm Seal Models (Direct or Remote Assembly) (Continued)

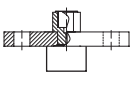
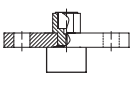
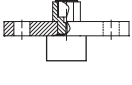
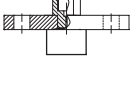
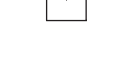
Model DRM	Size Code	Size	Note	Ø Diaphragm	Max. Media Temperature	Min. Span (PSIG)	Max. Span (PSIG)
<b>DRM-639</b> 1500 lbs 	A25P1K5	1"	Flange to ASME B16.5, direct	Ø 30	176 °F	0...15	1450
	A32P1K5	1¼"		Ø 38		0...15	1450
	A40P1K5	1½"		Ø 38		0...15	1450
	A50P1K5	2"		Ø 48		0...10	1450
	A63P1K5	2½"		Ø 48		0...10	1450
	A75P1K5	3"		Ø 64		0...4	1450
	A1HP1K5	4"		Ø 64		0...4	1450
<b>DRM-640</b> 150 lbs 	A25P150	1"	Flange to ASME B16.5, capillary	Ø 30	482 °F	0...15	145
	A32P150	1¼"		Ø 38		0...15	145
	A40P150	1½"		Ø 38		0...15	145
	A50P150	2"		Ø 48		0...10	145
	A63P150	2½"		Ø 48		0...10	145
	A75P150	3"		Ø 64		0...4	145
	A85P150	3½"		Ø 64		0...4	145
A1HP150	4"	Ø 64	0...4	145			
<b>DRM-640</b> 300 lbs 	A25P300	1"	Flange to ASME B16.5, capillary	Ø 30	482 °F	0...15	290
	A32P300	1¼"		Ø 38		0...15	290
	A40P300	1½"		Ø 38		0...15	290
	A50P300	2"		Ø 48		0...10	290
	A63P300	2½"		Ø 48		0...10	290
	A75P300	3"		Ø 64		0...4	290
	A85P300	3½"		Ø 64		0...4	290
A1HP300	4"	Ø 64	0...4	290			
<b>DRM-640</b> 600 lbs 	A25P600	1"	Flange to ASME B16.5, capillary	Ø 30	482 °F	0...15	580
	A32P600	1¼"		Ø 38		0...15	580
	A40P600	1½"		Ø 38		0...15	580
	A50P600	2"		Ø 48		0...10	580
	A63P600	2½"		Ø 48		0...10	580
	A75P600	3"		Ø 64		0...4	580
	A85P600	3½"		Ø 64		0...4	580
A1HP600	4"	Ø 64	0...4	580			
<b>DRM-640</b> 1500 lbs 	A25P1K5	1"	Flange to ASME B16.5, capillary	Ø 30	482 °F	0...15	1450
	A32P1K5	1¼"		Ø 38		0...15	1450
	A40P1K5	1½"		Ø 38		0...15	1450
	A50P1K5	2"		Ø 48		0...10	1450
	A63P1K5	2½"		Ø 48		0...10	1450
	A75P1K5	3"		Ø 64		0...4	1450
	A1HP1K5	4"		Ø 64		0...4	1450

Diaphragm Seal Models (Direct or Remote Assembly) (Continued)

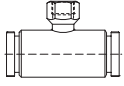
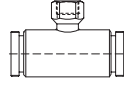
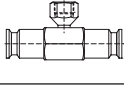
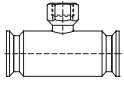
Model DRM	Size Code	Size	Note	Ø Diaphragm	Max. Media Temperature	Min. Span (PSIG)	Max. Span (PSIG)
<b>DRM 500</b> ISO Sterile 	D15	DN 15	Inline, direct	Inline	176 °F	0...23.2	580
	D20	DN20		Inline		0...23.2	580
	D25	DN25		Inline		0...8.7	580
	D32	DN32		Inline		0...8.7	580
	D40	DN40		Inline		0...5.8	580
	D50	DN50		Inline		0...5.8	580
<b>DRM 501</b> ISO Sterile 	D15	DN 15	Inline, capillary	Inline	176 °F	0...23.2	580
	D20	DN20		Inline		0...23.2	580
	D25	DN25		Inline		0...8.7	580
	D32	DN32		Inline		0...8.7	580
	D40	DN40		Inline		0...5.8	580
	D50	DN50		Inline		0...5.8	580
<b>DRM 502</b> Clamp ISO 2852 	D15	DN 15	Inline, direct	Inline	176 °F	0...23.2	580
	D20	DN20		Inline		0...23.2	580
	D25	DN25		Inline		0...8.7	580
	D32	DN32		Inline		0...8.7	580
	D40	DN40		Inline		0...5.8	580
	D50	DN50		Inline		0...5.8	580
<b>DRM 503</b> Clamp ISO 2852 	D15	DN 15	Inline, capillary	Inline	176 °F	0...23.2	580
	D20	DN20		Inline		0...23.2	580
	D25	DN25		Inline		0...8.7	580
	D32	DN32		Inline		0...8.7	580
	D40	DN40		Inline		0...5.8	580
	D50	DN50		Inline		0...5.8	580