



Model AFH2 Air Flow Hood

Specifications - Installation and Operating Instructions





Model AFH2 Air Flow Hood

Specifications - Installation and Operating Instructions

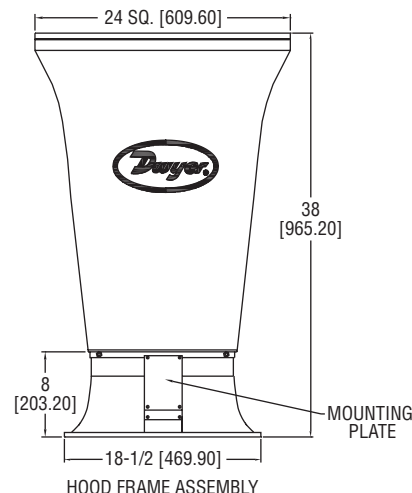

The Model AFH2 Air Flow Hood is designed to measure differential air pressure in and around commercial and industrial air handling systems. The AFH2 Air Flow Hood maintains a running average of measurements in the desired system. Using this product, you will have the ability to manually record measurements with the manometer on a given time interval. This unit also has an auto-zero feature and will auto-zero at user-defined intervals (this statement does not apply to l/sec, m³/hr or cfm mode, these modes are factory set to auto-zero every 10 seconds and this cannot be changed by the user). In addition to these features, the unit will alert you when its battery is running low in order to avoid recording inaccurate measurements. This lightweight flow hood is durable and easily stores in included travel case. New low flow adapter kit allows easy conversion of any AFH2 into a low flow hood. All kits fit easily into the AFH2's travel case.

SECTION 1: INTRODUCTION

1.1 **WARNING**

Do not use the digital manometer/capture hood unit for liquid or gas mixtures other than air. No responsibility will be taken by Dwyer Instruments, Inc. for any resulting damage to the unit or to operators if it is used with corrosive or other dangerous or explosive gas mixtures. When using the digital manometer/capture hood to check air flow at ceiling diffusers, make certain that you can raise and hold the unit safely during use. This instrument is not classified as flameproof or intrinsically safe; therefore they must not be used where an explosion hazard may exist. The unit is not authorized for use on life support applications.

Note: Observe standard safety procedures when working on ladders and scaffolding. Also ensure the unit does not become caught in moving machinery or on sharp objects.

ITEMS INCLUDED WITH THE AFH2 HOOD



1. Base unit with 2' x 2' (600 mm x 600 mm) hood.
2. Micromanometer
3. Carrying case
4. 1 pair of suction cup handles
5. 1 accessory pack (4 tubing adapters 2 mm x 6 mm, 1 neck sling, 2 bore flexible tubing 3 m x 2 mm)

1.2 **CAUTION**

- If stored under conditions outside normal operating range, allow the unit to stabilize at room conditions before use.
- Owing to its size and shape, take care when carrying the assembled unit from place to place.
- Avoid people and near-by equipment.
- Avoid sharp objects that may tear the capture hood.
- Turn the instrument off before storage or transportation and remove the batteries if storing for long periods or transporting by air.
- Make sure that the bellmouth/capture hood cable is not pinched by the mounting system. When not in use, the connector can be tucked behind the mount.
- Avoid subjecting the bellmouth sensing grid to excessive loading during use or assembly. Any air flow other than through the calibrated sensing holes, such as any hair-line cracks, will seriously affect the sensitivity.
- A damaged bellmouth sensing grid must be replaced, it cannot be repaired.
- Take care when fitting different sized canvas hoods of the protruding pins at the bellmouth.
- Do not disassemble the bellmouth sensing grid from the bellmouth molding. The retaining structure is specifically designed to accommodate loading due to normal operation.
- Under low humidity conditions, static electric charges may be encountered. These can be avoided by applying a suitable anti-static solution.

SECTION 2: DESCRIPTION

2.1 Power Supply

The manometer is powered by one 9V battery or equivalent. The battery is contained in the battery compartment, which is accessible by removing the clip-on cover on the back of the digital manometer.

To conserve battery power, the instrument has an AUTO-OFF feature that may be turned on or off. If you wish to learn how to use this feature of the digital manometer, please see page 6 (Setting the Switch Off Period).

2.1.1 Battery Selection: 9 volt or equivalent battery.

2.1.2 Installing the Battery

1. Remove the manometer from its rubber casing.
2. Remove the battery compartment cover by pressing and sliding in the direction of the arrow.
3. Insert the proper 9V connection to the top of the battery in the correct orientation.
4. Replace the battery compartment cover and ensure it is clipped in place.
5. Place the manometer back into its rubber holder.

2.2 Assembly

The nylon capture hood is extended and tensioned using 4 glass-fiber stiffening poles placed between the molding and the hood frame. Note: The degree of flexing required to fit the poles will vary with the hood.

Erecting the Hood

Note: Refer to the appropriate pole-arrangement diagram.

1. Remove the hood assembly from the carrying case and place on the ground with the hood attachment upwards.
2. Remove the 4 stiffening poles from their packaging. Place them somewhere accessible from a standing position.
3. Leaving the bellmouth on the ground, unfurl the hood and open. Remove out of its hinged frame.
4. Holding the frame against your body with one hand on the opposite side, insert the lower end of a pole into one of the poles already attached to the corner of the bellmouth molding. Locate the upper end of the pole into the hole at the opposite corner of the capture hood.
5. Repeat this process next for the diagonally opposite pole – flexing of the poles may be necessary, depending on the hood. When these two poles have been inserted the assembly will be more-or-less self supporting on one side.
6. Repeat this process for the opposite side and the two remaining poles.

BASE UNIT WITH HOOD AND FRAME STRUCTURE

Assembly of 2 x 2' (600 x 600 mm) Frame



SPECIFICATIONS

Service: Air.

Volume Flow Rate Units: CFM, l/s, m³/hr.

Volume Flow Ranges:

Supply: CFM: 41 to 1176; l/s: 19 to 555; m³/hr: 69 to 2000;
Exhaust: CFM: 45 to 1176; l/s: 21 to 555; m³/hr: 76 to 2000.

Volume Flow Ranges with Low Flow Kit:

Supply: CFM: 25 to 1176; l/s: 12 to 555; m³/hr: 43 to 2000;
Exhaust: CFM: 29 to 1176; l/s: 14 to 555; m³/hr: 49 to 2000.

Accuracy @ 20°C (68°F):

Supply: ±3% of reading ±9 CFM (±4 l/s, 14 m³/hr);
Exhaust: ±3% of reading ±9 CFM (±4 l/s, 14 m³/hr).

Span Stability v. Temperature: Better than 0.1% of range in use per 2°F (1°C).

Zero System Accuracy: ±1 count (±0.05 Pascal typical; ±0.0002 in w.c.).

Temperature Limits:

Operating: 32 to 122°F (0 to 50°C);
Storage: 23 to 122°F (-5 to 50°C).

Thermal Effect: ±0.1% of range in use per 2°F (1°C).

Zero Drift: Negligible due to auto zero system. When auto zero set at 30 second intervals (2 minute warm up).

Orientation Effect: Any 45 degree change 0.0004 in w.c. (0.1 pascal typical).

System Air Leak: 0.366 in³/hr (0.1 ml/min) @ 20 in w.c. (5 kPa) typical.

Maximum Differential Pressure: 60 in w.c. (15 kPa).

Auto Ranging Display: 0.375" high digits.

Resolution: 1 CFM, 1 l/s, 1 m³/hr.

Output: RS-232 serial interface (baud rate 9600).

Memory Capability: 2500 readings in any engineering unit.

Power Requirements: 8.4 V NiMH battery, installed functional, user replaceable (optional 9 V alkaline battery may be used in place of rechargeable).

Dimensions: 30" x 24" x 24" (965 x 610 x 610 mm). Hood only: 2' x 2' (600 mm x 600 mm).

Weight: 8.8 lb (4 kg).

Agency Approval: CE.

Hood Handles

Installation: Ensure that the base unit is clean and dry. Flip up the latches on each handle. Apply the handles to the base unit. Flip down the latches to secure the handles. Test each handle by pulling gently on it, if there is any movement remove the handle and repeat the installation process.

Removal: Flip up the latches on each handle. If necessary, slide a finger under the suction pad to release the suction. **DO NOT** attempt to remove the handles without releasing the latches as this could cause damage.

CAUTION Check the handles before use and contact Dwyer Instruments, Inc. immediately if any components are missing or damaged.

- Check before use that all components are securely fastened.
- **DO NOT** apply more than 45 kg of force to the handles.
- Dwyer Instruments, Inc. does not accept liability for any damage or injury caused by improper use.

Positioning of Handles:

- Both handles can be fitted to the inside of the base.
- Both handles can be fitted to the outside of the base.
- One handle can be fitted to the inside and the other to the outside of the base.

Connecting the Digital Manometer

1. Attach the instrument to the steel plate.
2. Connect the blue hose to the Reference port on the instrument. Connect the clear hose to the Signal In port on the instrument.

2.3 Disassembly

Disassembly is essentially the reverse of the assembly procedure.

Disconnecting the Instrument

1. Disconnect the hoses from the digital manometer.
2. Detach the manometer from the metal plate.
3. Collapse the capture hood.
4. Store the instrument and components in the travel case.

ASSEMBLING OPTIONAL FRAMES

The frames are fitted together using nuts. Each frame consists of the corner pieces 1, 2, 3, and 4 and additional pieces can be inserted between these to create different sized frames.

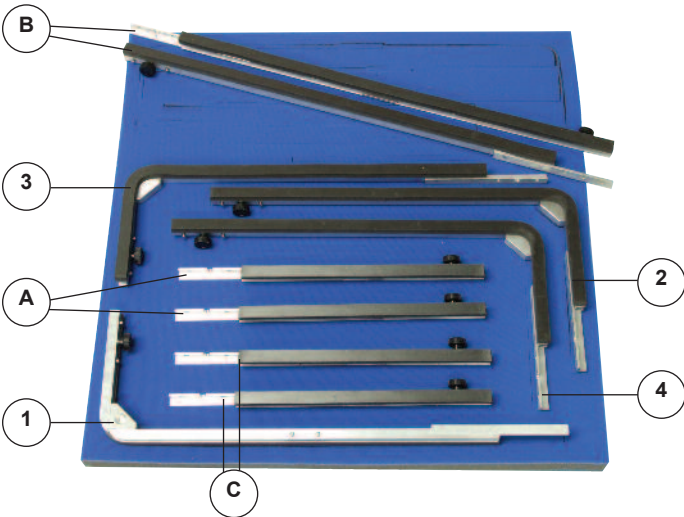

Optional hoods: 1 x 4' (300 x 1200 mm), 2 x 4' (600 x 1200 mm), 1 x 5' (300 x 1500 mm), 3 x 3' (900 x 900 mm)

1 x 4' (300 x 1200 mm) Canvas Model A-176

Use Parts 1 + 2 + 3 + 4 + A + A from A-175 Hood Adapter Kit. Fit one A piece between pieces 1 and 2 and the other between pieces 3 and 4, then join piece 1 to piece 4 and piece 2 to piece 3. Attach the smaller end of the 1 x 4' (300 x 1200 mm) hood to the base and slot the larger end into the channels in the frame ensuring that the canvas is not caught. Fit the poles so that they run parallel to the side seams as shown in picture.

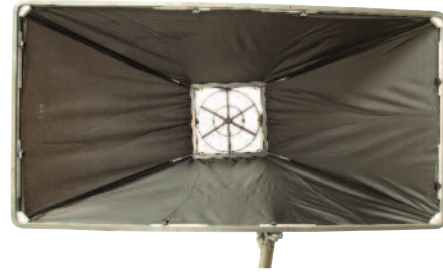

2 x 4' (600 x 1200 mm) Canvas Model A-177

Use Parts 1 + 2 + 3 + 4 + A + A + C + C from A-175 Hood Adapter Kit. Fit one A piece between pieces 1 and 2 and the other between pieces 3 and 4, then fit one C piece between pieces 2 and 3 and the other between pieces 1 and 4. Attach the smaller end of the 2 x 4' (600 x 1200 mm) hood to the base and slot the larger end into the channels in the frame ensuring that the canvas is not caught. Fit the poles so that they run parallel to the side seams as shown in picture.



3 x 3' (900 x 900 mm) Canvas Model A-179

Use Parts 1 + 2 + 3 + 4 + B + B from A-175 Adapter Kit. Fit one B piece between pieces 2 and 3 and the other between pieces 1 and 4, then fit piece 1 to piece 2 and piece 3 to piece 4. Attach the smaller end of the 3 x 3' (900 x 900 mm) hood to the base and slot the larger end into the channels in the frame ensuring that the canvas is not caught. Fit the poles so that they run parallel to the side seams as shown in picture.

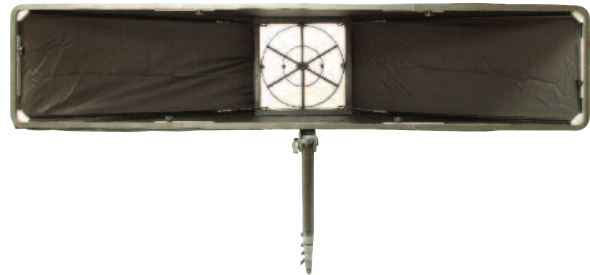

1 x 5' (300 x 1500 mm) Canvas Model A-178

Use Parts 1 + 2 + 3 + 4 + B + B from A-175 Hood Adapter Kit. Fit one B piece between pieces 1 and 2 and the other between pieces 3 and 4, then join piece 1 to piece 4 and piece 2 to piece 3. Attach the smaller end of the 1 x 5' (300 x 1500 mm) hood to the base and slot the larger end into the channels in the frame ensuring that the canvas is not caught. Fit the poles so that they run parallel to the side seams as shown in picture.

Assembling A-174 Low Flow Hood

Adapter plate A, 15.7" x 15.7" canvas and four (4) extension poles are used to assemble the low flow hood. The adapter plate is placed on top of the sensor grid beneath the brass fittings.

- To remove:** Gently pull until the adapter plate slides out of place.
- To replace:** Slot the adapter plate underneath the brass fittings on one side of the grid and push gently until it slots beneath the second pair of brass fittings.

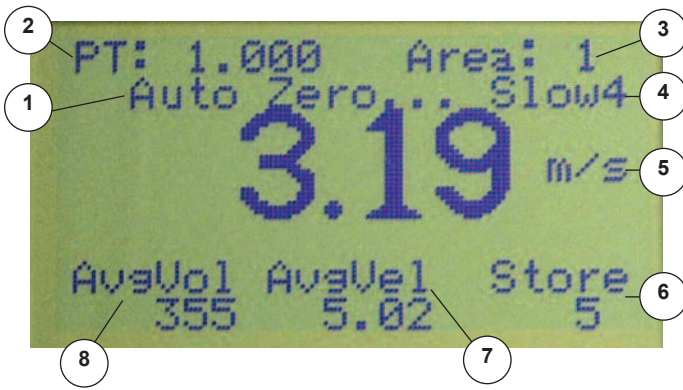
MICROMANOMETER DISPLAY

1. Whenever the auto zero sequence is initiated manually or at power-up, auto zero will be displayed until the cycle is complete. Being an auto ranging instrument, the resolution and decimal points will change according to the pressure being applied.
2. Shows the Pitot tube or Hood Factor. Use the Units key to toggle to the Hood Mode, this will show the Hood Factor.
3. Shows the area setting.
4. Displays which mode the instrument is in. Press the fast/slow key to change the mode.
5. Engineering Units; use the Units key to toggle between units of measurement.
6. Number of readings stored. (Up to 2500 readings can be stored).
7. Displays the average velocity of the readings stored.
8. Shows the average volume of the readings stored (l/s, cfm or m³/hr).













2.4 Digital Manometer Features**Auto Zero System**

Cycle will start to operate as soon as the instrument is switched on. This is factory set, initially set at a 30 second interval upon switching the unit ON and thereafter set at 60 second intervals. See user menu set up to change this timing. The instrument contains a miniature solenoid valve, which isolates the pressure sensors during the auto zero process, and the valve emits to clearly audible clicks, which signal the start and end of the auto zero process. The auto zero system can be overridden at any time by pressing ZERO. Timing intervals may be changed in the user menu from 30 seconds to 600 seconds, or the auto zero system may be turned off completely.

Battery Low Monitoring

The battery condition is monitored every time the instrument auto zeros. When the battery low warning appears, the battery must be replaced immediately, otherwise the readings obtained will be unreliable. If at anytime the readings seem suspect auto zero the instrument manually and this will check the battery condition, if in doubt then replace the battery.

KEY PAD CONTROLS:

-  **ENABLE:** Protects against accidental switching of the instruments power source.
-  **ON:** Is used in conjunction with the enable key to switch on the instrument.
-  **OFF:** Is used in conjunction with the enable key to switch off the instrument.
-  **FAST / SLOW:** Smoothes out the response to applied pressure changes. Time constant: Fast = 0 seconds. Slow 1 = 5 seconds. Slow 2 = 10 seconds. Slow 3 = 15 seconds. Slow 4 = 20 seconds.
-  **UNITS:** Changes units of measurement.
-  **STORE:** To be used when storing readings manually.
-  **MENU:** Options are activated to select the appropriate functions before carrying out any measurement.
-   **UP / DOWN:** To operate the backlight; to select an appropriate function during the menu operation; and to toggle between supply and exhaust in Hood mode.
-  **BACKSPACE:** Backspace.
-  **ENTER:** Accepts commands from the menu operation, and gives access to user menu when used in conjunction with ENABLE and ON keys.
-  **ZERO:** Zeroes the instrument manually, overriding the auto-zero system.

Audible Feedback

Audible noise should be heard every time a key is pressed while the instrument is on.

Units

Each time this key is pressed, the units of the measurement selected is shown on the right hand side of the display. Being an auto ranging unit, the correct resolution and the decimal point will be displayed according to the pressure being applied.

MENU OVERVIEW

Menu: There are two variants of the MENU.

- a. "User Menu" - This sets the instruments default values, which are factory set, but can be customized to individual requirements. This will change the values permanently.
 - Note:** Permanently changing certain default settings may give rise to incorrect readings.
- b. "Option Menu" - This sets or changes the default settings temporarily.

HOW TO SET THE USER MENU

PRESS ENTER, ENABLE AND ON KEYS AT THE SAME TIME UNTIL USER MENU APPEARS ON DISPLAY

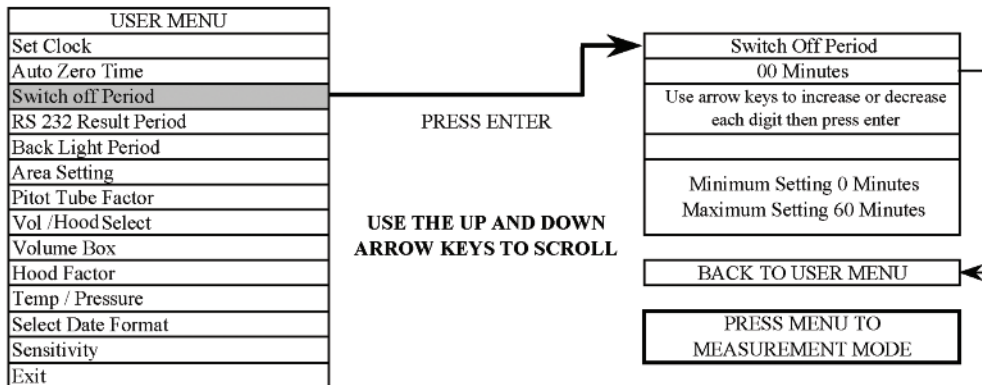
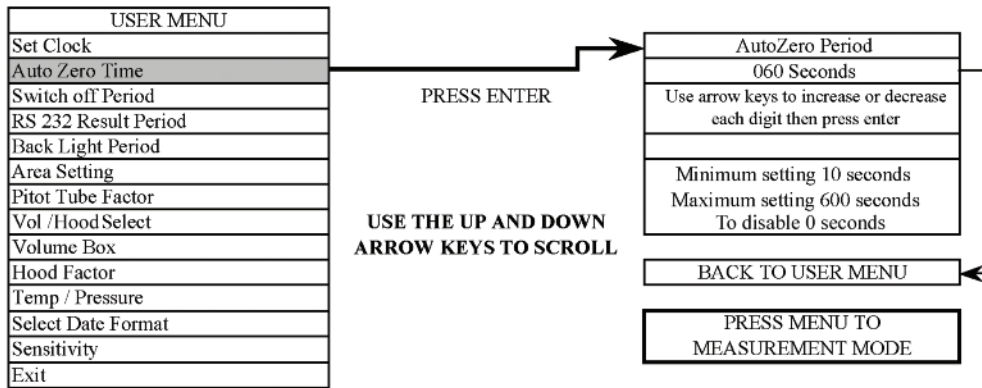
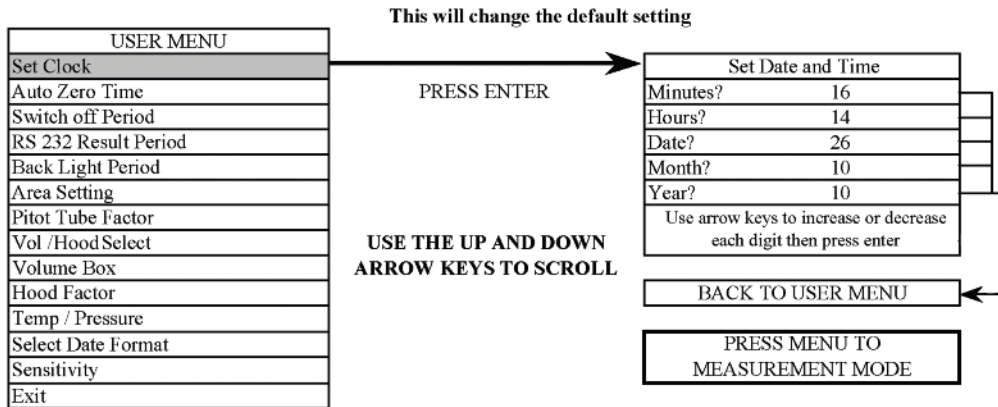

HOW TO SET THE USER MENU

PRESS ENTER, ENABLE AND ON KEYS AT THE SAME TIME UNTIL USER MENU APPEARS ON DISPLAY

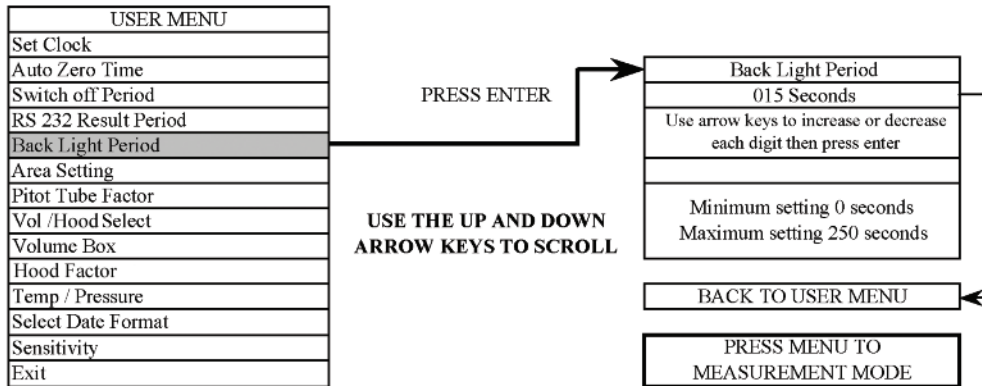
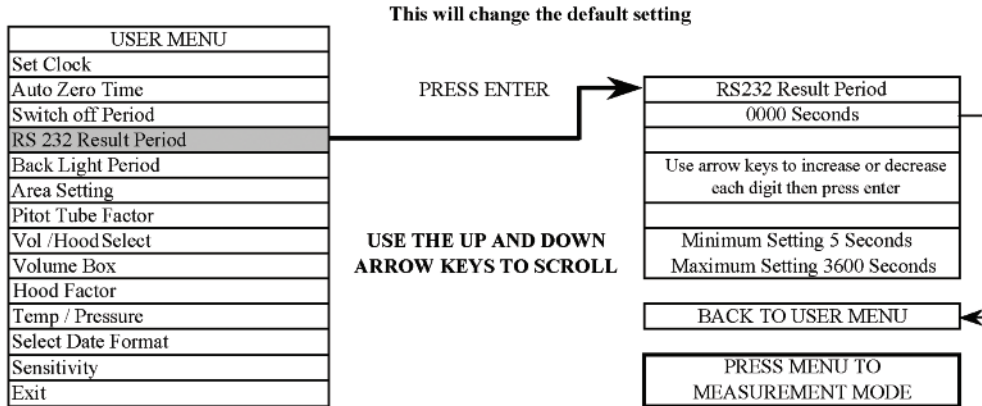

HOW TO SET THE USER MENU

PRESS ENTER, ENABLE AND ON KEYS AT THE SAME TIME UNTIL USER MENU APPEARS ON DISPLAY

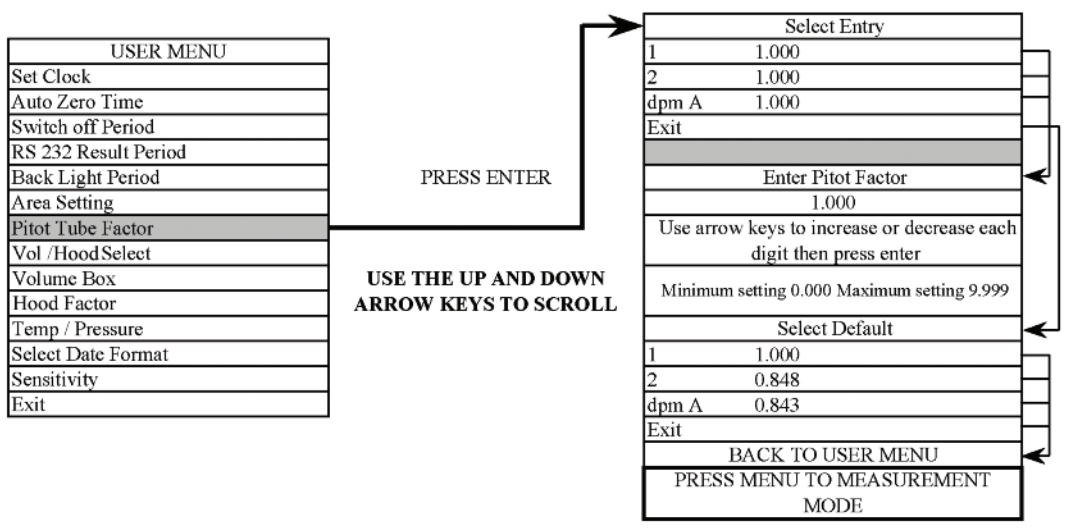
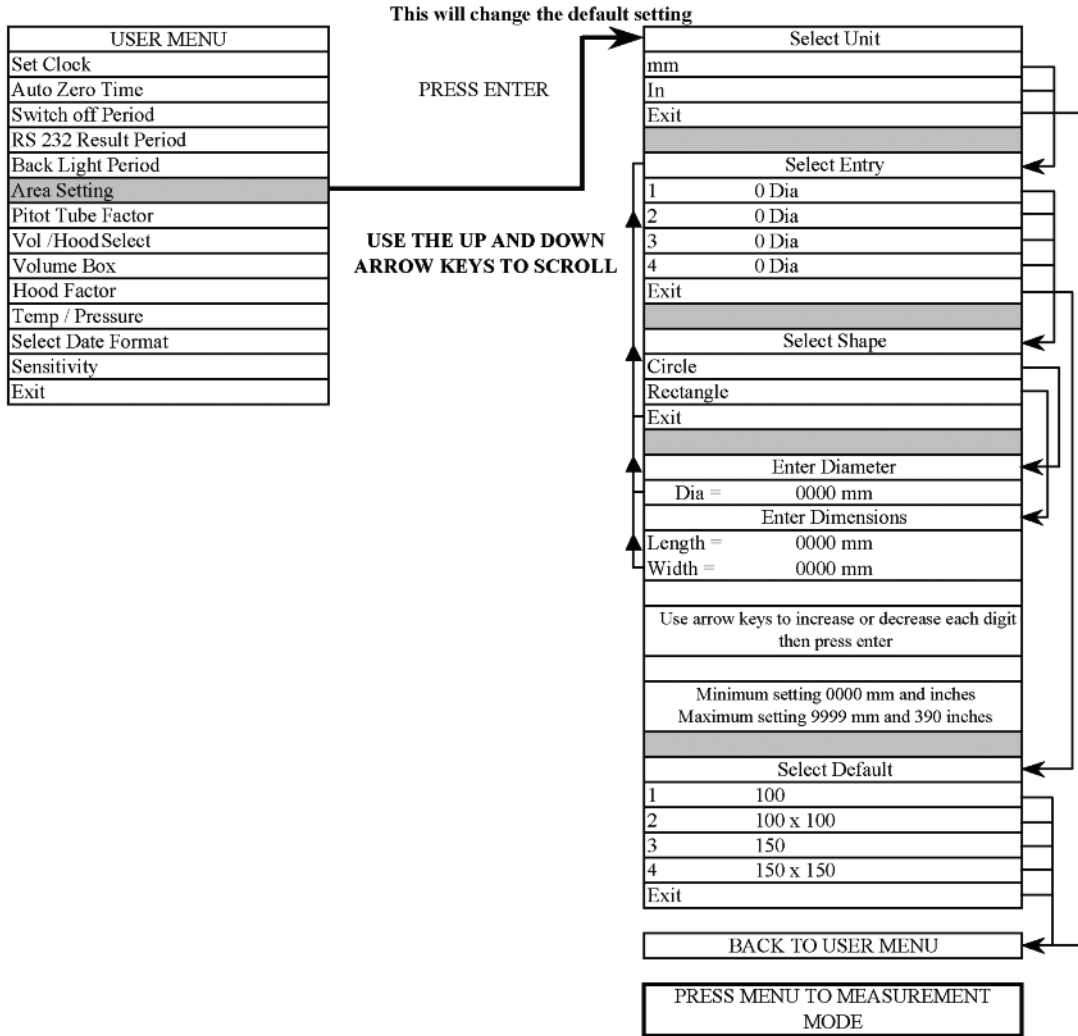

HOW TO SET THE USER MENU

PRESS ENTER, ENABLE AND ON KEYS AT THE SAME TIME UNTIL USER MENU APPEARS ON DISPLAY

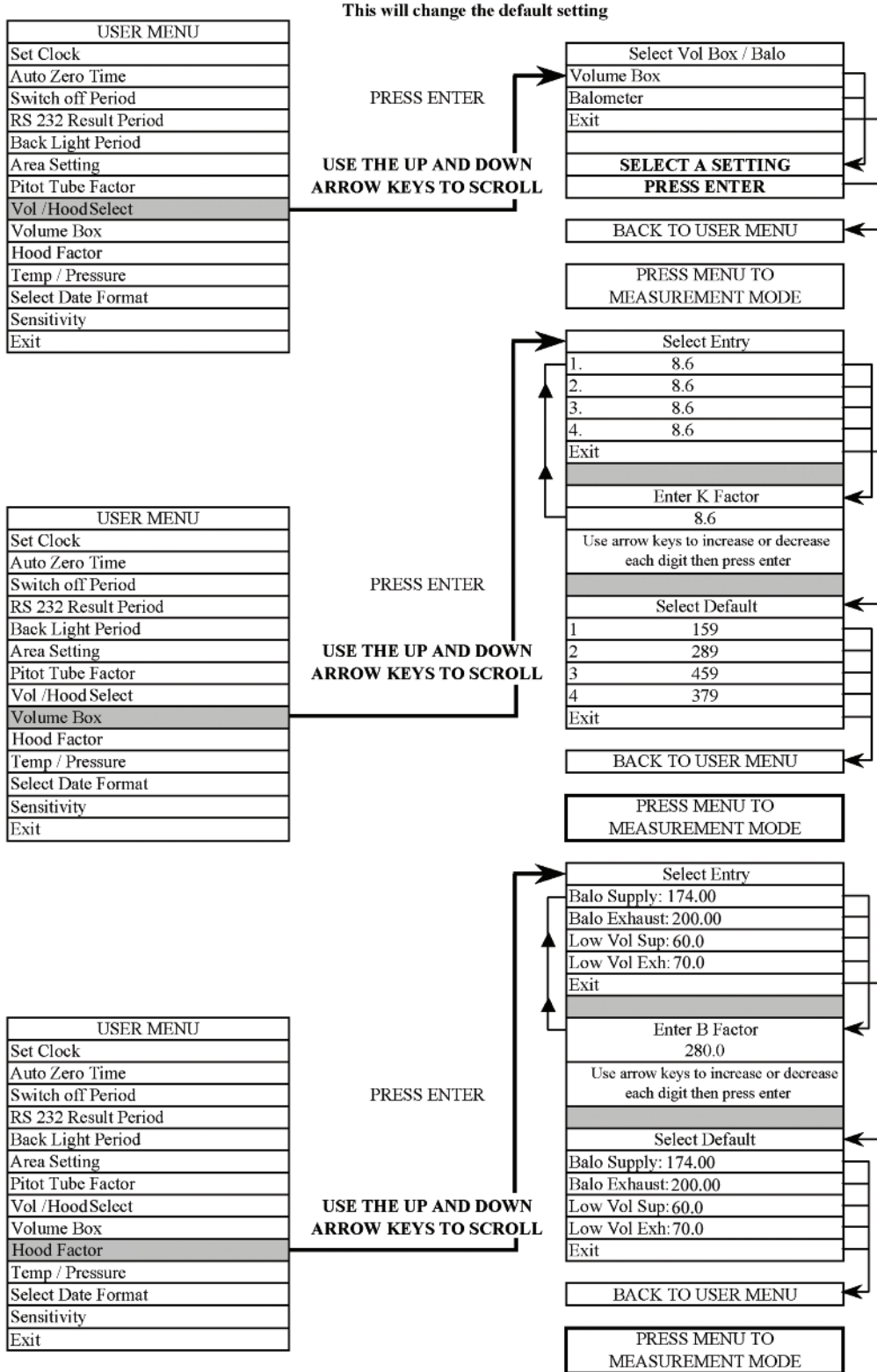

HOW TO SET THE USER MENU

PRESS ENTER, ENABLE AND ON KEYS AT THE SAME TIME UNTIL USER MENU APPEARS ON DISPLAY

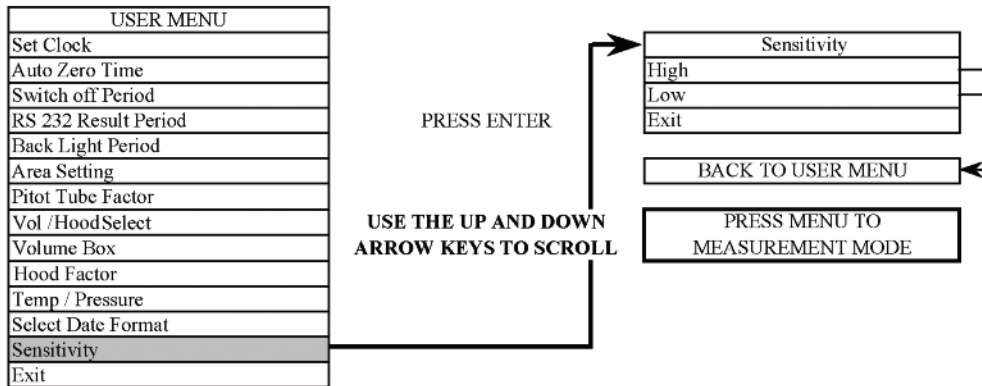
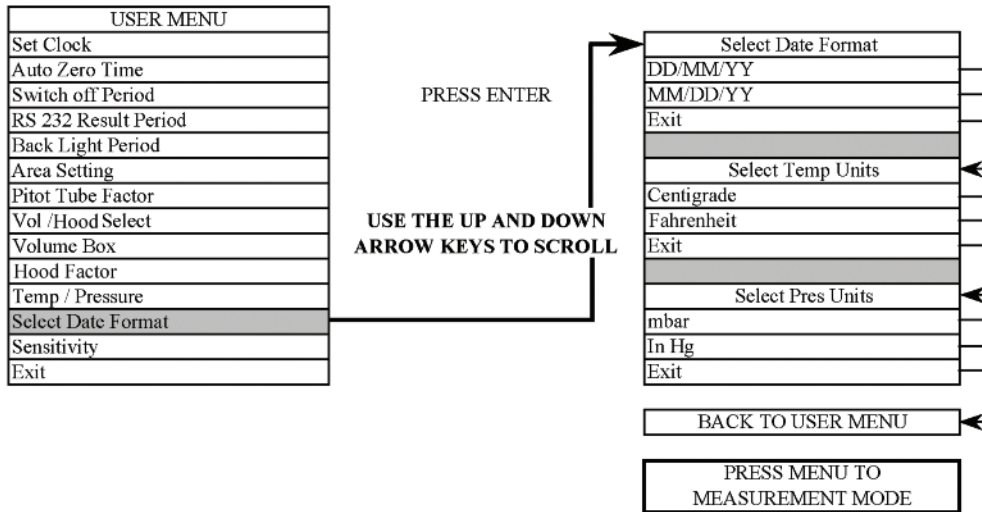
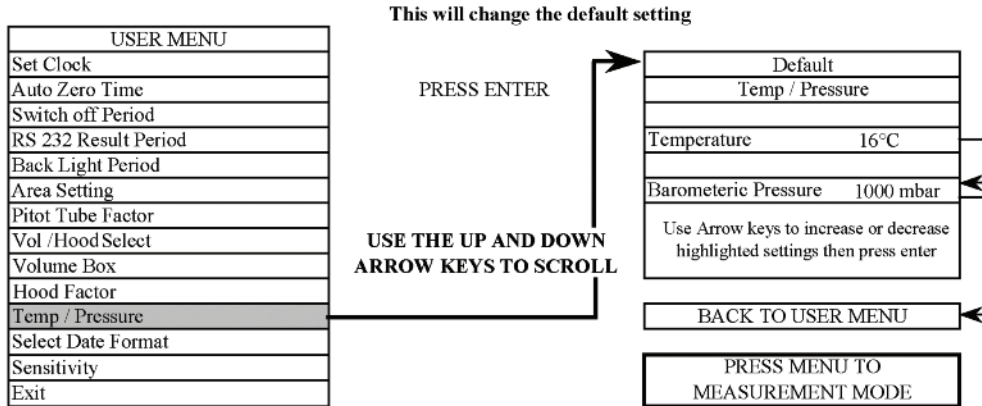

PRESS MENU KEY TO ACCESS THE OPTION MENU

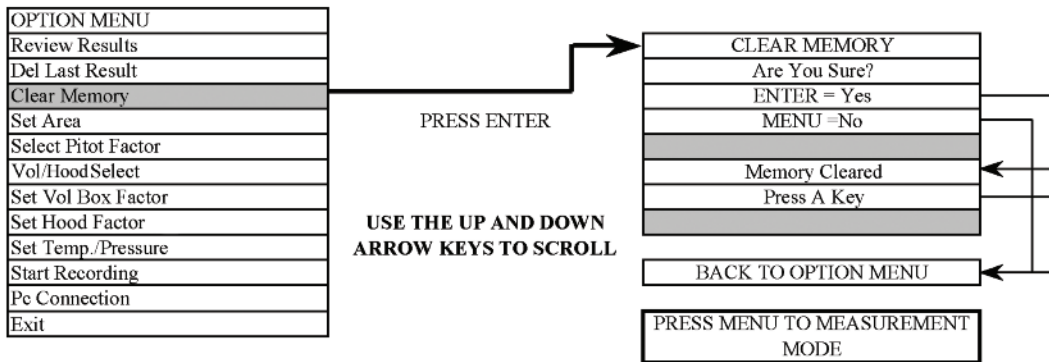
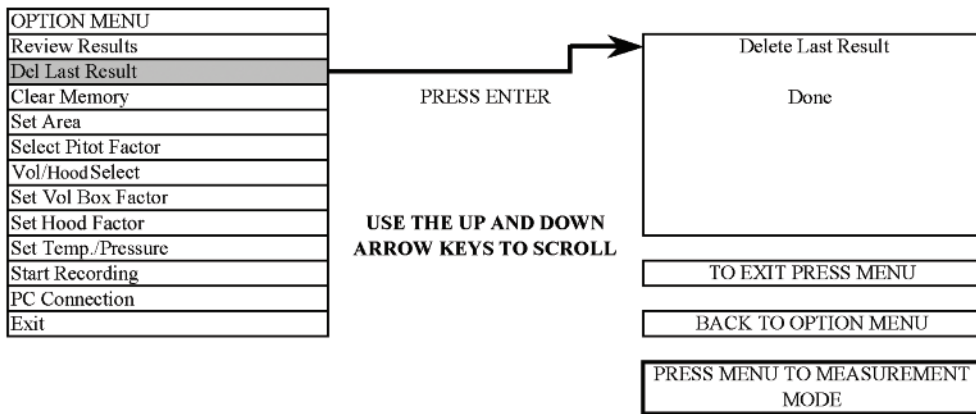
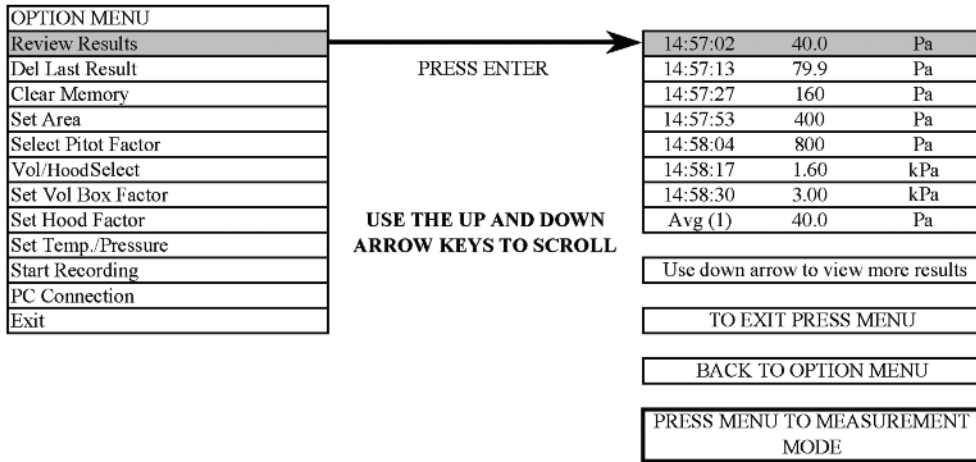

PRESS MENU KEY TO ACCESS THE OPTION MENU

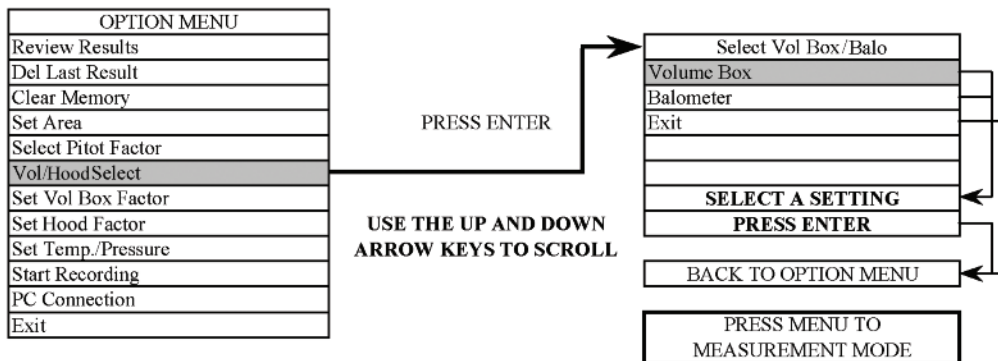
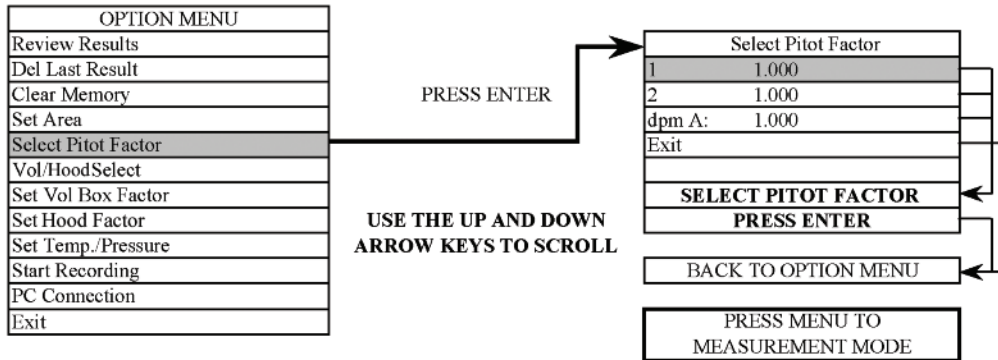
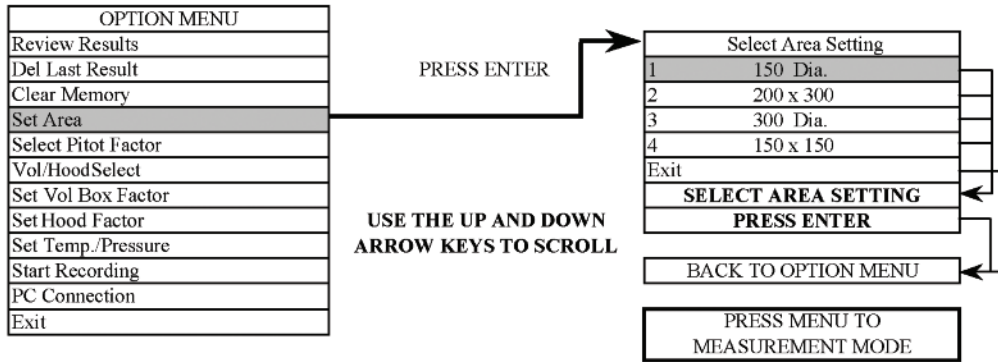

PRESS MENU KEY TO ACCESS THE OPTION MENU

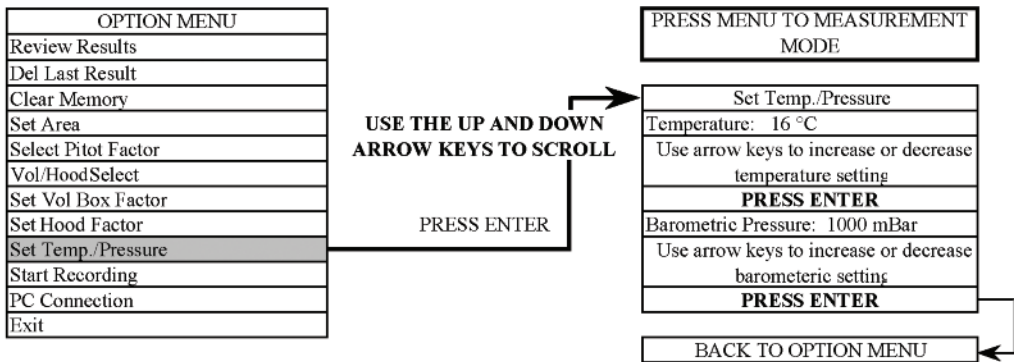
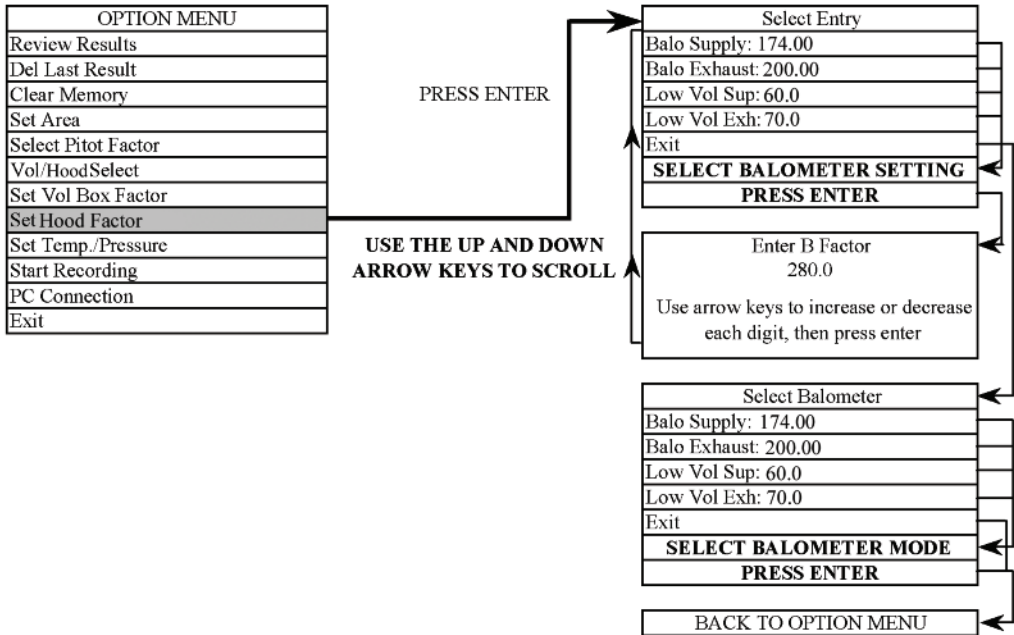
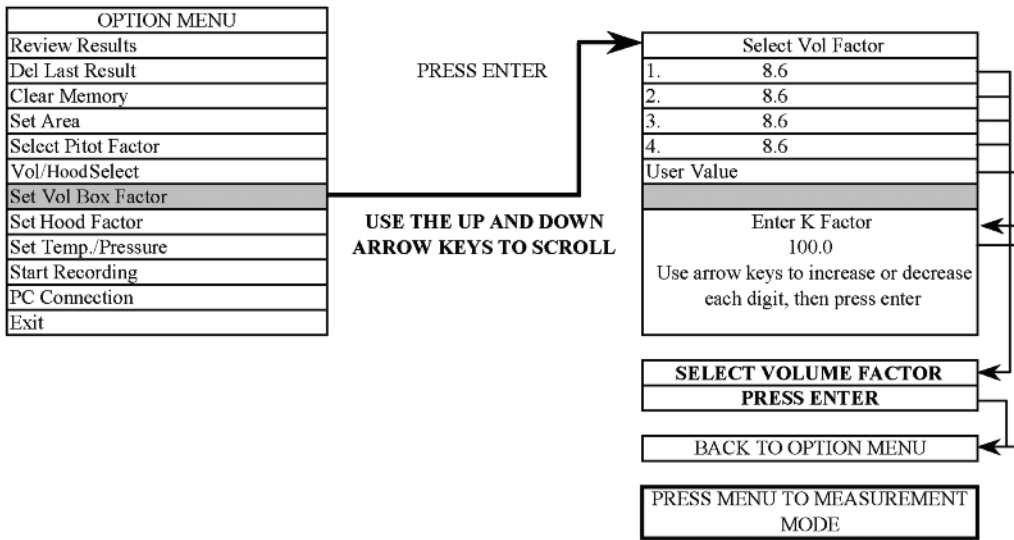

PRESS MENU KEY TO ACCESS THE OPTION MENU

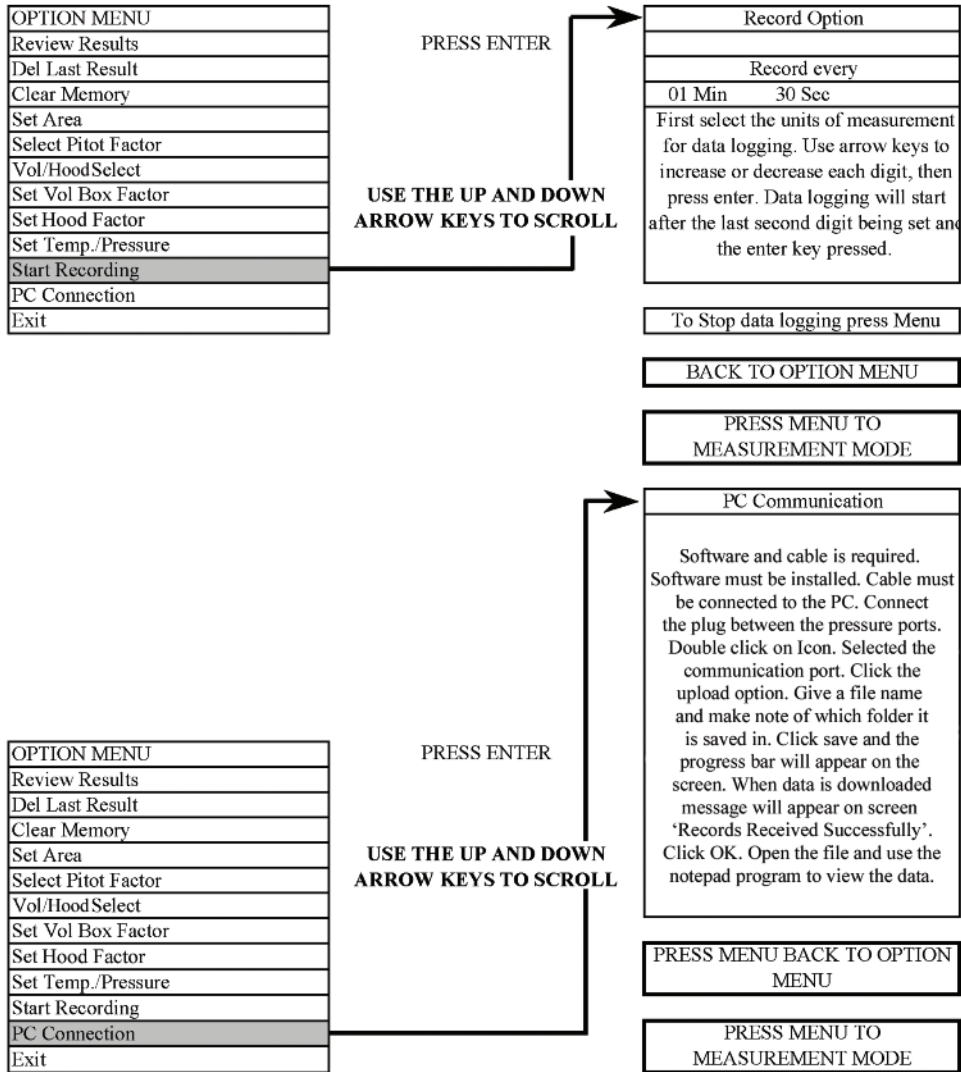

Only use genuine cable and diskette. If any other accessories are used or the incorrect downloading software is used then the guarantee on the instrument and the accessories becomes null and void.

ACCESSORIES

A-190, Software and Cable

Making Measurements

The capture hood can be used on either supply or exhaust flows. Which of these factors you will use depends on where in the duct you wish to measure the air flow rate. Press the UNITS key until L/s, m³/hr or cfm appears on the right-hand-side of the display. Use the Up and Down arrow keys to toggle between the Hood Supply and Hood Exhaust factors, which are shown in the top line of the display.

ATD Factors (Air Terminal Device Factors)

The Air Terminal Device Factors consist of the following factors: Hood Supply Factor, Hood Exhaust Factor, Pitot Tube Factor, Low Volume Supply Factor, and the Low Volume Exhaust Factor. It is not recommended that one change these factors permanently. If for any reason you do and need to set them back to the default, the default factors are as follows:

Hood Supply Factor	174.0
Hood Exhaust Factor	200.0
Pitot Tube Factor	1.000
Low Volume Hood Supply	60.0
Low Volume Exhaust Factor	70.0

The instrument can store up to 2 Pitot Tube factors. These can be input via the User Menu. In order to select a Pitot Tube factor, press the MENU key while in measurement mode, scroll to Select Pitot Factor using the Up and Down arrow keys and press the ENTER key. Use the Up and Down arrow keys to select the desired Pitot Tube factor and press the ENTER key. Press the MENU key to return to measurement mode. Press the UNITS key until m/s or ft/min is displayed on the right-hand-side of the screen. The selected Pitot Tube factor will be displayed in the top line of the display on the left-hand-side.

Measuring Volume Flow

Select the duct shape and input the dimensions in millimeters or inches. When storing the data manually in m/sec or ft/min, the display shows the average value. The resulting value is then multiplied with the area to give the volume (providing that the stored value is of the same units). The resulting figure will either be in liters/sec or CFM depending on the model.

Downloading

PC Connection: Connect the RS232 Plug to the instrument located between pressure parts and fit 9-way "D" type connector to the serial port of the PC. Ensure that the software is loaded on the PC using the provided diskette. Switch on the instrument and select PC Connection mode via the Menu (See the Option Menu section). Double click the icon (under the heading "Manometer Up Load"). Message will appear on the screen to give it a file name and save that file in appropriate location. Ensure that the file is saved under the TXT format. Click on the file and open with the Note Pad program and the data will be displayed in the format:

Time	Date	Measured	Unit of
Stamp	Stamp	Value	Measurement

Note: Only use genuine cable and software. If any other accessories are used or the incorrect downloading software is used then the instrument's warranty becomes null and void.

SECTION 3: BACK PRESSURE

When using the capture hood, it can slightly restrict the flow coming out of the diffuser causing some back pressure on the system. This added resistance may alter the true air flow, however in most cases this error is likely to be less than the accuracy of the instrument.

SECTION 4: TROUBLE SHOOTING

Problem	Possible Causes
No Display on Switch On	<ul style="list-style-type: none"> No batteries fitted Batteries fitted but have incorrect orientation (wrong polarity) Batteries exhausted
Instrument Stops Working (no display on LCD)	The Unit may not be switched on. Make sure it did not automatically turn itself off if it is set on automatic turn-off mode.
Inconsistent Measurements	Low Battery
Data Not Downloaded to Computer	<ul style="list-style-type: none"> Computer is connected incorrectly Computer is configured incorrectly Incorrect printer cable is being used If none of these issues are causing your problem, please contact Dwyer.

SECTION 5: MAINTENANCE

Some simple routine maintenance after each use will ensure that your instrument/capture hood will function correctly for many years.

- Remove any moisture droplets using a clean, absorbent cloth/paper before disassembling and storing the unit.
- Remove battery if the unit is to be stored, unused for an extended period of time.
- Always store and transport the unit carefully. Store in dry conditions.
- DO NOT immerse the instrument in water.
- DO NOT use abrasive cleaning products. Bellmouth molding manifold and hood can be wiped clean with a damp cloth and dried.
- DO NOT immerse the bellmouth in water.
- DO NOT use abrasive cleaning products, which may block or damage the manifold grid. Grid may be CAREFULLY wiped clean with a cloth. Ensure Pitot tube holes are not contaminated with moisture.
- DO NOT use abrasive cleaning products that may damage the grid, or may leave a residue in or around the holes.
- DO NOT attempt to remove the grid from the bellmouth molding.
- CHECK periodically for damage or any visible cracks.
- Take care NOT to damage or obscure the calibrated holes in the tubes. This can seriously affect the measurements obtained.

Capture hood fabric can be wiped clean with a damp cloth, if necessary, and moisture droplets dried with an absorbent cloth/paper. Periodically, wash in cool water using a mild detergent. Drip dry, ensuring it cannot become caught on any sharp objects.

The fabric used is impermeable, tough, and very resistant under normal use. In the event that the fabric becomes worn or torn, replace the fabric hood immediately. A damaged hood will seriously affect the measurements taken.

Anti-static solution can be applied to the instrument by using a clean, lint-free cloth and carefully rubbing it over the instrument case and window.
Note: This is normally only necessary when working in low-humidity conditions.

Upon final installation of the Model AFH2 Air Flow Hood, no routine maintenance is required. A periodic check of system calibration is recommended. The Model AFH2 is not field serviceable and should be returned if repair is needed (field repair should not be attempted and may void warranty). Be sure to include a brief description of the problem plus any relevant application notes. Contact customer service to receive a return goods authorization number before shipping.

CONVERSION TABLES

Pressure			
Pascal	mmH ₂ O	mbar	inH ₂ O
1	0.102	0.010	0.004
9.806	1	0.098	0.039
100	10.20	1	0.402
249.1	25.40	2.491	1

Velocity	
m/sec	ft/min
1	196.85
0.005	1

Volume			
m ³ /sec	m ³ /hr	l/sec	CFM
1	3600	999.97	2118.88
0.0002	1	0.2777	0.5885
0.001	3.6	1	2.1189
0.0004	1.699	0.4719	1

AIR VELOCITY CALCULATIONS USING S.I. SCALES

The standard formula for calculating velocity pressure is $V = 1.291 \sqrt{P_v}$. This is only correct for an air density of 2.1kg/m³.

For non-standard air conditions this equation becomes:

$$V = 1.291 \sqrt{\frac{1013.25}{B} \times \frac{T}{293} \times P_v}$$

V = velocity m/s

B = Barometric pressure mbar

T = absolute temperature °K

(= t °C + 273 where t = airstream temperature)

P_v = velocity pressure Pa

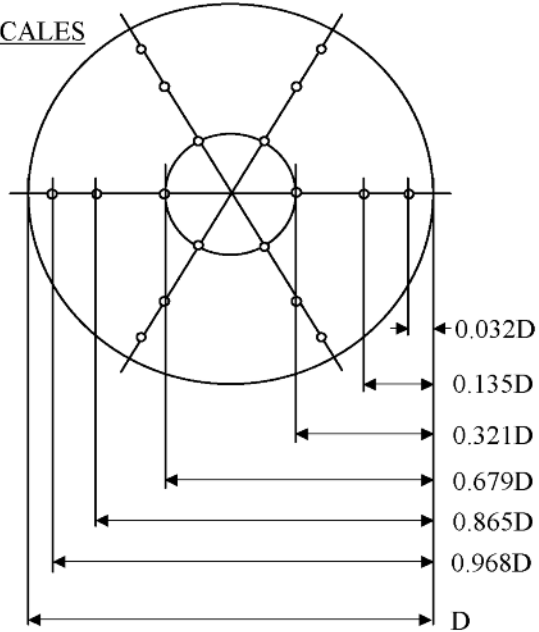

Log Linear for traverse points on 3 diameters in a circular duct

AIR VELOCITY CALCULATIONS USING IMPERIAL SCALES

The standard formula for calculating velocity pressure is $V = 4000 \sqrt{P_v}$. This is only correct for an air density of 0.074 lbs/ft³.

For non-standard air conditions this equation becomes:

$$V = 4000 \sqrt{\frac{30}{B} \times \frac{T}{528} \times P_v}$$

V = velocity ft/min

B = Barometric pressure in Hg

T = absolute temperature °R

(= t °F + 460 where t = airstream temperature)

P_v = velocity pressure wg

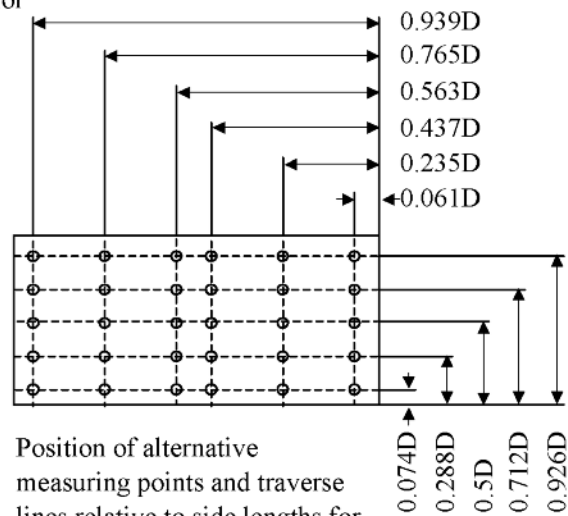

Position of alternative measuring points and traverse lines relative to side lengths for regular ducts