

rotork®

Keeping the World Flowing

Remote Hand Station

Remote field operation for
3rd generation IQ and SI actuators

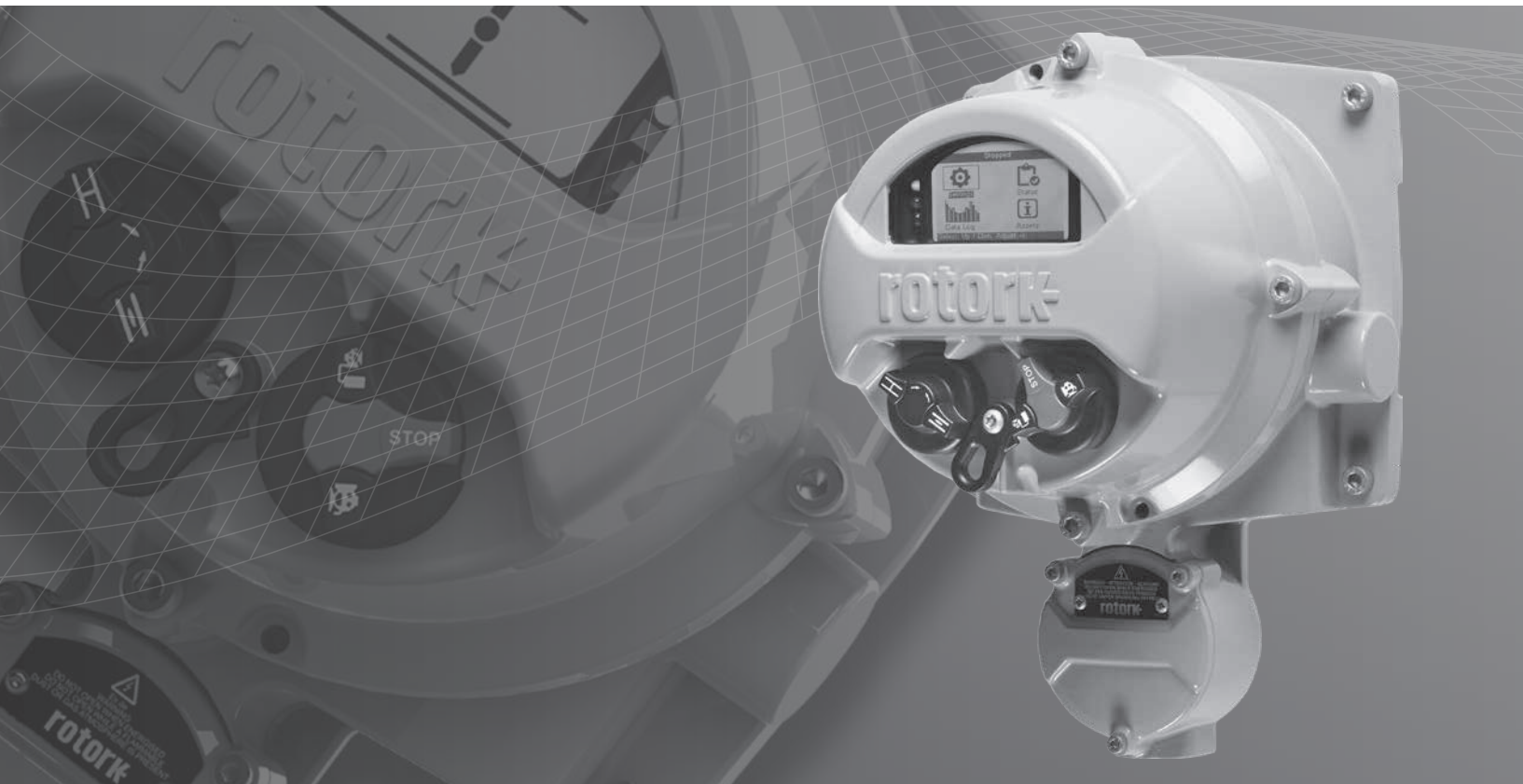

Safe Use and Installation Manual

Contents

Section	Page
1 - Introduction	3
2 - Health and Safety	4
3 - Remote Hand Station Mounting	5
4 - Electrical Connections	6
5 - Enabling Remote Hand Station Mode on an IQ Range Actuator	8
6 - Enabling Remote Hand Station Mode on an SI Range Actuator	9
7 - Remote Hand Station Settings	10
8 - Operating the Remote Hand Station	12
9 - Approvals	13
10 - Environmental	15

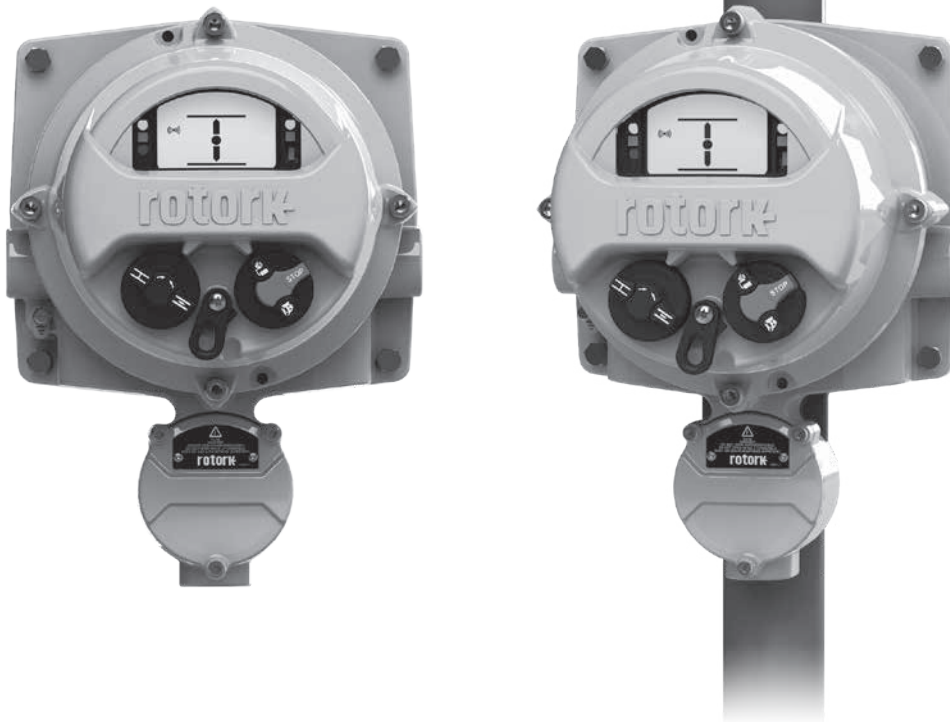

1 - Introduction

Actuators used in many industries sometimes have to be mounted in places where it is hazardous, inconvenient or just unpleasant for a human to operate. In these cases it is useful to be able to see the status and locally operate an actuator from a safe distance.

Typically in this situation you would be faced with a simplistic interface for basic operation and indication, however Rotork's enhanced solution allows the user to have an exact replication of the actuator interface.

Using the same display and controls interface from Rotork 3rd generation IQ and SI actuators, users can remotely operate, interrogate and configure a Rotork actuator from up to 100 m distance. Due to the familiar, feature rich interface, set up couldn't be simpler using the Rotork Bluetooth® Setting Tool *Pro* supplied with the actuator.

Retaining the full functionality of the IQ or SI, dataloggers can be viewed and downloaded locally at the Remote Hand Station (RHS) instead of gaining access to the actuator. Power for the RHS is supplied by the actuator, removing the need for supplementary power supplies.

The following instructions must be followed and integrated with your safety program when installing and using Rotork products:

- Read and save all instructions prior to installing, operating and servicing this product.
- If you don't understand any of the instructions, contact Rotork for clarification.
- Follow all warnings, cautions and instructions marked on, and supplied with, the product.
- Inform and educate personnel in the proper installation, operation and maintenance of the product.
- Install equipment as specified in Rotork installation instructions and per applicable local and national codes. Connect all products to the proper electrical sources.
- To ensure proper performance, use qualified personnel to install, operate, update and maintain the unit.
- When replacement parts are required, ensure that the qualified service technician uses replacement parts specified by Rotork. Substitutions may result in fire, electrical shock, other hazards, or improper equipment operation.
- Keep all product protective covers in place (except when installing, or when maintenance is being performed by qualified personnel), to prevent electrical shock, personal injury or damage to the product.
- Operation of product in an inappropriate fashion may cause harm or damage to unit or other equipment surroundings.

2 - Health and Safety

This manual has been produced to enable a competent user to install, operate, adjust and inspect the RHS.

The electrical installation, maintenance and use of the RHS should be carried out in accordance with the National Legislation and Statutory Provisions relating to the safe use of this equipment applicable to the site of installation.

For the UK: Electricity at Work Regulations 1989 and the guidance given in the applicable edition of the 'IEE Wiring Regulations' should be applied. Also the user should be fully aware of their duties under the Health and Safety at Work Act 1974.

For the USA: NFPA70, National Electrical Code® is applicable. The mechanical installation should be carried out as outlined in this manual and also in accordance with any relevant national standard codes of practice. If the RHS nameplate indicates that it is suitable for use in Potentially Explosive Atmospheres (Hazardous Areas) then the RHS is suitable for use in Zone 1 and Zone 2 (or Div 1 and Div 2) hazardous area classifications, as defined by the RHS nameplate marking.

For Canada: CEC, Canadian Electrical Code is applicable.

Any equipment connected to the RHS should be of an equivalent (or better) hazardous area certification. The installation, maintenance and use of the RHS installed in a hazardous area must be carried out by a competent person and in accordance with all relevant codes of practice for the particular Hazardous Area certification.

Any inspection or repair of a Hazardous Area approved RHS should not be undertaken unless it conforms to National Legislation and Statutory Provisions relating to the specific Hazardous Area.

Only Rotork approved replacement parts should be used. Under no circumstances should any modification or alteration be carried out on the unit, as this could invalidate the conditions under which its certification was granted.

Access to live electrical conductors is forbidden in a Hazardous Area unless it is done under a special permit to work, otherwise all power should be isolated and the RHS moved to a non-hazardous area for repair or attention.

Only persons competent by virtue of their training or experience should be allowed to install, maintain and repair Rotork equipment. Work undertaken must be carried out in accordance with instructions in the manual. The user and those persons working on this equipment should be familiar with their responsibilities under any statutory provisions relating to the Health and Safety of their workplace.

WARNING: Enclosure Materials

The RHS is manufactured from aluminium alloy with stainless steel fasteners and terminal enclosure fasteners using 12.9 grade high tensile carbon steel.

The cover window is toughened glass which is retained with a 2-part silicone cement.

The user must ensure that the operating environment and any materials surrounding the RHS cannot lead to a reduction in the safe use of, or the protection afforded by, the RHS. Where appropriate the user must ensure the RHS is suitably protected against its operating environment.

3 - Remote Hand Station Mounting

The RHS can be mounted either directly on a wall or to a pole using suitable 'C' brackets. Space should be left around the housing to allow for the fitting of cable glands or conduit. Positioning of the RHS display should be such that easy viewing and operation can be carried out at eye level. Removal of the main display cover is not necessary in order to mount the unit. The only cover that needs to be removed is the terminal housing when cabling to the actuator.

The back housing may be mounted in any position (90° increments) to accommodate different cable / conduit entry requirements. In order to maintain the correct viewing angle of the display, rotate the display cover to suit.

NOTE: Maximum Unit Weight = 9 kg

- 3.1 Locate a suitable place (flat vertical wall or structure) to mount the RHS unit. The display and controls should be accessible and easily viewable.
- 3.2 Mark up a template using the diagrams above. Use a template to mark the wall or structure.
- 3.3 Ensure any work permits are obtained before starting work. Prepare the mounting holes using suitable tools.
- 3.4 Select suitable fixings by referring to the weight above for details of the RHS assembly.
- 3.5 Install the RHS unit to the structure. Tighten the fixings to ensure a secure hold.

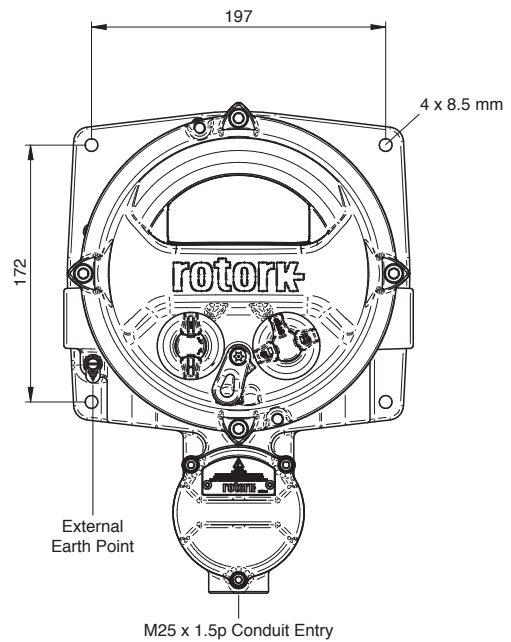
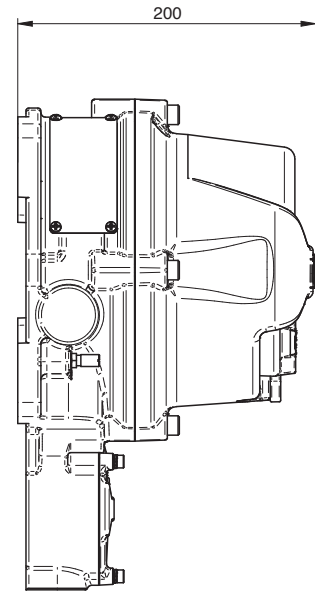

4 - Electrical Connections

The RHS unit is powered by a CAN Bus system installed within Rotork actuators as an option actuator so does not require any supplementary power supply or protection device. The single cable entry is located at the bottom of the terminal housing and is supplied M25 as standard. A thread adaptor can be supplied for other thread sizes including imperial threads.

The interconnecting cable is not supplied. Below is a table of the minimum cable specification for remote mounting up to 50 m and up to 100 m.

No.	PARAMETER	BELDEN CABLE 3084A T5U500 (OR EQUIVALENT) UP TO 100M	MINIMUM SPECIFICATION FOR UP TO 50 M
1	Type of Cable	Twisted pair shielded	Twisted pair shielded
2	No. of Cores	4 (Data pair + Power pair)	4 (Data pair + Power pair)
3	Conductor Material	Tinned Copper	Tinned Copper
4	Core Insulation Material	PVC (power) FPE (data)	PVC
5	Shield Type	Foil + Braid	Braid
6	Shield Coverage	Braid ≥65%	Braid ≥65%
		Foil = 100%	
7	Outer Sheath	PVC	PVC
8	Data Pair Capacitance	≤40 pF/m	≤70 pF/m
9	Conductor Resistance	≤175 Ohm/km (Power)	≤175 Ohm/km
		≤280 Ohm/km (Data)	≤280 Ohm/km (Data)
10	Current Rating	≥1 A	≥1 A

Note: For installation in hazardous areas suitable equivalent cables must be used in accordance with local regulations.

Cable Entry

Only appropriately certified flameproof cable glands or conduit may be used in hazardous locations. The cable entry is tapped M25 x 1.5p. In hazardous locations, only one certified flameproof thread adaptor can be used.

For installation in USA and Canada

Conduit seals must be installed at the enclosure. M25 x 1.5p to either 1/2", 3/4", 1", 1 1/4" or 1 1/2" NPT thread adaptors are factory fitted.

⚠ CAUTION: Wiring may exceed 70 °C in a 70 °C ambient.

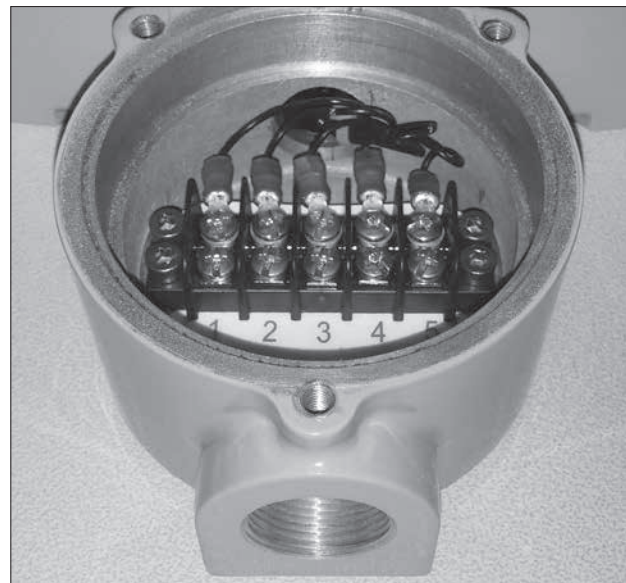

4 - Electrical Connections

Please follow the instructions in section 3 for mounting the RHS before attempting to cable up the unit.

- 4.1 Once the cable specification has been selected, cut to the appropriate length (leaving approx. 200 mm at each end for final termination).
- 4.2 Feed the cable to both the actuator and RHS terminal compartments and secure the glands to ensure watertight integrity is maintained.
- 4.3 Strip back the insulation and braiding so that the inner twisted pair cores are exposed and fit AMP type ring terminal crimps to each wire and shield braid. Insulate the braid to prevent short circuits.
- 4.4 Connect the terminals in each compartment to the correct terminal number by following the wiring diagram supplied.

Earth Ground Connection

A dedicated external earth point is provided for the attachment of a protective earth cable.

ACTUATOR TERMINAL BUNG NO.	RHS TERMINAL BLOCK NO.	FUNCTION
20	1	24 V (V-CUST)
21	2	GND
32	3	CAN H
40	4	CAN L
47	5	SHIELD

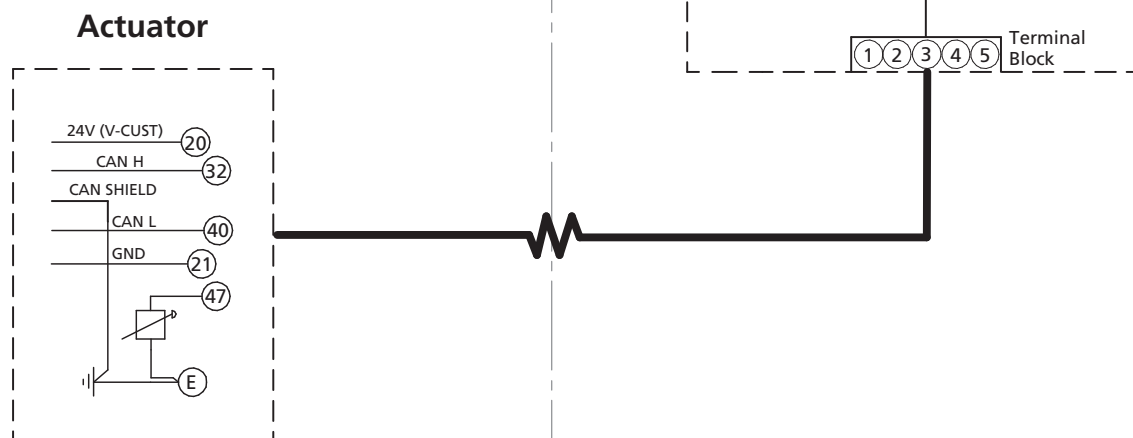

This wiring diagram is for reference only, please refer to the specific actuator wiring diagram supplied with the unit.

5 - Enabling Remote Hand Station Mode on an IQ Range Actuator

NOTE: The following settings are to be carried out at the actuator display only. Settings in section 7 can be carried out at the RHS display.

Please refer to PUB002-040 (IQ range full configuration manual) for the setting menu structure and PUB095-001 (Rotork Bluetooth® Setting Tool *Pro* manual) for instructions on using the Rotork Bluetooth® Setting Tool *Pro*.

5.1 Navigate to the Settings menu

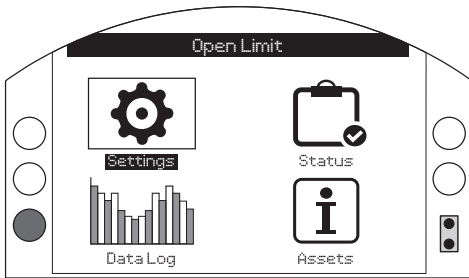

5.2 From the main list, select Control



5.3 Next select Local



5.4 From the Local control menu, navigate to the Remote Hand Station section and highlight 'Enabled'.

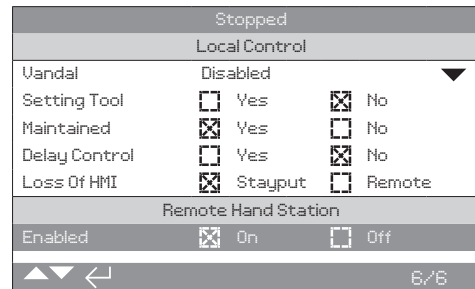

Press (enter ROTACT as the password).

Use or to enable or disable the Remote Hand Station mode.

Once the required mode is checked, press to confirm. The selected mode will be saved and shown as checked on the setting entry.

6 - Enabling Remote Hand Station Mode on an SI Range Actuator

NOTE: The following settings are to be carried out at the actuator display only. Settings in section 7 can be carried out at the RHS display.

Please refer to PUB021-069 (SI range full configuration manual) for the setting structure and PUB095-001 (Rotork Bluetooth® Setting Tool *Pro* manual) for instructions on using the Rotork Bluetooth® Setting Tool *Pro*.

6.1 Navigate to the Settings menu

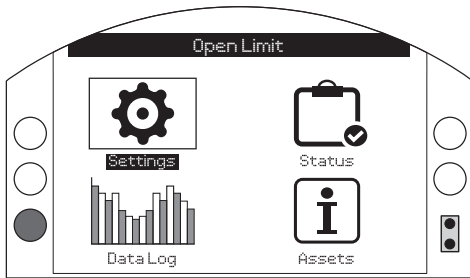

6.2 From the main list, select Control

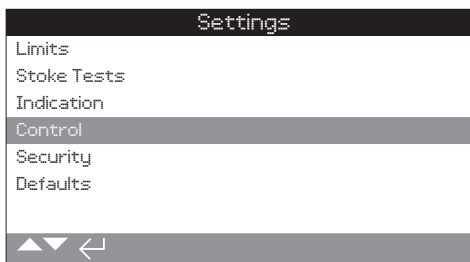

6.3 Next select Local



6.4 From the Local control menu, navigate to the Remote Hand Station section and highlight 'Enabled'.

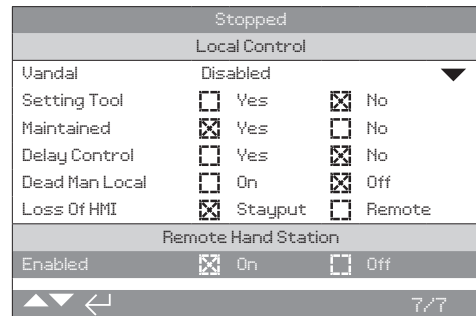

Press **⏏** (enter ROTACT as the password).

Use **⬅** or **➡** to enable or disable the Remote Hand Station mode.

Once the required mode is checked, press **⏏** to confirm. The selected mode will be saved and shown as checked on the setting entry.

7 - Remote Hand Station Settings

NOTE: The following settings can be carried out either at the actuator or at the RHS display.

Setting the Bluetooth Security - The RHS and actuator Bluetooth security can be configured independently.

- 7.1 Navigate to SETTINGS > SECURITY and under the Bluetooth section, choose the level of Bluetooth access required for the actuator.

Press (enter ROTACT as the password).

Use or to select the actuator Bluetooth mode.

Once the required mode is highlighted, press to confirm. The selected mode will be saved and shown as checked on the setting entry.

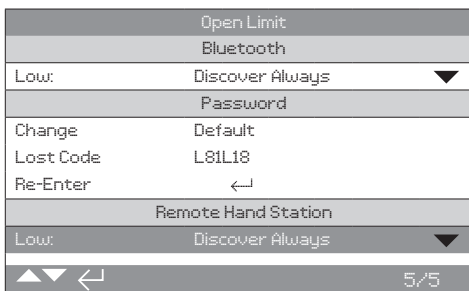

- 7.2 Navigate to SETTINGS > SECURITY and under the Remote Hand Station section, choose the level of Bluetooth access required for the RHS.

Press (enter the password if applicable).

Use or to select the Remote Hand Station Bluetooth mode.

Once the required mode is highlighted, press to confirm. The selected mode will be saved and shown as checked on the setting entry.

Setting the Action on Loss of RHS control - The actuator action can be configured to a particular mode if the RHS were to fail or lose communication with the actuator.

- 7.3 Navigate to SETTINGS > CONTROL > REMOTE HAND STATION and under the Remote Hand Station section select the mode on Loss of HMI.

Press (enter the password if applicable).

Use or to select the Loss of HMI mode.

Once the required mode is highlighted, press to confirm. The selected mode will be saved and shown as checked on the setting entry.

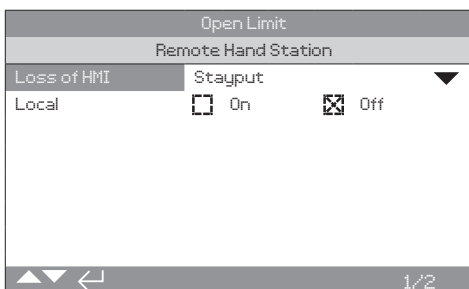

Setting the Local Mode - The Remote Hand Station is intended to work when the actuator is set to Remote Control only, however you can configure the RHS to work when the actuator is set to Local Control. In this case both the RHS and actuator will allow local control, with the last issued command taking preference.

- 7.4 Navigate to SETTINGS > CONTROL > REMOTE HAND STATION and under the Remote Hand Station section select the Local mode.

Press (enter the password if applicable).

Use or to select the Local mode on or off.

Once the required mode is checked, press to confirm. The selected mode will be saved and shown as checked on the setting entry.

7 - Remote Hand Station Settings

Setting the Home Screen Display - The RHS and actuator home screens can be independently configured to show different information.

NOTE: The following setting has to be carried out at the device you are configuring, e.g. at the actuator for the actuator home screen and at the RHS for the RHS home screen.

7.5 IQ Range Settings

Navigate to SETTINGS > INDICATION > LOCAL DISPLAY and under the LCD section select the Home Screen mode from the following four options:

Position only

Torque (analogue) + Position

Torque (digital) + Position

Positioner

Press  (enter the password if applicable).

Use  or  to select the Local mode on or off.

Once the required mode is highlighted, press  to confirm. The selected mode will be saved and shown as checked on the setting entry.

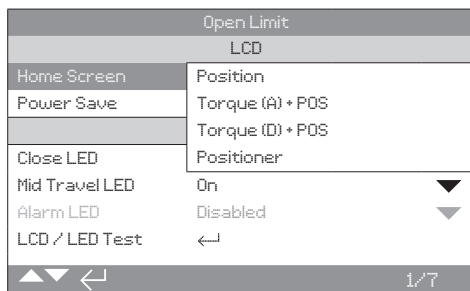

7.6 SI Range Settings

Navigate to SETTINGS > INDICATION > LOCAL DISPLAY and under the LCD section select the Home Screen mode from the following four options:

Position only

Torque (analogue) + Position

Torque (digital) + Position

Positioner

Press  (enter the password if applicable).

Use  or  to select the Local mode on or off.

Once the required mode is highlighted, press  to confirm. The selected mode will be saved and shown as checked on the setting entry.

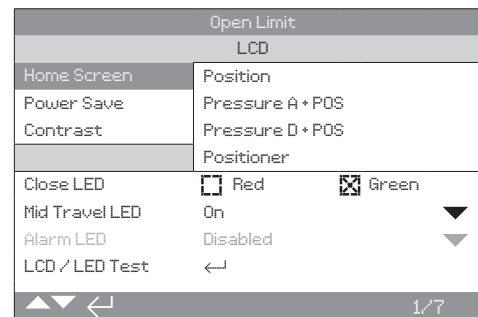

8 - Operating the Remote Hand Station

The Remote Hand Station provides a remote mountable display which allows the operator to monitor and control an actuator mounted in an inaccessible location. All operations which could be performed at the actuator will be duplicated at the Remote Hand Station, including configuration setup, data log download and local control operation.

In order to use the RHS for control, the selectors on both the actuator and RHS have to be set according to the table below:

Functional operation and setup of the actuator via the RHS mimics the actuator's standard operation, refer to publications PUB002-039 (IQ range safe use and installation), PUB021-057 (SI range safe use and installation), PUB002-040 (IQ range full configuration) and PUB021-069 (SI full configuration).

The connected actuator's datalogger can be viewed and extracted via the RHS. For datalogger extraction, please refer to PUB095-001 (Rotork Bluetooth® Setting Tool *Pro* manual).

ACTUATOR SELECTORS (HIGH PRIORITY)	REMOTE HAND STATION SELECTORS	ACTUATOR CONTROL
Local	Local	Actuator*
Local	Remote	Actuator*
Remote	Local	Remote Station
Remote	Remote	Remote control through option cards or hardwired control via terminal block.

* Actuator remains in control unless the Local mode is enabled.
When Local mode enabled, the RHS shares control despite the actuator set for Local Control. Refer to section 7.4

9 - Approvals

Refer to RHS nameplate for unit specific approval details.

European – Hazardous Area

ATEX (2014/34/EU) II 2 GD

Ex db IIB T4 Gb

Ex tb IIIC T120 °C Db T4, IP66 & IP68

Temperature -20 °C to +70 °C (-4 °F to +158 °F)

*Option -30 °C to +70 °C (-22 °F to +158 °F)

*Option -40 °C to +70 °C (-40 °F to +158 °F)

*Option -50 °C to +40 °C (-58 °F to +104 °F)

Ex db IIC T4 Gb T4

Ex tb IIIC T120 °C Db T4, IP66 & IP68

Temperature -20 °C to +70 °C (-4 °F to +158 °F)

*Option -30 °C to +70 °C (-22 °F to +158 °F)

*Option -40 °C to +70 °C (-40 °F to +158 °F)

*Option -50 °C to +40 °C (-58 °F to +104 °F)

International – Hazardous Area

IECEx. IEC60079-0 & IEC600679-1

Ex db IIB T4 Gb

Ex tb IIIC T120 °C Db T4, IP66 & IP68

Temperature -20 °C to +70 °C (-4 °F to +158 °F)

*Option -30 °C to +70 °C (-22 °F to +158 °F)

*Option -40 °C to +70 °C (-40 °F to +158 °F)

*Option -50 °C to +40 °C (-58 °F to +104 °F)

Ex db IIC T4 Gb T4

Ex tb IIIC T120 °C Db T4, IP66 & IP68

Temperature -20 °C to +70 °C (-4 °F to +158 °F)

*Option -30 °C to +70 °C (-22 °F to +158 °F)

*Option -40 °C to +70 °C (-40 °F to +158 °F)

*Option -50 °C to +70 °C (-58 °F to +158 °F)

USA – Hazardous Area

CSAus - Explosionproof to NEC Article 500 (FM3615 & FM3616)

Class I, Division 1, Groups C & D

Class II, Division 1, Groups E, F & G

FM Explosionproof to NEC Article 500

FM3600, FM3615 & FM3616

Temperature -30 °C to +70 °C (-22 °F to +158 °F)

*Option -40 °C to +70 °C (-40 °F to +158 °F)

*Option -50 °C to +40 °C (-58 °F to +104 °F)

Class I, Division 1, Groups B, C & D

Class II, Division 1, Groups E, F & G

Temperature -30 °C to +70 °C (-22 °F to +158 °F)

*Option -40 °C to +70 °C (-40 °F to +158 °F)

*Option -50 °C to +40 °C (-58 °F to +104 °F)

Canada – Hazardous Area

CSA Explosionproof to C22.2 No. 30

CSA Dust explosionproof to C22.2 No. 25

Class I, Division 1, Groups C & D

Class II, Division 1, Groups E, F & G

Temperature -30 °C to +70 °C (-22 °F to +158 °F)

*Option -40 °C to +70 °C (-40 °F to +158 °F)

*Option -50 °C to +40 °C (-58 °F to +104 °F)

Class I, Division 1, Groups B, C & D

Class II, Division 1, Groups E, F & G

Temperature -30 °C to +70 °C (-22 °F to +158 °F)

*Option -40 °C to +70 °C (-40 °F to +158 °F)

*Option -50 °C to +40 °C (-58 °F to +104 °F)

International Non Hazardous

Watertight, BS EN60529

IP66 & IP68, (7 metres for 72 hours)

Temperature -30 °C to +70 °C (-22 °F to +158 °F)

*Option -40 °C to +70 °C (-40 °F to +158 °F)

*Option -50 °C to +40 °C (-58 °F to +104 °F)

US – Non Hazardous

UL50 Enclosure Type 4x & 6

Temperature -30 °C to +70 °C (-22 °F to +158 °F)

*Option -40 °C to +70 °C (-40 °F to +158 °F)

*Option -50 °C to +40 °C (-58 °F to +104 °F)

Canada – Non Hazardous

Enclosure Type 4x & 6 CSA C22.2 No. 94

Temperature -30 °C to +70 °C (-22 °F to +158 °F)

*Option -40 °C to +70 °C (-40 °F to +158 °F)

*Option -50 °C to +40 °C (-58 °F to +104 °F)

Rotork can supply RHS product to national standards not listed above. For details please contact Rotork.

9 - Approvals

Maximum Constructional Flamepath Gaps

Flamepath	Max. Gap (mm)	Min. Length (mm)	Equipment Type
Electrical Cover / Back Housing	0.15	26.00	All Types and Sizes
Terminal Cover / Back Housing ATEX / IECEx	0.15	12.50	RHS
Terminal Cover / Back Housing for FM & CSA	0.115	12.50	RHS
Transfer Loom Bush for FM & CSA	0.115	25.00	RHS
Transfer Loom Bush Flamepath	0.15	25.00	RHS

ATEX / IEC / CSA / Certified RHS

⚠ SPECIAL CONDITIONS

This Remote Hand Station must only be located in areas where the risk of impact to the viewing window is low. This equipment includes some exterior non-metallic paints including the protective coating. To avoid the possibility of static build up, cleaning must only be carried out with a water dampened cloth.

For CAN / CSA C22.2 No. 61010-1-12 compliance the RHS must be connected to a Rotork actuator.

⚠ THREAD DETAILS FOR ATEX AND IECEx APPROVAL

Threaded Flamepath	Thread Size	Thread Length	Equipment Type
Cable Entry	M25x1.5	20.00	All Types and Sizes

⚠ EXTERNAL ENCLOSURE FASTENERS

Enclosure fasteners are stainless steel grade A4-80 M8 for the main display cover and 12.9 M5 for the terminal cover.

Vibration, Shock and Noise

Standard IQ remote hand stations are suitable for applications where vibration and shock severity does not exceed the following:

Type	Level
Plant induced vibration	1g rms total for all vibration within the frequency range of 10 to 1000 Hz
Shock	5g peak acceleration
Seismic	2g acceleration over a frequency range of 1 to 50 Hz if it is to operate during and after the event
Emitted noise	Independent tests have shown that at 1m generated noise does not exceed 65 db(A)

10 - Environmental

End user advice on disposal at end of life of the product

Subject	Definition	Remarks / examples	Hazardous	Recyclable	EU Waste Code	Disposal
Electrical & Electronic Equipment	Printed circuit boards Wire	All Products All Products	Yes Yes	Yes Yes	20 01 35 17 04 10	Use specialist recyclers
Glass	Lens/Window	IQ / SI	No	Yes	16 01 20	Use specialist recyclers
Metals	Aluminium Copper/Brass	Covers Wire	No No	Yes Yes	17 04 02 17 04 01	Use licensed recyclers
Rubber	Seals & O-rings	Cover	Yes	No	16 01 99	May require special treatment before disposal, use specialist waste disposal companies

In all cases check local authority regulation before disposal.

rotork®

Keeping the World Flowing



www.rotork.com

A full listing of our worldwide sales and service network is available on our website.

Rotork plc
Brassmill Lane, Bath, UK
tel +44 (0)1225 733200
fax +44 (0)1225 333467
email mail@rotork.com

Rotork is a corporate member of the Institute of Asset Management



PUB002-059-00
Issue 06/19

As part of a process of on-going product development, Rotork reserves the right to amend and change specifications without prior notice. Published data may be subject to change. For the very latest version release, visit our website at www.rotork.com

The name Rotork is a registered trademark. Rotork recognises all registered trademarks. The Bluetooth® word mark and logos are registered trademarks owned by Bluetooth SIG, Inc. and any use of such marks by Rotork is under license. Published and produced in the UK by Rotork. POWTG0619