

# Rotating Vane Level Switch for Bulk Media



measuring  
•  
monitoring  
•  
analyzing

NIR-9



- Industrial Design
- Aluminum Housing
- Easy Installation
- Different Mounting Options
- Competitive Price
- ATEX Approval
- Adjustable Sensitivity



KOBOLD companies worldwide:

AUSTRALIA, AUSTRIA, BELGIUM, BULGARIA, CANADA, CHINA, CZECHIA, FRANCE, GERMANY, GREAT BRITAIN, HUNGARY, INDIA, INDONESIA, ITALY, MALAYSIA, MEXICO, NETHERLANDS, PERU, POLAND, REPUBLIC OF KOREA, RUSSIA, SPAIN, SWITZERLAND, THAILAND, TUNISIA, TURKEY, USA, VIETNAM

KOBOLD Instruments, Inc.  
1801 Parkway View Drive  
Pittsburgh, PA 15205  
☎ Main Office:  
1.800.998.1020  
1.412.788.4890  
✉ info@koboldusa.com  
www.koboldusa.com

**Description**

The NIR-9 level switch is suitable for a wide variety of applications for bulk material and solids in silos and hoppers. Product level is reliably controlled, regardless of humidity and conductivity of the product. Different vanes and process connections are available, according to product and tank size. During operation, a motor drives a rotating vane on an extended shaft. As soon as the media reaches the rotating vane, its rotation is impeded. The restoring force moves the pivoted motor away from its original position. A micro-switch is actuated, which gives out an alarm signal. A second microswitch turns off the motor. If the filling level decreases, the rotating vane is released again and the force of a spring pulls the motor back to its original position. The motor restarts and the working contact is switched back. The switching sensitivity can be adjusted to three different settings by changing the spring position.

**Technical Details**

- Measuring Principle:** Rotating vane
- Media Temperature:** -4 ... 194 °F  
-4 ... 392 °F (NIR-92)
- Ambient Temperature:** -4 ... 140 °F
- Pressure:** -7.25 ... 7.25 PSIG
- Max. Grain Size:** 1.96"
- Min. Bulk Density:** 2.37 lb/ft<sup>3</sup> (depends on vane and sensitivity) see table below

Rotating Vane Types	High Sensitivity	Mid-Sensitivity	Low Sensitivity
N and R	8.74 lb/ft <sup>3</sup>	11.55 lb/ft <sup>3</sup>	13.36 lb/ft <sup>3</sup>
V	2.37 lb/ft <sup>3</sup>	2.93 lb/ft <sup>3</sup>	3.56 lb/ft <sup>3</sup>
X	2.50 lb/ft <sup>3</sup>	3.12 lb/ft <sup>3</sup>	3.75 lb/ft <sup>3</sup>
A	28.10 lb/ft <sup>3</sup>	34.34 lb/ft <sup>3</sup>	40.58 lb/ft <sup>3</sup>

**Electrical Connection**

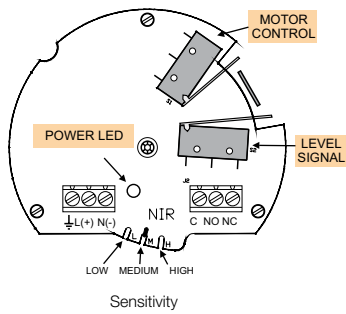

**Applications**

- Cereal
- Flour
- Granulated plastics
- Cement
- Sand
- Coca
- Sugar
- Various bulk materials

**Mounting Examples**

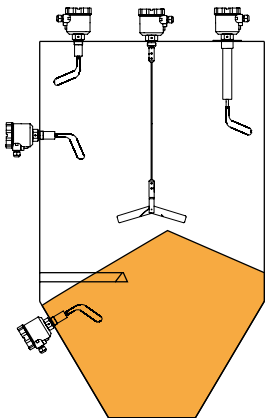

**ATEX Mounting**

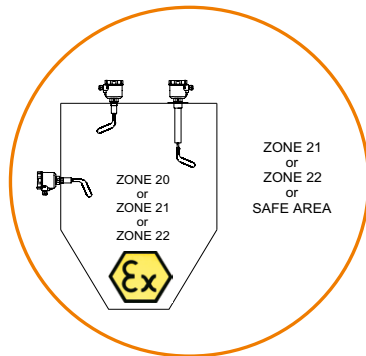

- Sensitivity:** Adjustable, 3 settings
- Rotation Speed:** 5 r.p.m.
- Materials**
  - Housing:** Polyester coated aluminum 360° rotatable
  - Connection, Cable, Extension, Tube, Vane:** Stainless steel, aluminum (see page 4)

**Process Connection (Standard)**

- NIR-910 / E910:** 1" NPT male, 303 stainless steel
- NIR-920 / E920:** 1" NPT male, 303 stainless steel
- NIR-962 / E962:** 1" NPT male, 303 stainless steel
- NIR-95F / E95F:** 1" NPT male, 303 stainless steel
- NIR-930 / E930:** 1½" NPT male, 303 stainless steel

**Other Connections:** 110 mm and 200 mm flanges

**Vane Types:** Standard N, foldable vane V, cruciform vane X, aggregate vane A, reinforced vane R

**ATEX Approval:** II 2/1D Ex t IIIIC T85°C Db/Da

**Power Supply:** 24 VDC or 110 VAC, 50/60 Hz power led

**Power Consumption:** Max. 2 VA

**Electrical Connection:** 2x 1/2" NPT

**Contact:** Micro switch (SPDT)  
max. 250 VAC, 2 A (max 125 VA)

**Protection:** IP 66



Order Details (Example: NIR-910NN640)

Model	Additional Extension	Vane	Fitting	Supply Voltage	Option
Standard Extended Version - 65 mm <b>NIR-91..</b> <b>NIR-E91..</b> (ATEX)	..0.. = no additional extension ..W <sup>2)</sup> .. = Flexible union extension without protection pipe (60" max)	..0.. = Standard ..V.. = Foldable ..X.. = Cruciform (only with F2 connection)	..N6.. = 1" NPT ..N8.. = 1 1/2" NPT (via G1 adapter) ..G6.. = G1 ..G8.. = G1 1/2 (via G1 adapter)	..0.. = 230 V <sub>AC</sub> ..4.. = 110 V <sub>AC</sub> ..3.. = 24 V <sub>DC</sub>	..0 = Without ..Y = Special
Standard Extended Version - 65 mm High Temperature (t <sub>max</sub> : 392 °F) <b>NIR-92..</b> <b>NIR-E92..</b> (ATEX)	..L <sup>1)2)</sup> .. = extension with protection pipe (156" max)				
Standard Extended Version - 200 mm Reinforced for Side Mount <b>NIR-96..</b> <b>NIR-E96..</b> (ATEX)	..2.. = no additional extension		..F1.. = Flange 110 mm (via G1 adapter) ..F2.. = Flange 200 mm (via G1 adapter)		
Flexible Cable Version - Top Mount <b>NIR-95..</b> <b>NIR-E95..</b> (ATEX)	..F <sup>2)</sup> .. = Flexible Cable (390" max)	..V.. = Foldable ..X.. = Cruciform (only with F2 connection)			
Heavy Duty Version <b>NIR-93..</b> <b>NIR-E93..</b> (ATEX)	..0.. = no additional extension	..R.. = Reinforced ..X.. = Aggregate	..N8.. = 1 1/2" NPT ..G8.. = G1 1/2 ..F3.. = Flange 110 mm (via G1 1/2 adapter)		

1) Only available with N8, G8, F1, or F2 fitting options 2) Clearly specify length when ordering

Dimensions (mm)

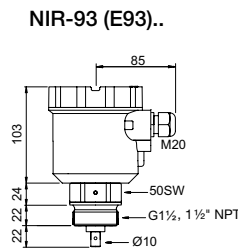
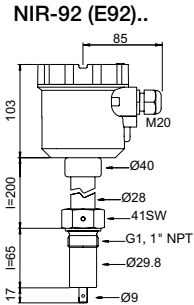
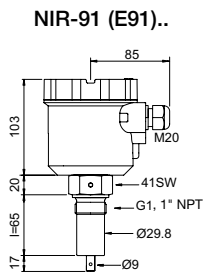

NIR-95F (E95F)..

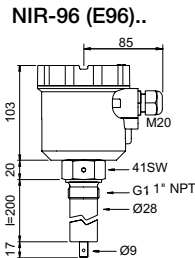
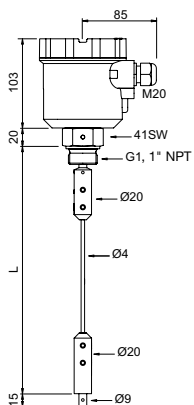

NIR-91 (E91)..

NIR-92 (E92)..

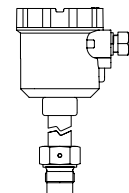
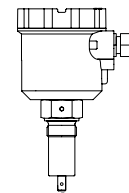

Additional Extension ..W & ..L via G1 Adapter Connections

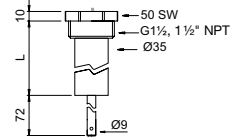
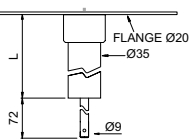
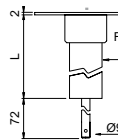
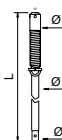

Order Details: Accesories / Spare Parts (Example: **NMZ-AF30**)

Model		Option
NMZ-	..A.. = Process Connections	..N8.. = 1½" NPT male, 303 stainless steel, x G1 female ..N70.. = 1¼" NPT male, 303 stainless steel, x G1 female ..G8.. = G1½ male, 303 stainless steel, x G1 female ..F1.. = Flange, 303 stainless steel, Ø 110 mm x G1 female ..F2.. = Flange, 303 stainless steel, Ø 200 mm x G1 female ..F3.. = Reinforced flange, 304, Ø 110 mm x G1½ female ..S6.. = Welding sleeve, 316L stainless steel x G1 female
	..D.. = Type of Vane	..N0.. = Standard, 303 stainless steel ..V0.. = Foldable, 303 stainless steel ..X0.. = Cruciform, 303 stainless steel ..R0.. = Reinforced, 303 stainless steel ..A0.. = Aggregate, 303 stainless steel
	..E <sup>2)</sup> .. = Extensions	..LN8.. = Protection pipe, 304 stainless steel, 1½" NPT x G1 ..LG8.. = Protection pipe, 304 stainless steel, G1½ x G1 ..L1.. = Protection pipe, with F1 flange, 304 stainless steel x G1 ..L2.. = Protection pipe, with F2 flange, 304 stainless steel x G1 ..W1.. = Without protection pipe, and flexible union, 304 stainless steel ..F1.. = Flexible cable Ø 4 mm, 303 stainless steel
		..0 = Without ..Y = Special

<sup>2)</sup> Clearly specify length when ordering

Type of Vane

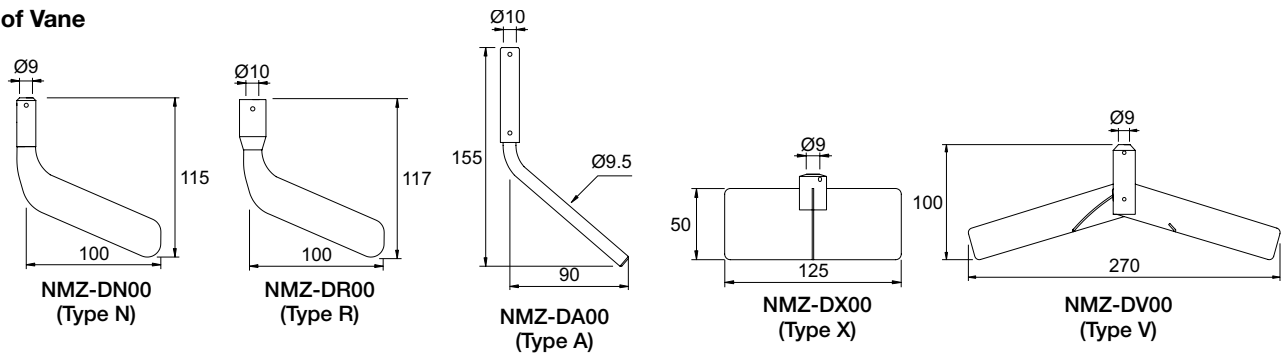

Process Connections

