



Q108-0000



ACTIONI/Q[®] Q108 DC Powered DC Input Limit Alarm

Provides Relay Contact Closures
at a Preset DC Input Level



- Field Configurable Input Ranges
- TouchCAL™ Technology
- Setpoints Programmable HI or LO and Failsafe or Non-Failsafe
- High Density DIN Rail Mounting
- Flexible 9 to 30VDC Power Supply
- 24VDC Transducer Excitation
- SnapLoc™ Plug-in Terminals
- ASIC Technology

Description

The ActionI/Q model Q108 is a DIN rail mount, DC voltage or current input limit alarm with dual setpoints and two contact closure outputs. The field configurable input and alarm functions offer flexible setpoint capability. Input voltage spans from 10mV to 200V and input current spans from 1mA to 100mA can be field configured. Bipolar inputs are also accepted.

The Q108 is configurable as a single or dual setpoint alarm, with HI or LO trips and failsafe or non-failsafe operation. Also included are adjustable deadbands (up to 100% of full scale input) for each setpoint, a 24VDC voltage source (isolated from line power) for transducer excitation, and a universal DC power supply which accepts any voltage between 9 and 30VDC.

TouchCAL Technology

Action has simplified setpoint calibration. Using a pushbutton instead of potentiometers, improvements in calibration resolution and reliability are realized due to the elimination of the potentiometers' mechanical variability.

For calibration, simply input the signal level of the desired trip and press the pushbutton to store it in non-volatile memory. Deadband is entered the same way with another pushbutton press to store.

Diagnostic LEDs

The Q108 is equipped with three front panel LEDs. The green LED is a dual function LED labeled IN, which indicates line power and input signal status. Active DC power is indicated by the illuminated LED. If this LED is off, check DC power and wiring connections. If the input signal is 10% above or below the configured input range the green LED will flash at 8Hz or 4Hz, respectively.

The two red LEDs indicate the relay state of each setpoint. An illuminated red LED indicates the tripped condition for the respective setpoint.

Output

The Q108 is equipped with two SPDT (form C) relays, rated at 120VAC or 28VDC at 5 amperes. Each of these relays is independently controlled by the field configurable setpoint and deadband.

Operation

The Q108 limit alarm setpoints can be configured for HI or LO, failsafe or non-failsafe operation. Each of the setpoints has a respective HI or LO deadband. In a tripped condition, the setpoint is exceeded and the appropriate red LED will illuminate. The trip will reset only after the process falls below the HI deadband or rises above the low deadband (see Figure 1). For proper deadband operation, the HI setpoint must be set above the LO setpoint. In failsafe operation, the relay is energized when the process is below the HI setpoint or above the LO setpoint (opposite for non-failsafe). In the failsafe mode, a power failure results in an alarm state output.

Dynamic Deadband

Circuitry in the Q108 prevents false trips by repeatedly sampling the input. The input must be beyond the setpoint for 100 milliseconds, uninterrupted, to qualify as a valid trip condition. Likewise, the input must fall outside the deadband and remain there for 100 milliseconds to return the alarm to an untripped condition. This results in a "dynamic deadband" —based on time— in addition to the normal deadband.

Configuration

Unless otherwise specified, the factory presets the Model Q108 as follows:

Input:	Current
Range:	0-20mA
Output:	Dual, SPDT
Trip:	A: HI; B: LO
Failsafe:	No
Deadband:	A, B: 0.25%

The DC power input accepts any DC source between 9 and 30VDC.

Note: An I/QRail is an optional accessory to power the modules. A 2, 4, or 8 position rail is available. See ordering information.

For other I/O ranges, refer to Table 1 and Figure 5. Reconfigure switch SW1 for the desired input type, range and function.

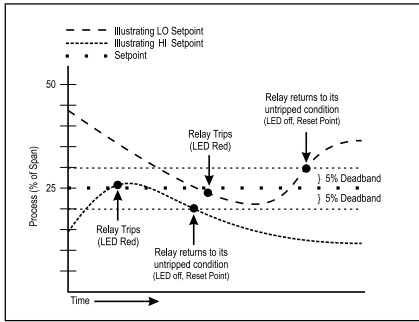

Figure 1: Limit alarm operation and effect of deadband.

WARNING: Do not change switch settings with power applied. Severe damage will result!

1. With the module removed from the rail and not powered, snap off the face plate by lifting the right edge away from the heat sink. Note the input switch (SW1) is located under the faceplate. Set positions 9 & 10 for voltage or current input (see Table 1).
2. Set positions 1 through 4 of "SW1" for the desired input range (see Table 1).
3. Set position 5 of "SW1" to ON (closed) for unipolar (e.g., zero based, 0-20mA) range or OFF (open) for bipolar (e.g., -100% offset, -20 to 20mA) range (see Figure 5).
4. Set positions 6 and 7 "SW1" to ON for a HI trip setpoint or OFF for a LO trip setpoint (see Figure 5).
5. Set position 8 of "SW1" to ON for non-failsafe operation or OFF for failsafe operation (e.g., alarm trips upon power failure).

Calibration

1. After configuring the DIP switches, connect the input to a calibrated DC source and apply power. Refer to the terminal wiring in the specifications section.

Note: For best results, calibration should be performed in the operating environment, mounted on a DIN rail, allowing at least one hour for thermal equilibrium of the system.

2. After applying power to the unit all three LEDs will flash for approximately 10 seconds. Adjust the input signal level for the Relay "A" setpoint. The green LED should be on. Press and hold the CAL button for 4 seconds (until the red LED starts flashing) to enter the calibration mode. The green LED will be on and the red Relay "A" LED will be flashing.

Note: If the green LED is flashing, the input is out of range (i.e. 7 % above or below the configured range). Check to make sure the input signal is within the DIP switch configuration range. Double check the DIP switch settings.

3. Setpoint "A": Input the desired trip level for Relay "A" and push the CAL button. The green LED and the red Relay "A" LED will be flashing. Note that the green LED will stop flashing when the input drops below a high setpoint or rises above a low setpoint.

4. Deadband "A": For minimum deadband (approximately 0.25%), press and hold the CAL button for 4 seconds. For high setpoints, lower the input level to the desired deadband point and push the

CAL button. For low setpoints, increase the input level (green LED turns off) to the desired deadband level and push the CAL button. The green LED will be on and the red Relay "B" LED will be flashing.

5. Setpoint "B": Input the desired trip level for Relay "B" and push the CAL button. The green and the red Relay "B" LED will be flashing. Note that the green LED will stop flashing when the input drops below a high setpoint or rises above a low setpoint.

6. Deadband "B": For minimum deadband (approximately 0.25%), press and hold the CAL button for 4 seconds. For high setpoints, lower the input level (green LED turns off) to the desired deadband point and push the CAL button. For low setpoints, increase the input level to the desired deadband level and push the CAL button. The green LED will be on and both the red LEDs will be flashing.

7. Press the CAL button once again to exit the calibration mode. Check the setpoint and deadband to validate calibration.

Relay Protection and EMI Suppression

When switching inductive loads, maximum relay life and transient EMI suppression is achieved by using external protection (see Figures 2 and 3). Place all protection devices directly across the load and minimize lead lengths. For AC inductive loads, place a properly rated MOV across the load in parallel with a series RC snubber. Use a 0.01 to 0.1mF pulse film capacitor (foil polypropylene recommended) of sufficient voltage, and a 47 ohm, 1/2W carbon resistor. For DC inductive loads, place a diode across the load (PRV > DC supply, 1N4006 recommended) with (+) to cathode and (-) to anode (the RC snubber is an optional enhancement).

Table 1: Q108 Input Range Switch

Voltage	Current	Input Range Selector SW1			
		1	2	3	4
10 mV	1 mA			■	
20 mV	2 mA			■	■
50 mV	5 mA		■		
100 mV	10 mA		■		■
200 mV	20 mA		■	■	
500 mV	50 mA		■	■	■
1V	100 mA	■			
2V		■			■
5V		■		■	
10V		■		■	■
20V		■	■		
50V		■	■		■
100V		■	■	■	
200V		■	■	■	■

Key: ■ = 1 = ON or Closed

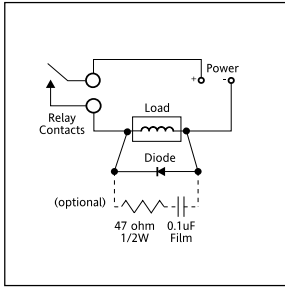

Figure 2: DC Inductive Loads

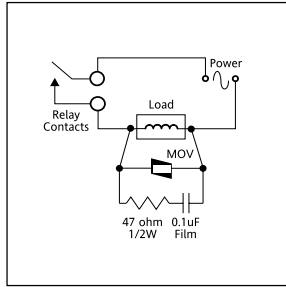

Figure 3: AC Inductive Loads

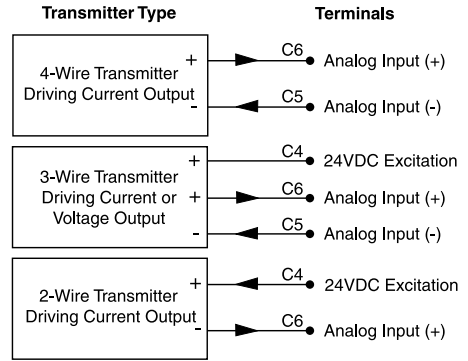
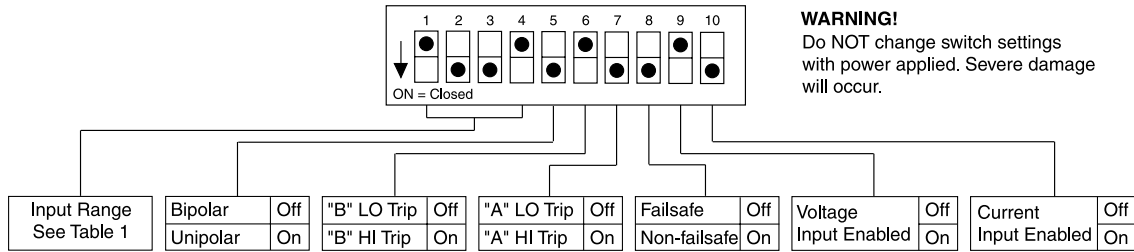

Figure 4: Typical Connections for Voltage or Current for Q108



WARNING!
Do NOT change switch settings with power applied. Severe damage will occur.

Figure 5: Q108 Input Range/Function Selection (SW1) Factory Default Settings
Note: For voltage inputs Current Enable must be off. For current inputs Voltage Enable must be off.

Note:
1. During normal operation, the green LED will be ON or flashing. The Red LEDs will be ON while the relative relay is tripped.
2. In the calibration mode, if no button is pushed within 2 minutes, the unit will revert to normal operation.

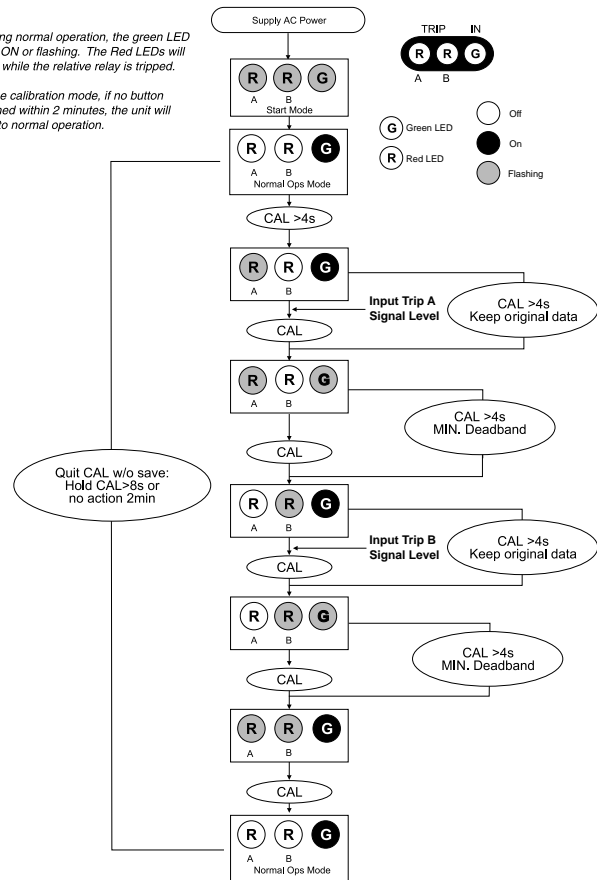

Figure 6: Q108 Calibration Flow Chart

Specifications

Inputs:

Voltage Input:

Range: 10mV to $\pm 200V$; Impedance: $>100k$ ohms
Overvoltage: 200V rms, max.

Current Input:

Range: 1mA to $\pm 100mA$; Impedance: 20 ohms, typical
Overcurrent: 170mA rms, max.
Overvoltage: 60VDC (protected by self resetting fuse)

Common Mode (Input to Ground): 1800VDC, max.

LED Indicators:

Input Range (Green)
>110% input: 8Hz flash
<10% input: 4Hz flash
Setpoint (Red)
Tripped: Solid red
Safe: Off

Limit Differential (Deadband):

>50mV/5mA: 0.25% to 100% of span
<50mV/5mA: 1% to 100% of span

Response Time:

Dynamic Deadband:
Relay status will change when proper setpoint/process condition exists for 100msec.
Normal Mode (analog filtering): <250mSec (10-90%)

Setpoints:

Effectivity: Setpoints are adjustable over 100% of selected input span.
Repeatability (constant temp.):
>50mV/5mA: 0.1% of full scale
<50mV/5mA: 0.2% of full scale

Temperature Stability: $\pm 0.05\%$ of full scale/ $^{\circ}C$, max.

Excitation Voltage: 24VDC, 20mA, maximum

Ordering Information

Models & Accessories

Specify (model number)

- 1) **Q108-0000**
- 2) Specify I/QRail type and quantity (optional)
- 3) Accessories: (see Accessories)
- 4) Optional Custom Factory Calibration: Specify **C620** with desired input, setpoint and deadband.

Accessories

ActionI/Q series modules mount on standard TS32 (model MD02) or TS35 (model MD03) DIN rail. In addition, the following accessories are available:

MD02	TS32 DIN rail
MD03	TS35 x 7.5 DIN rail
WV905	24VDC Power Supply (500mA)
H910	24VDC Power Supply (1 Amp)
H915	24VDC Power Supply (2.3 Amp)
IQRL-2002	2 Position I/QRail & DIN rail
IQRL-2004	4 Position I/QRail & DIN rail
IQRL-2008	8 Position I/QRail & DIN rail

Common Mode Rejection: DC to 60Hz: 120dB

Isolation: 1800VDC between contacts, input and power

ESD & Transient Susceptibility: Meets IEC 801-2, Level 3 (8KV)

Humidity (Non-Condensing):

Operating: 15 to 95% @45 $^{\circ}C$
Soak: 90% for 24 hours @65 $^{\circ}C$

Temperature Range:

Operating: 0 to 55 $^{\circ}C$ (32 to 131 $^{\circ}F$)
Storage: -25 to 70 $^{\circ}C$ (-13 to 158 $^{\circ}F$)

Power: 2.5W max., 9 to 30VDC

Relay Contacts

2 SPDT (2 form C) Relays; 1 Relay per setpoint
Current Rating (resistive)

120VAC: 5A; 240VAC: 2A; 28VDC: 5A

Material: Gold flash over silver alloy

Electrical Life: 10^5 operations at rated load

Note: External relay contact protection is required for use with inductive loads.

Mechanical Life: 10^7 operations

Wire Terminations: Screw terminations for 12-22 AWG

Weight: 0.56lbs.

Agency Approvals

UL recognized per standard UL508 (File No. E99775).

CSA certified per C22.2 No. 0-M91 & 142-M1987 (File No. LR42272-84).

Terminal	Connection	Terminal	Connection
A1	Relay A, N.O.	C3	Relay B, N.C.
A2	Relay A, Common	C4	Voltage Supply (+24VDC)
A3	Relay A, N.C.	C5	Input (-)
A4	Not Connected	C6	Input (+)
A5	DC Power (+)	P1	Not Used
A6	DC Power (-)	P2	Not Used
C1	Relay B, N.O.	P3	DC Power (+)
C2	Relay B, Common	P4	DC Power (-)

Dimensions

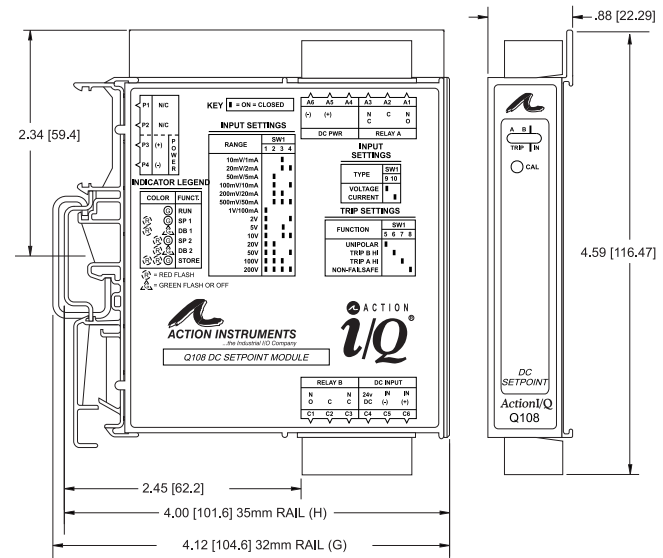

Eurotherm

by **Schneider Electric**



Printed on recycled paper

Schneider Electric Systems USA, Inc.

44621 Guilford Drive, Suite 100

Ashburn, VA 20147

703-724-7300

info.eurotherm.us@schneider-electric.com

www.eurotherm.com

Factory Assistance

For additional information on calibration, operation and installation contact our Technical Services Group:

703-724-7314

US.Support@schneider-electric.com

721-0717-00-H 09/06 Copyright© Eurotherm, Inc 2006