

PD4-6620 Loop Leader+ Loop-Powered Flow Rate/Totalizers

Data Sheet



PD4-6624/8
Flow Rate/Totalizer with Bargraph

Loop Leader+
Series



All models



IECEx

PD4-6628 only

- Large Display NEMA 4X, IP65 Loop-Powered Wall & Pipe Mounted Flow Rate/Totalizers
- 4-20 mA Input Displayed with $\pm 0.02\%$ Accuracy
- 2.1 Volt Drop Maximum
- 2.8" (71 mm) 5 Alphanumeric 14-Segment Characters Top Display
- 1.5" (39 mm) 8 Alphanumeric 14-Segment Characters Bottom Display
- 20-Segment Bargraph with Numeric Percent Indication
- 8-Digit Total & Grand Total Display, Up to 13 Digits Using Both Lines
- Display Rate & Total Simultaneously
- Automatic or Manual Batch Control
- Display Open Channel Flow with Programmable Exponent Feature
- 32-Point Linearization & Square Root Extraction
- (2) Open Collector Outputs Standard; Assignable to Pulse, Alarm, Timer, or Stopwatch
- (2) Optional Loop-Powered Solid-State Relays; Assignable to Alarm, Sample, Timer, Batch, or Stopwatch
- Stopwatch & Timer Functions to Drive Relays & Open Collectors
- Optional Isolated 4-20 mA Analog Output
- Display Relay Runtime & Cycle Count via Relay Info Menu
- Free PC-Based MeterView XL USB Programming Software
- Externally DC Powered Backlight with Red Backlight for Alarm Conditions
- Safe Area Operating Temperature Range: -40 to 75°C (-40 to 167°F)
- Conformal Coated PCBs for Dust & Humidity Protection
- ATEX and IECEx Certified as Intrinsically Safe (PD4-6628 Only)
- Pipe Mounting Kit Available
- 3-Year Warranty

Watch the Loop-Powered
Meters Video



Click or scan

VIDEO



The Most Comprehensive Line of Loop-Powered Indicators on the Market

Precision Digital is broadening its line of loop-powered indicators to include three new product lines:

- PD6900 ProtEX+ Explosion-Proof Meters
- PD6900 VantageView+ General Purpose Field-Mount Meters
- PD4 Loop Leader+ Large Display Field-Mount Loop-Powered Meters

Learn all about these new series and see why Precision Digital now has the most complete line of loop-powered meters on the market!



Watch the Loop-Powered Meters Video
Click or scan

TABLE OF CONTENTS

OVERVIEW 3

DISPLAY FEATURES 4

OUTPUTS 8

BATCH CONTROL 9

TOTALIZER CAPABILITIES 12

INPUT SIGNAL CONDITIONING 13

PHYSICAL FEATURES 14

OPERATIONAL FEATURES 15

METERVIEW XL PROGRAMMING SOFTWARE 17

ACCESSORIES 19

LIGHT / HORN & BUTTON ACCESSORY 21

DIMENSIONS 24

CONNECTIONS 25

WIRING DIAGRAMS 26

SPECIFICATIONS 27

ORDERING INFORMATION 30

WHY USE LOOP-POWERED METERS?

The most basic decision a user wishing to display a 4-20 mA signal on a digital display has to make is: should the meter be powered by line voltage or should it be powered by the 4-20 mA loop? The meters in this data sheet are powered by the 4-20 mA loop. The three main benefits of this are:

- No additional power required
- Easy wiring
- Additional digital displays can easily be added in the same loop

The diagram on the right illustrates how a loop-powered meter is wired. Notice there are only two connections made to the meter.

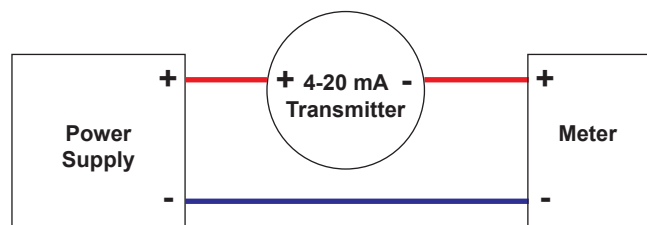

For more information on loop-powered meters, check out these white papers:

[Fundamentals of Loop-Powered Devices](#)

[Loop-Powered vs Line-Powered Meters](#)

OVERVIEW

Front



PD4-6624/8 Flow Rate/Totalizer

- 5-Digit alphanumeric top line
- 8-Digit alphanumeric bottom line
- 20-Segment bargraph with numeric percentage

Connections

- (2) Open Collector Outputs Standard (150 mA max); Assignable to Pulse, Alarm, Timer, or Stopwatch
- Digital Input for Remote Operation of a Single Task
- (2) Optional Loop-Powered Solid-State Relays; Assignable to Alarm, Control, Timer, or Stopwatch
- Optional Isolated 4-20 mA Analog Output
- Remote Contacts for Remote Operation of All Four Programming / Operation Buttons Using Control Station [PDA2364-MRUE](#)
- Remote Contacts for Remote Operation of Buttons for Batch Control Applications Using Control Station [PDA2364-MSBS](#)

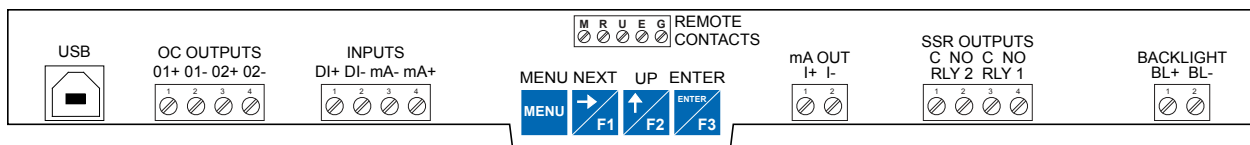

Connections for -L5N Option

Loop-Powered Flow Rate/Totalizers with Advanced Display and Control Features

The Loop Leader+ loop-powered large display flow rate/totalizers can be installed virtually anywhere to provide convenient and informative display of any 4-20 mA signal. One of the most convenient features of these instruments is their large, dual-line display which is typically used to display flow rate on the 2.8" 5-character alphanumeric top display and flow total, flow grand total, or a tag on the 1.5" 8-character alphanumeric bottom display. Both display lines use 14-segment, alphanumeric characters that provide much clearer indication of tags, units, or alarm messages than 7-segment characters do.

Further enhancing the display on these instruments is a 20-segment bargraph that also includes a numeric value of the percentage the bargraph represents.

Free, PC-based, MeterView XL software that connects to the meter via a micro USB cable is available for programming and setup of the meters.

The PD4 is available in two configurations: Display only and with two solid-state relays and 4-20 mA analog output. All models come equipped with two open collector outputs and remote contacts. The open collector outputs are useful for alarm indication or pulse output. The remote contacts can be used to remotely operate the four programming buttons, to reset the total, to start/stop a timer/stopwatch, and more. The relays can be programmed for alarm indication, sample, timer, batch control, or stopwatch.

Finally, the PD4-6628 is an intrinsically safe version that can be installed in hazardous areas.

DISPLAY FEATURES

PD4-6624/8 Flow Rate/Totalizer with Bargraph



Display Flow Rate & Total at the Same Time

One of the key features of the Loop Leader+ rate/totalizers is their ability to display flow rate and total at the same time. In addition, the meter can toggle between the rate and total and their corresponding units as the following illustrates.

Display Flow Rate & Total and Toggle Between Units



Wide Variety of Display Capabilities

In addition to the most common setup of flow rate on the top line and flow total on the bottom line, these meters can be set up for a variety of display configurations.

Display Flow Rate and Toggle Between Units & Tag

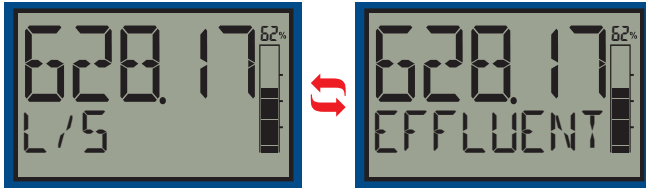

Flow Rate on Top
Rate Units on Bottom

Flow Rate on Top
Tag on Bottom

Display Flow Total and Toggle Between Units & Tag

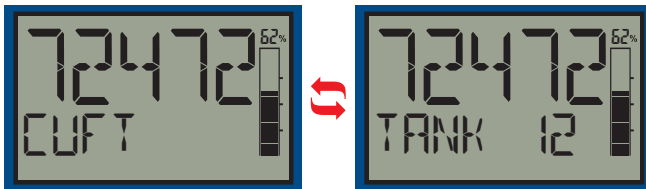

Total Flow on Top
Total Units on Bottom

Total Flow on Top
Tag on Bottom

Display Flow Total & Flow Grand Total and Toggle Between Units

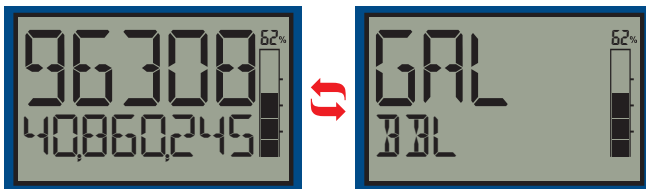

Total Flow on Top
Grand Total Flow on Bottom

Total Units on Top
Grand Total Units on Bottom
(note different units than Total)

The following table shows the items that can be displayed on the Top and Bottom lines:

Top (TOP) Line Can Display	
Off (Blank)	Preset batch value
Rate	Stopwatch
Rate and its units alternating	Timers OC and relays
Total	Min
Total and its units alternating	Max
Tag	Min & max
Units	
Bottom (BOTTOM) Line Can Display	
Off (Blank)	Tag
Total (with units or tag alternating)	Total, its units, and the rate and units alternating
Grand total (with units or tag alternating)	Grand total, units, and rate units alternating
Rate (with units or tag alternating)	Rate's percentage of max scale
Rate and the total's units alternating	Rate or total units
mA input value	mA output value
Units for value on top line	Preset batch value
Tag and total units alternating	Tag and rate units alternating
Alarm Message	

14-Segment Characters

Notice how much better characters like “/” and “m” appear as 14-segment characters on the bottom display vs. 7-segment characters found on other meters.



7-Segment



14-Segment

Dual-Scale Display Feature

Users can use the Loop Leader+ dual-scale feature when they want to show the same input in two different scales. For instance, the following example shows an application where the Loop Leader+ displays the input in gallons per minute and cubic feet per minute.

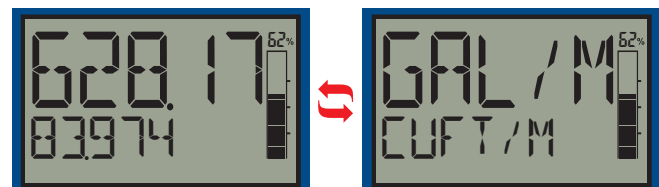

Rate in GPM on Top
Rate in CFM on Bottom

GPM Units on Top
CFM Units on Bottom

Large Informative Display

One of the most convenient features of the PD4 Loop Leader+ Series is its large, dual line display. With a whopping digit height of 2.8" (71 mm) on the top display, the Loop Leader+ has the largest digits for any loop-powered meter on the market! Even the 1.5" (39 mm) 8-character alphanumeric bottom display is bigger than most loop-powered large displays on the market. Plus, the 20-segment bargraph with percentage indication on top makes reading and understanding process values easier than ever. Predefined display units give users even more display flexibility, and the high contrast 24 VDC externally powered backlit LCD display is readable from far away and under various lighting conditions.

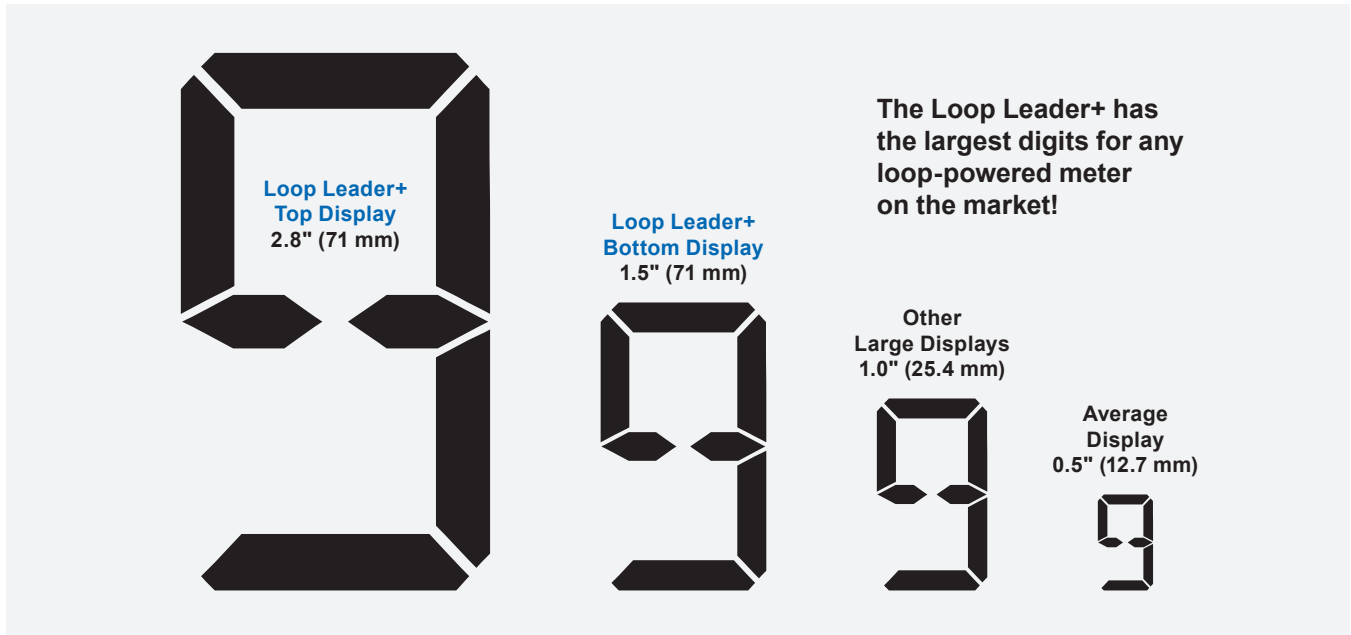

Commas Make it Easy to Read Big Numbers

The bottom display is set to show a comma separating the thousands and millions place by default if a numeric value is being displayed. This feature can be disabled or enabled using the *Comma* menu.



Red, Flashing Display Gets People's Attention When Alarms Occur

When an alarm occurs, the display can be programmed to turn red and flash. In addition, a unique custom alarm message for each of the two relays and two open collectors can be displayed on the bottom display. These features can be activated even if no relay or open collector is connected.

Showing Red Backlight for Alarm Indication Programmable Flashing Display

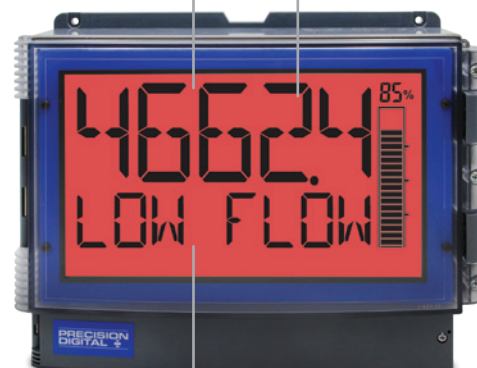

Toggle Between Units & Custom Alarm Message

Backlight Turns Red on Alarm

The externally DC powered backlight is standard on all Loop Leader+ meters. It provides optimum visibility in any lighting condition and it can be programmed to turn red for alarm conditions. The backlight may be enabled or disabled using the *Backlight* menu. The backlight is enabled by default (input must be wired appropriately for the backlight to function). The backlight must be powered by an external power source.



Backlight for Visibility in Any Lighting Condition and Red Backlight for Alarm Indication

Bargraph Provides Quick Understanding

The 20-segment bargraph helps users get a quick understanding of where their process is at. This bargraph also includes a numeric value of the percentage the bargraph represents. The bargraph can be programmed to represent either rate, a percentage of the rate, total, or it can be disabled.



Bargraph indicating rate in gallons/minute

Max/Min Display

The max & min readings (peak & valley) reached by the process can be displayed either continuously or momentarily.

- Display momentarily by pressing the F1 function key (default) or assigning to any of the other function keys or to the digital input in the User menu. Press Enter to lock/unlock max/min display.
- Display continuously by assigning either display line to max/min through the Display menu.

Any of the F1-F3 function keys (buttons) and the digital input can be programmed to reset the max & min readings.

Top Display: Process Value
Bottom Display: Max & Min

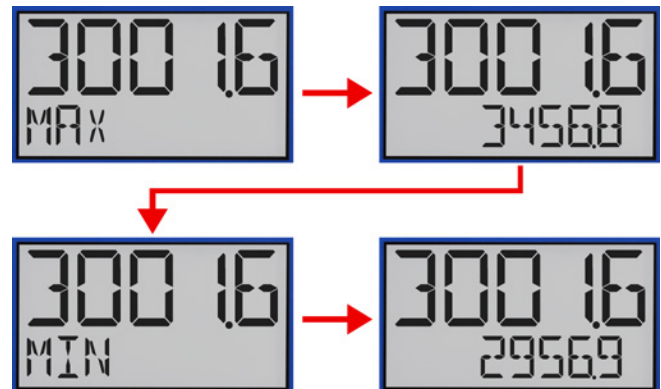

Using 13 Digits to Display Total

The top and bottom displays can be setup to display a 13-digit total (9,999,999,999,999). The total will roll over to zero when it exceeds the limit.



Predefined and Custom Units

The meter has the most common predefined rate and volume units. If the desired unit is not available, the user can program a custom unit.

Total & Rate in Different Units

The user can select to display total in different units than the rate. For instance, a customer could measure flow rate in gallons per minute and total in acre-feet by simply selecting AF (acre-feet) units for the total. Additionally the user can enter a custom unit and conversion factor to display the total in any unit of measure.

OUTPUTS

Loop Leader+ meters come with two open collector outputs as standard and two solid-state relays and 4-20 mA output as options. The open collector outputs and relays generally operate in the same manner, with the major exception being the open collectors are not available for batch control and the relays are not available with pulse output features. The open collectors and relays can be controlled either automatically or manually. The alarm status (with a unique flashing red message for each of the two relays and open collectors) will show on the display even with no output wired.

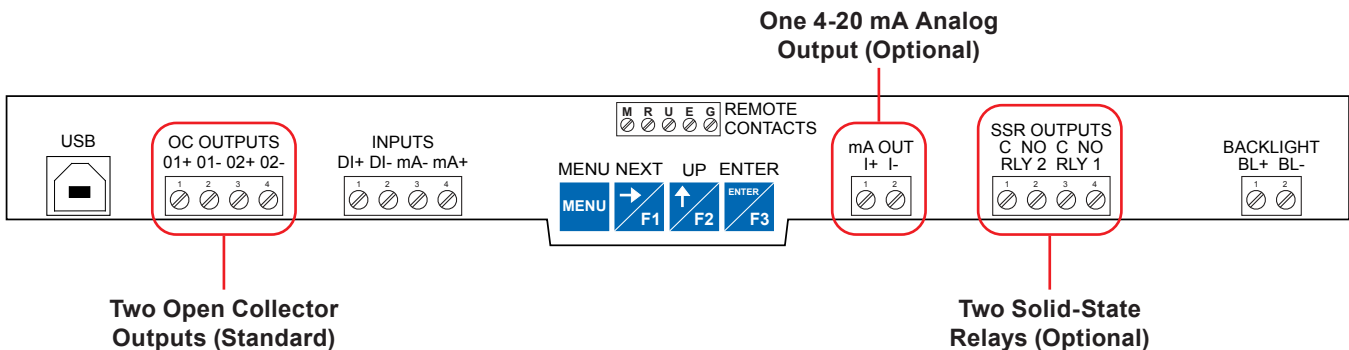

Two Open Collector Outputs

The meter is equipped with two NPN open collector outputs that may be set up for pulse outputs, alarms, timed pulses, stopwatch on/off, or disabled. Pulse outputs can be set to transmit the rate, total or grand total. Output 2 may be used to generate a quadrature output based on the other open collector output. An output test mode is also selectable to generate pulses at a constant programmable frequency. The open collectors are commonly used to generate a pulse for every user-defined amount of flow that has been generated. For instance, the Loop Leader+ can be programmed to generate a pulse for every 100 gallons of flow.

Two Optional Solid-State Relays

The meter is optionally equipped with two solid-state relays that may be set up for alarms, sample, timer, batch control, or stopwatch. The relays are rated at 250 VAC/DC @ 1 A for resistive loads and 75 VA @ 0.6 A, 250 VAC/DC max (Safe Area only) for inductive loads. Alarms are available based on the PV value or the digital input.

Optional Isolated 4-20 mA Output

The isolated analog output signal can be configured to represent the rate, total or to retransmit the 4-20 mA input signal without the need to scale the output. While the output is nominally 4-20 mA, the signal will accurately accommodate under- and over-ranges from 1 to 23 mA. The output can be reverse scaled such that the meter's high calibration value outputs 4 mA and the meter's low calibration outputs 20 mA.

Loop-Powered Relay Alarm Trip for General Purpose & Hazardous Areas

The two solid-state relays can be used as a loop-powered relay alarm trip in both general purpose and hazardous areas. The Loop Leader+ two relays can be programmed for two different kinds of latching operation: Reset via momentary contact closure at any time or reset via momentary contact closure only after the alarm has cleared. And the meter's display can be programmed to turn red and flash a unique custom alarm message for each relay – something not found on most loop-powered alarm trips.

Sampling Relay

A relay set to sample will trigger when the total or grand total value has incremented by a programmed amount. The relay can be programmed to stay on for a specified amount of time. For example: if a relay is set to sample the total with a COUNT of 1,000 and a TIME of 10 seconds, the relay will energize for 10 seconds each time the total increments by 1,000 (e.g. 1000, 2000, 3000).

Resetting the Open Collectors and Relays

The open collectors and relays (alarms) may be programmed to reset in the following ways:

- **Automatic (AUTO):** Alarm will reset automatically once the alarm condition has cleared.
- **Automatic/Manual (AUTOMAN):** Alarm will reset automatically once the alarm condition has cleared but can also be reset using the Enter button (or whichever function key is set to acknowledge) at any time.
- **Latching (LATCH):** Alarm must be reset manually and can be done so at any time. Press the Enter (ACK) button at any time to clear the alarm.
- **Latching with Reset after Cleared (L-CLEAR):** Alarm must be reset manually and can only be done so after the alarm condition has cleared. Press the Enter (ACK) button after the alarm condition has cleared to reset the alarm.

Timer Function

Timers are used in everyday life; one of the most common examples is the microwave oven. Industrial timers are used in process control applications where certain events or actions need to be controlled by time. Examples include automatic batch control applications, where the relay needs to be energized for a specific length of time.

The timer function is available on the open collector and relay outputs; which means that you can have up to four timers per meter. The start and stop actions can be triggered from the setup menu or by the function keys and digital input. The meter can be setup to display the off/on timer count down.

There are two modes of operation:

- **Continuous Timer (Interval)**
At the start of the timer the output is off and turns on after the Off Delay elapses. The output remains on for the duration of the On Time. The cycle repeats until the user stops the timer either from the menu or a function key.
- **One-Shot Timer**
At the start of the timer the output is off and turns on after the Off Delay elapses. The output remains on for the duration of the On Time. The timer stops and the cycle does not repeat.

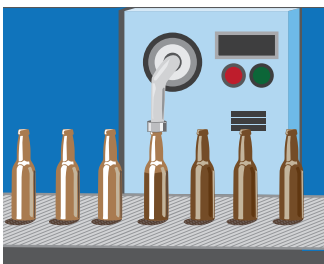

1. A sensor detects the bottle is in place and triggers the digital input to start the timer
2. The timer output controls the filling pump
3. The On Time is set according to the time needed to fill the bottle

BATCH CONTROL

The Loop Leader+, when ordered with the two solid-state relays, can be used as a simple, one or two-stage batch controller. The user enters a preset and preclose value and sets the Loop Leader+ to either count up or count down. The top display will show the total and the bottom display will show the preset batch amount. The function keys are automatically changed so that F1 starts a batch, F2 opens the preset menu to allow the preset value to be changed, and F3 pauses/stops the currently running batch. Batching can be either automatic or manual.

Batch Control Operation Example

The following example shows how two-stage manual batch control functions with a Loop Leader+. This setup will establish a 55-gallon preset for the batch, with a main valve (high flow) that will close at 50 gallons, and a trickle valve (low or restricted flow) that will close at 55 gallons. Because the first batch overruns by 0.10, the batch preset will be changed to 54.90 for the next batch to compensate for overrun.

Two-Stage Manual Batch Control Setup Using Relays 1 and 2

Parameter	Setting	Function
RELAY OUTPUT 1	RLY 1 BATCH	Press Enter to assign relay 1 batch parameters.
BATCH COUNT	UP or DOWN	Setup batch to count up or down.
BATCH MAXIMUM	100.00 GAL	This setting prevents the operator from entering a preset value that exceeds a safety limit for the batch process.
BATCH MODE	MANUAL AUTO	Press Enter to select manual or automatic batch control.
BATCH PRESET	55.00 GAL	Enter the batch size.
BATCH DELAY	ON <input type="checkbox"/> OFF	Enter the On & Off time delays for relay 1, if desired.
RELAY OUTPUT 2	RLY 2 BATCH	Press Enter to assign relay 2 batch parameters.
BATCH PRECLOSE	YES PRECLOSE 5.00	Set the pre-close value to 5 to close the valve being controlled by relay 2 so it closes five gallons before reaching the preset.
BATCH DELAY	ON <input type="checkbox"/> OFF	Enter the On & Off time delays for relay 2, if desired.
RELAY MESSAGE	MSG RELAY 1	Enter a message to be displayed while relay 1 is on, if desired.
	MSG RELAY 2	Enter a message to be displayed while relay 2 is on, if desired.

If only one-stage batch control is desired, do not assign relay 2 to batch. The following pages show illustrations of how the above settings control the batch operation. The display assignment shown is the default.

Manual Batch Control

The manual batch control feature is used for batch processes that the operator wants to start manually. It can also be used where the batch size needs to be manually adjusted for each batch. The batch can be controlled using a [PDA2364-MSBS](#) control station connected to the remote contacts.

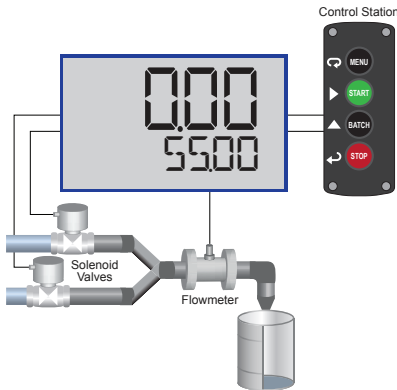

System Setup

Both valves are closed with an empty barrel in place. The batched total is displayed in the upper display, the preset is selected for the lower display.

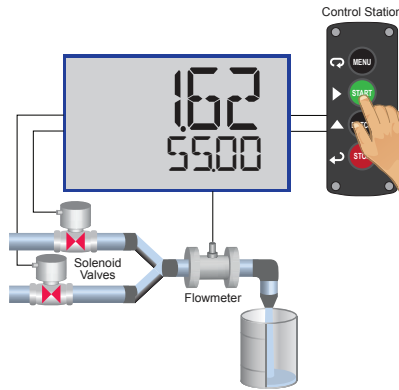

Batch Start

The START button or (F1) is pressed. Both valves open. The barrel begins to fill.

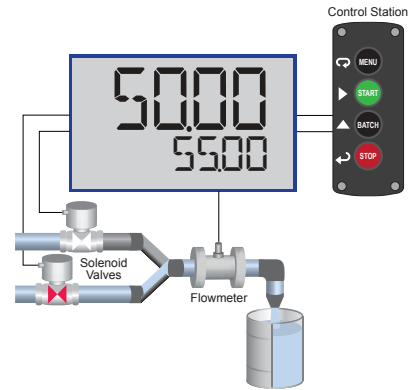

Preclose Valve

When the batch total reaches a value of 50.00 (Preset [55.00] – Pre-close [5.00]) the full-flow valve closes. The fill rate of the tank slows as a result.

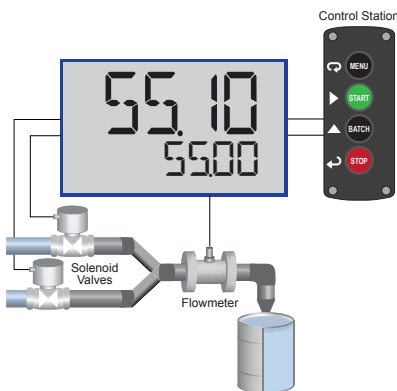

Completed Batch

When the batch is complete, the restricted flow valve closes. If overrun occurs, then the preset must be adjusted to compensate for the overrun amount. The next batch will only start after the START button or (F1) is pressed.

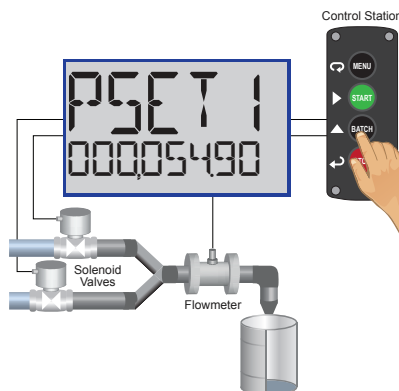

Overrun Correction

To compensate for overrun in the previous batch, adjust the preset to 54.90, so that the next batch is accurate (55.00).

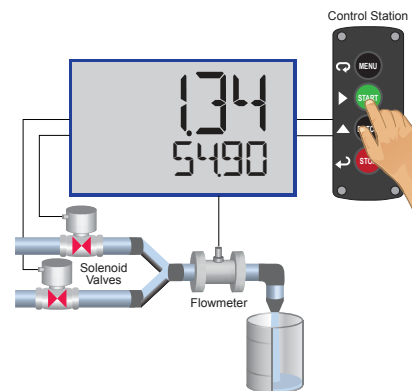

Manual Start of Next Batch

A new, empty, barrel is put in place and the START button or (F1) is pushed to manually start the next batch.

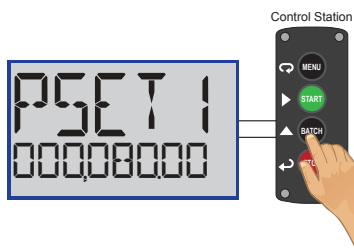

Change Batch Size

While the process is stopped, a new preset fill amount may be selected with the Batch key (F2) for a different size barrel.

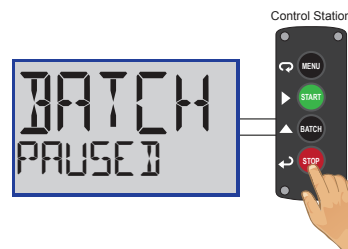

Pause/Stop

At any time, press the STOP button or Stop key (F3) once to pause the process, or twice to cancel the batch, which stops the process.

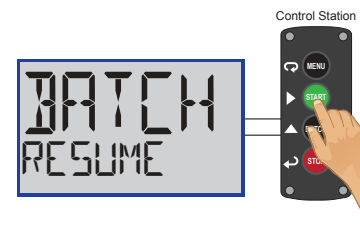

Resume Batch

If the batch has been paused, then press START button or (F1) to resume the batch process.

Automatic Batch Control

The automatic batch control feature is used for batches that start automatically once the previous batch is completed. There is no opportunity for the operator to change the batch size between batches. The batch can be controlled using a [PDA2364-MSBS](#) control station connected to the remote contacts.

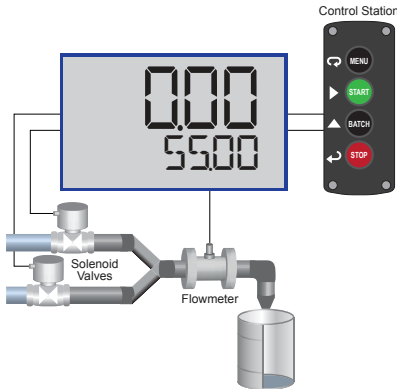

System Setup

Both valves are closed with an empty barrel in place. The batched total is displayed in the upper display, the preset is selected for the lower display.

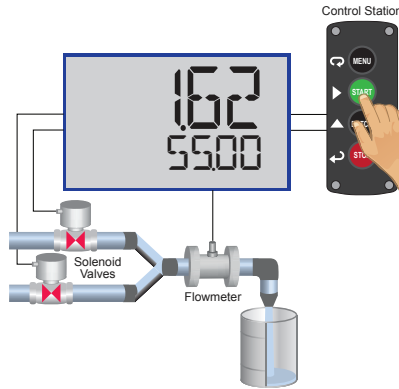

Batch Start

The START button or (F1) is pressed. Both valves open. The barrel begins to fill.

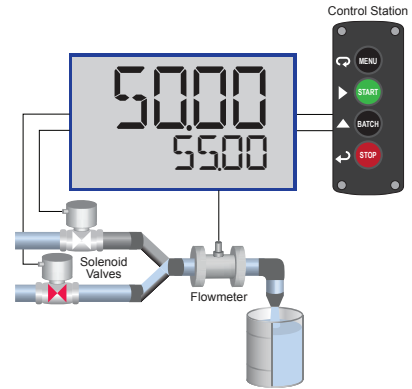

Preclose Valve

When the batch total reaches a value of 50.00 (Preset [55.00] – Pre-close [5.00]) the full-flow valve closes. The fill rate of the tank slows as a result.

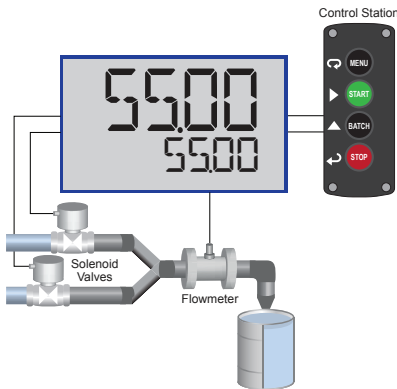

Completed Batch

When the batch is complete, the restricted flow valve closes. If overrun occurs, then the preset must be adjusted to compensate for the overrun amount.

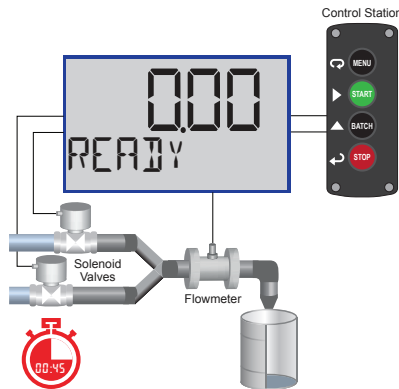

Start Delay

After the batch is completed, the operator removes the full barrel and places an empty barrel; the new batch starts automatically after 60 seconds (Time Delay).

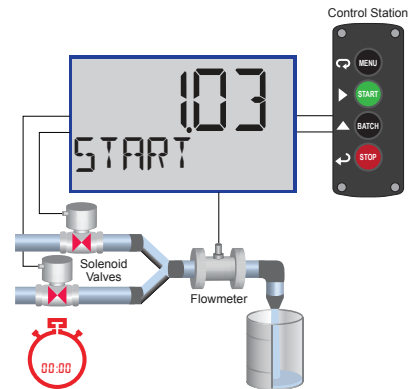

Automatic Start of Next Batch

The next batch begins automatically after 60 seconds, both relays activate and both valves open.

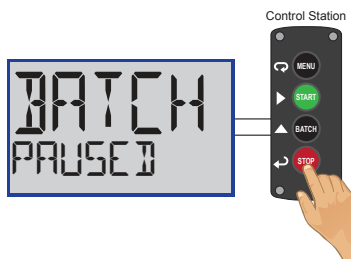

Pause

At any time, press the STOP button or Stop key (F3) once to pause the process.

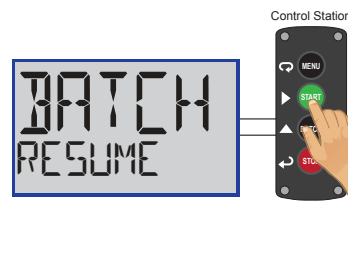

Resume Batch

If the batch has been paused, then press START button or (F1) to resume the batch process.

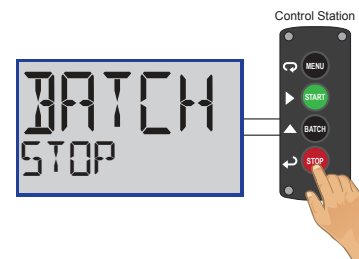

Stop Process

At the end of the shift, press STOP button or Stop key (F3) twice to stop the batch process.

TOTALIZER CAPABILITIES

Loop Leader+ flow rate/totalizers can be programmed for a wide variety of totalizer applications. They can display total, grand total, or non-resettable grand total; the rate can be displayed with a time base of seconds, minutes, hours or days. The user can program a totalizer conversion factor, a non-resettable grand total, password protection, and several total reset methods.

8-Digit Total & Grand Total Display, Up to 13 Digits Using Both Lines

The Loop Leader+ flow rate/totalizer can be programmed to show eight full digits of total on the bottom display or 13 digits of total using both the top and bottom displays. In both cases, the display can be programmed to include commas to make it easier to read the very large numbers; ie 44,987,356.

In 13-digit mode, the bottom line shows the least significant digits and the top line shows the most significant digits. The meter is not capable of displaying commas on the top line, so this number is actually 1,211,230,379. The commas can be removed from bottom if desired. See sample on bottom, right.



8 Digits of Total on Bottom



In 13-Digit Mode

Totalizer Conversion Factor & Multiplier

The user can enter a totalizer conversion factor that allows the meter to display total in different units than the rate. For instance, a customer could measure flow rate in gallons per minute and total in millions of gallons. A multiplier may be selected to automatically display the value in kGAL, MGAL, etc. Use the custom units to display the total in any unit of measure including units in languages other than English.

Totalizer Password Protection

The total and grand total can be password protected so they can be reset only by authorized personnel

Non-Resettable Grand Total

The user can set up the grand total to be non-resettable by selecting YES for PERMLOCK in the *Advanced - Grand Total - Reset* menu. Once this is done, the grand total can never be reset.

Low-Flow Cutoff

The user may program the meter for a low-flow cutoff such that the meter displays zero below this point, regardless of the input value.

Remote Total Reset

The total can be reset via an external contact closure on the digital input.

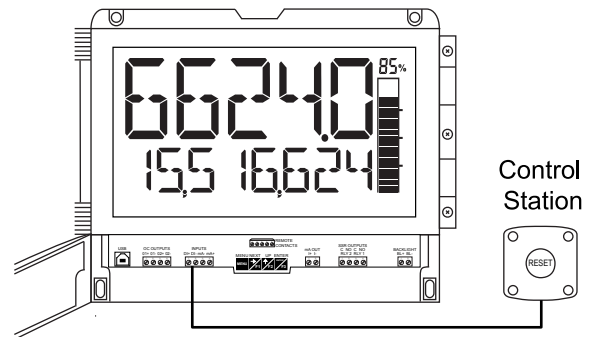

Front Panel Total Reset

The three front panel function keys can be programmed to reset the total and grand total. This makes it possible for the user to reset either the total or the grand total by pressing the appropriate function key. Of course, if the total or grand total is password protected, they will not reset when the function key is pressed unless the password is entered.

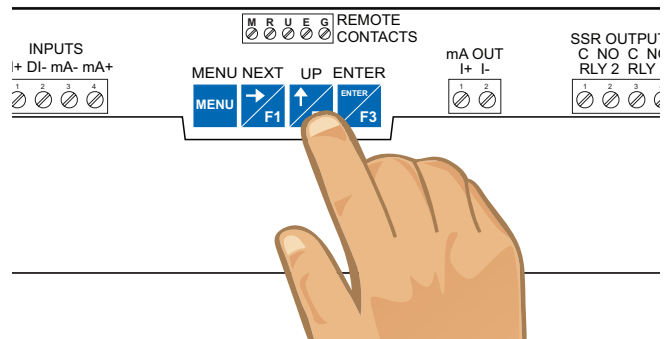

F2 Function Key is Programmed for Reset by Default

Total Alarms

The Loop Leader+ two open collectors and the two relays can be set up to alarm when the total reaches a user-defined set point. A variety of reset modes are available and the user can also program time delays and fail-safe operation.

Total Stored in Non-Volatile Memory

Total and grand total values, and all programmed settings are stored in non-volatile memory for a minimum of ten years if power is lost.

INPUT SIGNAL CONDITIONING

To satisfy applications that require scaling in ways other than the usual 2-point linear method, the Loop Leader+ can also be scaled for square root (differential pressure flow), or programmable exponent (open channel flow).

For existing processes that require these linearization capabilities, one of the great benefits of loop-powered meters is that they get their power directly from the 4-20 mA loop and thus require no additional wiring. All a user has to do is break the existing loop and wire in the meter. For this reason, loop-powered meters are very easy to add to existing applications such differential pressure or open channel flow.

Differential Pressure Flow

The Loop Leader+ can display flow rate and total by extracting the square root from the 4-20 mA signal from a differential pressure transmitter. The user selectable low-flow cutoff feature gives a reading of zero when the flow rate drops below a user selectable value.

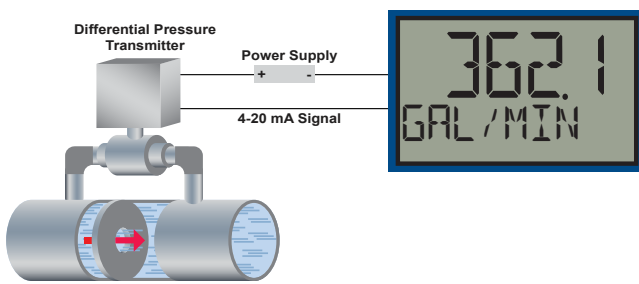

Open Channel Flow

The Loop Leader+, in combination with an ultrasonic level transmitter, makes for an economical way to measure and display open channel flow rate in most weirs and flumes. A guide such as the ISCO Open Channel Flow Measurement Handbook can provide the user with all the information needed: the exponent used in the flow equation for the desired flow units and the flow rate for any given head height. For example, to display the open channel flow rate from a 3" Parshall flume, the ISCO handbook advises the exponent is 1.547 and at the maximum head height of 3.0 feet, the flow rate is 3.508 MGD.

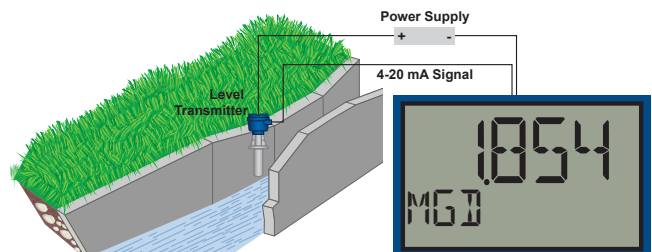

Multi-Point Linearization

Meters are set up at the factory for linear function with 2-point linearization. Up to 32 linearization points can be selected for rate under the linear function. Multi-point linearization can be used to linearize the input for non-linear signals to convert level to flow using weirs and flumes with complex equations.

MeterView XL makes it easy to program up to 32 points.

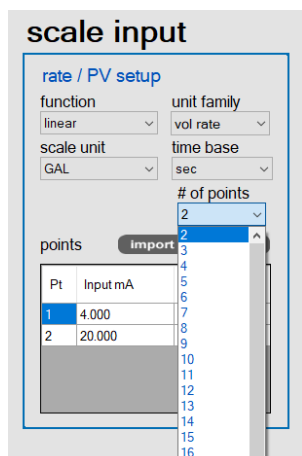

Function	Desire	Programming
Open Channel Flow	3" Parshall flume	Set Programmable Exponent to 1.547
Flow Rate	Millions of Gallons per Day (MGD)	Set 4 mA = 0 & 20 mA = 3.508 Time base = Day
Total	Millions of Gallons	Set Totalizer Conversion Factor = 1 (password protect total reset)
Non-Resettable Grand Total	Program meter so grand total can never be reset	Set non-resettable grand total
Display	Display Flow Rate and Total at the same time	Set upper display for Grand Total and lower display to toggle between rate and total.
Sampling	Take a 1 pint sample every 100,000 gallons	Set up relay for sampling and to trip every 0.1 million gallons. Set up sampling time such that 1 pint is sampled.

PHYSICAL FEATURES

The Loop Leader+ is designed for ease-of-use in industrial applications where it will be exposed to wet, dusty, hot, cold and other adverse conditions. The Loop Leader+ is housed in a rugged NEMA 4X / IP65 enclosure, can operate over a wide temperature range, includes removable screw terminal connectors, and it carries electrical safety approvals. All of these features are backed by a 3-year warranty.

Type 4X / NEMA 4X Front Cover

Not only does the Loop Leader+ Type 4X approval indicate it is waterproof, it also indicates it is rugged. Part of the Type 4X test is to drop a 2 inch, 1 lb, solid stainless steel ball from 4 feet on top of the meter's cover.



Wide Operating Temperature Range

The Loop Leader+ can operate from -40 to 75°C. This means it can be installed in a wide variety of indoor and outdoor industrial applications. And over this range, the Loop Leader+ will drift no more than 0.003% of calibrated span/°C from -40 to 75°C ambient.

Removable Screw Terminal Connectors

Industrial applications require screw terminal connections for easy field wiring and the Loop Leader+ goes one step further in convenience by making them removable also.

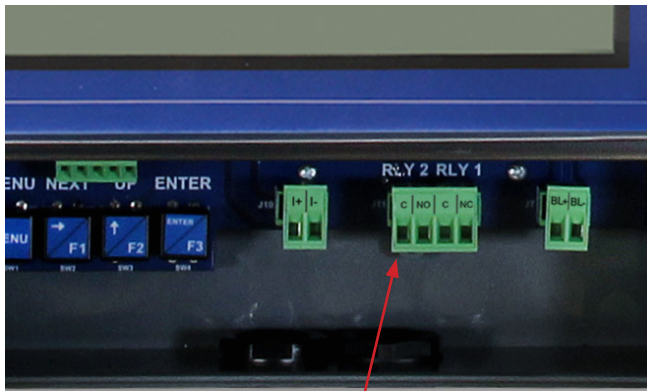

Easy Plug-in Removable Terminal Connectors

USB Port for Easy Connection to Free MeterView XL Software

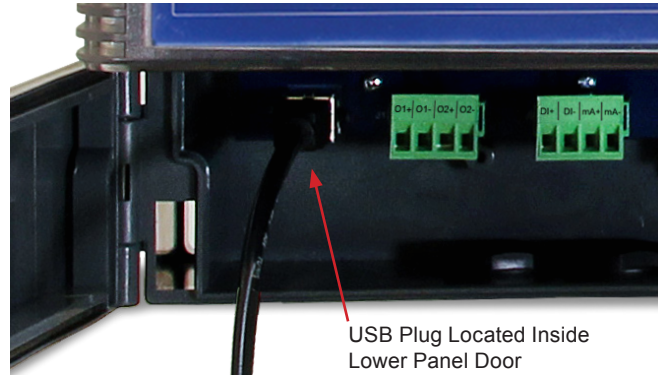

USB Plug Located Inside Lower Panel Door

Integral Holes for Wall Mounting

The Loop Leader+ back panel includes four holes for convenient wall mounting.

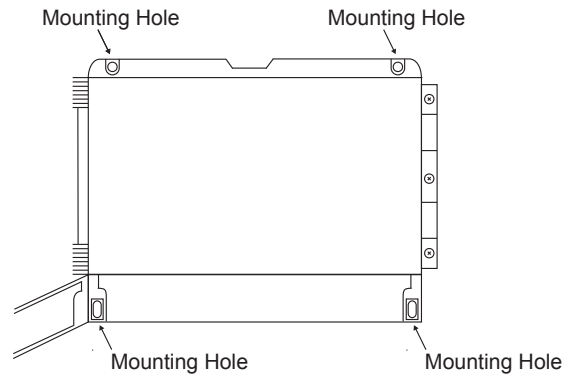

Pipe Mounting Kit

The PD4 can also be mounted to a pipe using the optional pipe mounting kit ([PDA6260](#)). This kit includes two mounting plates, two U-bolts, and the necessary nuts and bolts.

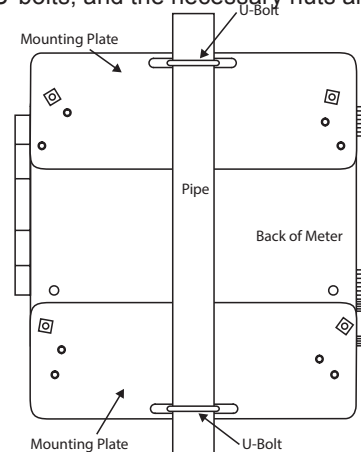



OPERATIONAL FEATURES

Once the meter has been installed and the lower panel door secured, the user can still operate the meter by connecting a control station to the Remote Contacts on the connector board. The user can then operate the four buttons as they are set up by default or change them to provide a variety of different functions by using the programmable function keys.

Programmable Function Keys

Three buttons labeled F1, F2, and F3 located inside the lower panel door can be programmed as function keys to perform a variety of meter functions simply by pressing the button. These include resetting the total, operating the batch control functions, resetting the meter's relays or open collectors, starting and stopping timers, and displaying max/min values. The default settings for the function keys are:

Button	Description (Default Settings)
NEXT 	Press to display grand total. Continue pressing to cycle through max, min, rate, and total displays.
UP 	Press to access the Reset menu. Press F1 to scroll through the options. Press F3 to reset the currently displayed parameter.
ENTER 	Press to acknowledge all manually resettable relays or open collectors. Press to lock/unlock the display value after pressing the F1 key.

For a complete list of Function Keys settings, see *Function Keys & Digital Input Available Settings* on the next page.

On-Board Digital Input

A digital input is standard on the meter. This digital input is programmed identically to the function keys. The input is triggered with a contact closure between DI+ and DI-, or with an active low signal. For a complete list of Digital Input settings, see *Function Keys & Digital Input Available Settings* on the next page.

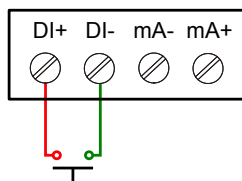

Remote Operation of Meter

The meter can be operated remotely by connecting a [PDA2364-MRUE](#) control station to the Remote Contacts located behind the lower panel door of the meter or use [PDA2364-MSBS](#) control station for batch control operation.

Note: The control station does not carry hazardous area approvals and is not suitable for location in hazardous areas.

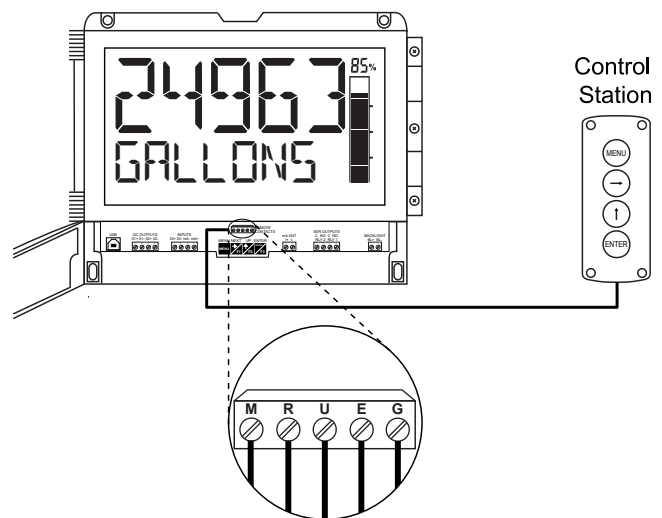

Available Control Stations



Function Keys & Digital Input Available Settings

The following table describes the actions that the Loop Leader+ function keys and digital input can perform.

Display	Description
DISP FN	Set the function key or digital input to display a value
DISPLAY	Cycle max, min, rate, total, and grand total
RATE	Display the rate
TOTAL	Display the Total
DISP GT	Display the Grand Total
PCTRATE	Display the rate's percentage of max (20 mA)
UNITS	Display rate, total, and grand total units
TAG	Display the tags
DISPMIN	Display the minimum rate value
DISPMAX	Display the maximum rate value
MIN MAX	Display the minimum and maximum rate value
mA IN	Display the mA input value
mA OUT	Display the mA output value
MENU FN	Set the function key or digital input to access a menu
RLYINFO	Go to relay information menu (INFO)
MANCTRL	Go to output control menu (CONTROL)
TIMR OC1	Open collector 1 timer
TIMR OC2	Open collector 2 timer
TIMER R1	Relay 1 timer
TIMER R2	Relay 2 timer
TIMERFN	Set the function key or digital input to start or stop a timer
STARTALL	Start all timers
STOPALL	Stop all timers
SSTPALL	Start or stop all timers
OC1	Start/stop open collector 1 timer
OC2	Start/stop open collector 2 timer
RLY1	Start/stop relay 1 timer
RLY2	Start/stop relay 2 timer
START	Start the selected timer output
STOP	Stop the selected timer output
STR--STP	Start or stop the selected timer output

Display	Description
BATCHFN	Set the function key or digital input to batch control
START	Start a batch
STOP	Stop a batch
STR--STP	Start or stop
PRESET	Preset batch amount
ALARMFN	Set the function key or digital input to acknowledge an alarm
ACK	Acknowledge all active alarms
SETPOINT	Set all output set point
SETPTOC1	Set open collector 1 set point
SETPTOC2	Set open collector 2 set point
SETPTR1	Set relay 1 set point
SETPTR2	Set relay 2 set point
SWATCHFN	Set the function key or digital input to activate stopwatch
START	Start the stopwatch
STOP	Pause/Stop the stopwatch
STR--STP	Start or stop the stopwatch
HOLD FN	Set the function key or digital input to hold an output
HOLDOUT	Hold all outputs
HOLDUNHOLD	Hold or un-hold all outputs
OC 1+2	Hold/un-hold open collector outputs
RLY 1+2	Hold/un-hold relay outputs
mAOUT	Hold/un-hold 4-20 mA output
HOLD	Hold selected output
HOLDUNHOLD	Hold or un-hold selected output
DISABLE	Disable the function key or digital input
RST FN	Set the function key or digital input to reset a value
RESET	Reset min, max, or max/min PV value
R MINMAX	Reset max and min PV value

METERVIEW XL PROGRAMMING SOFTWARE

Free, PC-based, MeterView XL software that connects to the meter via a micro USB cable is available for programming and setup of the meters. This software greatly simplifies the programming process and also allows the user to save configuration files for later use. The meter will also be powered by the USB connection so no additional power is needed during programming.

For more information visit
www.predig.com/meterviewxl



WARNING

- The meter should only be connected to a computer while it is located in a safe area.

Main Screen

The main screen displays an image of the connected meter and includes various information about this meter, such as model number, readings, and status.

Input/Scale

The Input/Scale window is used to set the input, scale the input, and enable/disable the dual-scale feature.

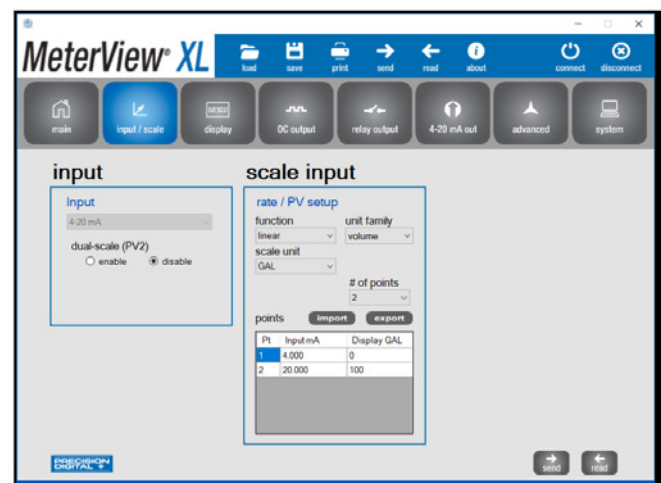

IMPORTANT

- The image in the software shows the panel meter version. The same software is used for the PD4.

Relay Output

The Relay Output window is used to assign a specific task to the 2 relays such as alarm, batch control, sample, timer, stopwatch, or off. A custom message that flashes every 10 seconds can also be added.

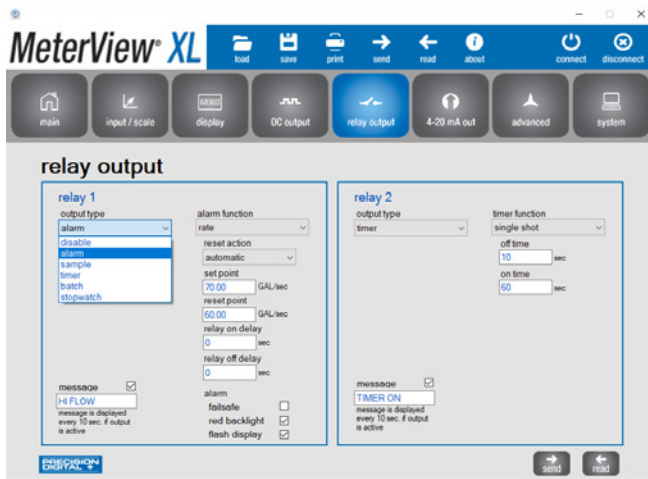

4-20 mA Output

The 4-20 mA Output window is used to program the isolated 4-20 mA output's source, range, and under and over range values.

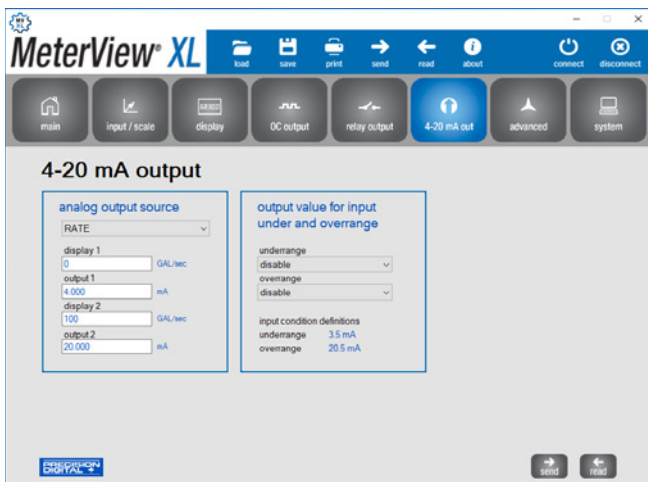

Data Logging

MeterView XL software, when connected to the meter, can generate a log file such as the following example.

Date & Time	rate	units	grand total units
2/22/2021 12:51	4.67	GAL/sec	20 GAL
2/22/2021 12:52	7.32	GAL/sec	119 GAL
2/22/2021 12:52	9.94	GAL/sec	262 GAL
2/22/2021 12:52	12.68	GAL/sec	455 GAL
2/22/2021 12:52	15.34	GAL/sec	687 GAL
2/22/2021 12:53	18.01	GAL/sec	963 GAL
2/22/2021 12:53	20.67	GAL/sec	1283 GAL
2/22/2021 12:53	23.3	GAL/sec	1646 GAL
2/22/2021 12:54	25.95	GAL/sec	2053 GAL
2/22/2021 12:54	28.59	GAL/sec	2504 GAL
2/22/2021 12:54	31.37	GAL/sec	3014 GAL
2/22/2021 12:54	34.04	GAL/sec	3555 GAL
2/22/2021 12:55	36.68	GAL/sec	4139 GAL
2/22/2021 12:55	39.3	GAL/sec	4766 GAL
2/22/2021 12:55	42.05	GAL/sec	5458 GAL
2/22/2021 12:56	44.75	GAL/sec	6175 GAL
2/22/2021 12:56	47.4	GAL/sec	6936 GAL
2/22/2021 12:56	50.06	GAL/sec	7740 GAL
2/22/2021 12:56	52.67	GAL/sec	8588 GAL
2/22/2021 12:57	55.39	GAL/sec	9508 GAL
2/22/2021 12:57	58.08	GAL/sec	10445 GAL
2/22/2021 12:57	60.74	GAL/sec	11425 GAL
2/22/2021 12:57	63.38	GAL/sec	12450 GAL
2/22/2021 12:58	66.11	GAL/sec	13551 GAL
2/22/2021 12:58	68.75	GAL/sec	14664 GAL
2/22/2021 12:58	71.4	GAL/sec	15821 GAL
2/22/2021 12:59	74.08	GAL/sec	17022 GAL

Configuration Files

A configuration file can be generated with or without a meter connected to the PC. This makes it possible to prepare meter configurations prior to having the meter in hand. Meter configurations can be saved and re-loaded into other meters. Meter configurations can also be printed.

ACCESSORIES

Plastic Control Stations

The PDA2360 series of plastic control stations provide a convenient way to remotely control devices. The Loop Leader+ Remote Contacts and/or digital input can be wired to any of the following control stations to perform a variety of tasks.

Model	Description
PDA2360-E	Emergency Button
PDA2361-A	Ack Button
PDA2361-B	Blank Button
PDA2361-R	Reset Button
PDA2361-T	Tare Button
PDA2361-S	Stop Button
PDA2361-Q	Silence Button
PDA2362-AR	Ack and Reset Buttons
PDA2362-BB	Two Blank Buttons
PDA2364-MRUE	Menu, Right, Up, Enter Buttons
PDA2364-MSBS	Menu, Start, Batch, Stop Buttons

Notes:

- Control stations can be connected directly to the meter's Remote Contacts or Digital Input terminals labeled DI+ and DI-.



PDA2364-MRUE



PDA2364-MSBS



PDA2362-AR



PDA2362-BB



PDA2360-E



PDA2361-A



PDA2361-B



PDA2361-R



PDA2361-T



PDA2361-S



PDA2361-Q

Signal Splitter & Conditioner Accessories



The PD659 series includes DIN rail mountable models for signal isolation, splitting and conditioning of 4-20 mA and 0-10 VDC signals.

Model	Description
PD659-1MA-1MA	Signal Isolator with One 4-20 mA Input and One 4-20 mA Output
PD659-1MA-2MA	Signal Splitter with One 4-20 mA Input and Two 4-20 mA Outputs
PD659-1V-1MA	Signal Conditioner with One 0-10 VDC Input and One 4-20 mA Output
PD659-1MA-1V	Signal Conditioner with One 4-20 mA Input and One 0-10 VDC Output

WARNING

- These accessories do not carry hazardous area approvals and are thus not suitable for location in hazardous areas. The use of additional protective devices may allow them to be installed in a safe area and connected to a device in a hazardous area. User should consult a professional engineer to determine suitability of these products for their specific application.

PD9501 Multi-Function Calibrator



This PD9501 Multi-Function Calibrator has a variety of signal measurement and output functions, including voltage, current, thermocouple, and RTD.

Model	Description
PD9501	Multi-Function Calibrator

Pipe Mounting Kit



The meter can be mounted to a pipe using the PDA6260 pipe mounting kit, which includes two mounting plates, two U-bolts, and the necessary nuts and bolts.

Model	Description
PDA6260	2" Pipe Mounting Kit for PD4

PD9502 Low-Cost Signal Generator



The PD9502 is a low-cost, compact, simple to use 4-20 mA or 0-10 VDC signal generator. It can easily be set for 0-20 mA, 4-20 mA, 0-10 V or 2-10 V ranges. Signal adjustment is made with a one-turn knob. A wall plug is provided with the instrument. Optional USB power bank is available.

Model	Description
PD9502	Low-Cost Signal Generator
PDA1001	USB Power Bank

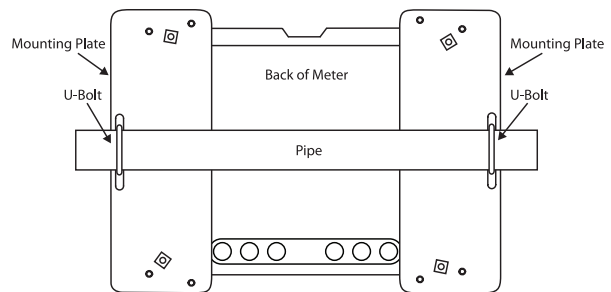
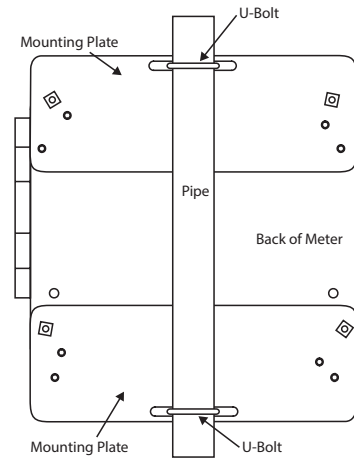

Vertical or Horizontal Pipe Mounting

WARNING

- These accessories do not carry hazardous area approvals and are thus not suitable for location in hazardous areas. The use of additional protective devices may allow them to be installed in a safe area and connected to a device in a hazardous area. User should consult a professional engineer to determine suitability of these products for their specific application.

LIGHT / HORN & BUTTON ACCESSORY

Loop Leader+ Meter with MOD-PD2LH Light / Horn and Button.
 MOD-PD2LH Sold Separately.



An external power supply must be used such as the PDA1024-01 to power up the Light / Horn.



Each Light / Horn accessory comes with 9 labels for the button.

Overview

The Loop Leader+ can be provided with an optional light(s) with built-in 85 dB horn that comes mounted and wired to the instrument by ordering a MOD-PD2LH Light / Horn as a separate item. Light / Horns can also be ordered as separate items to be mounted as the user desires by ordering a PDA-LH Light / Horn. An external 24 VDC power supply is required to power the Light / Horn. The MOD-PD2LH is available in three configurations. The first is a Light / Horn with a single color light (red, green, yellow, blue, or white). The second is a Light / Horn with a user selectable light color by connecting the appropriate wire. The third is a Light / Horn with red, yellow, and green layers users can turn on independently. The light and horn can be controlled independently of each other via separate relays on the meter. The meter's relays can be reset in a variety of ways, allowing several ways the Light / Horn can operate. For instance, the horn can be programmed to silence at any time via the Button or a function key on the front panel, and light to reset automatically when the alarm clears as the following table illustrates:

Relay #	Connected to	Default Reset Mode
1	Flashing Light ⁽¹⁾	Auto reset
2	Horn	Silence with Reset Button at any time

1. Light can be wired to flash or stay steady on.

Dimensions

Units: Inches (mm)

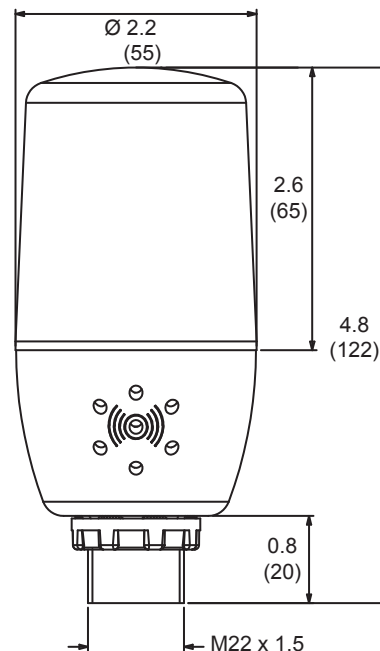

WARNING

- These accessories do not carry hazardous area approvals and are thus not suitable for location in hazardous areas. The use of additional protective devices may allow them to be installed in a safe area and connected to a device in a hazardous area. User should consult a professional engineer to determine suitability of these products for their specific application.

24 VDC Transmitter Power Supply

The [PDA1024-01](#) 24 VDC power supply can be used for a variety of functions like powering 4-20 mA transmitters, the PD4's backlight, and the light/horn accessory. It can be mounted on a [PDA1002](#) DIN rail.



Specifications

Input Voltage	85-264 VAC; 120-370 VDC
Output Voltage	21.6-29 VDC; 1.5 A rated current.
Input Frequency	47-63 Hz
AC Current	115 VAC: 0.88 A; 230 VAC: 0.48 A
Connections	Screw terminals
Overload Protection	105-160% rated output power. Constant current limiting, recovers automatically after fault condition is removed
Operating Temperature	-30 to 60°C (-22 to 140°F)
Vibration	10-500 Hz, 2G 10 min./1 cycle, period for 60 min. each along X, Y, Z axes
Safety Standards	UL 508 Listed and UL Recognized Component
Dimensions	1.40" x 3.50" x 2.10" (35 mm x 90 mm x 54.5 mm) (W x H x D)
Warranty	1 year parts & labor

Wiring Connections for MOD-PD2LH Models

The Light / Horn cannot be powered by the 4-20 mA loop. To use the Light / Horn an external power supply must be used such as the [PDA1024-01](#) as the following diagram illustrates.

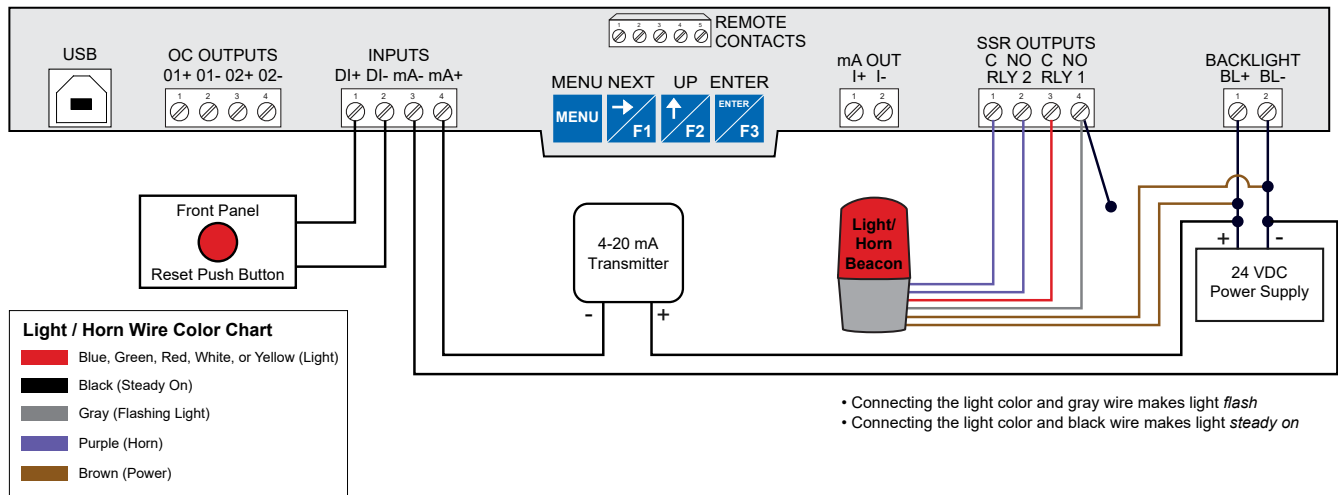

Complete Product Line of Loop-Powered Meters

WITH ALL THE SAME FEATURES & FUNCTIONALITY



2 Open Collector
Outputs



2 Solid-State
Relays



4-20 mA
Output



Two-Color
Backlight

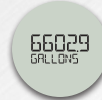

Dual-Line
Displays



Pump
Control



Batch
Control



Ex CE IECEx

LARGE DISPLAY ❖

PD4 Loop Leader+ Series

- NEMA 4X, IP65 Rated Wall-Mount Enclosures
- Large 5-Digit, 2.5" High Top Display
- Safe Area and I.S. Models
- ATEX and IECEx Certified



IECEx



IECEx

VantageView+ CE

EXPLOSION-PROOF ❖

PD6900 ProtEX+ Series

- NEMA 4X, IP68 Rated Aluminum and Stainless Steel Enclosures
- CapTouch Through-Glass Buttons
- Explosion-Proof & I.S.
- CSA, ATEX, and IECEx Certified

1/8 DIN PANEL MOUNT ❖

PD6600 Loop Leader Series

- NEMA 4X, IP65 Rated Front 1/8 DIN Panel Mount Meters
- General Purpose and I.S. and N.I. Models
- UL, C-UL, and CE Approved

FIELD-MOUNT ❖

PD6900 VantageView+ Series

- NEMA 4X, IP66 Rated Plastic Enclosure
- CapTouch Through-Window Buttons
- General Purpose



MeterView XL Software Programs All These Products

Go to PREDIG.COM for details

DIMENSIONS

Front and Side View

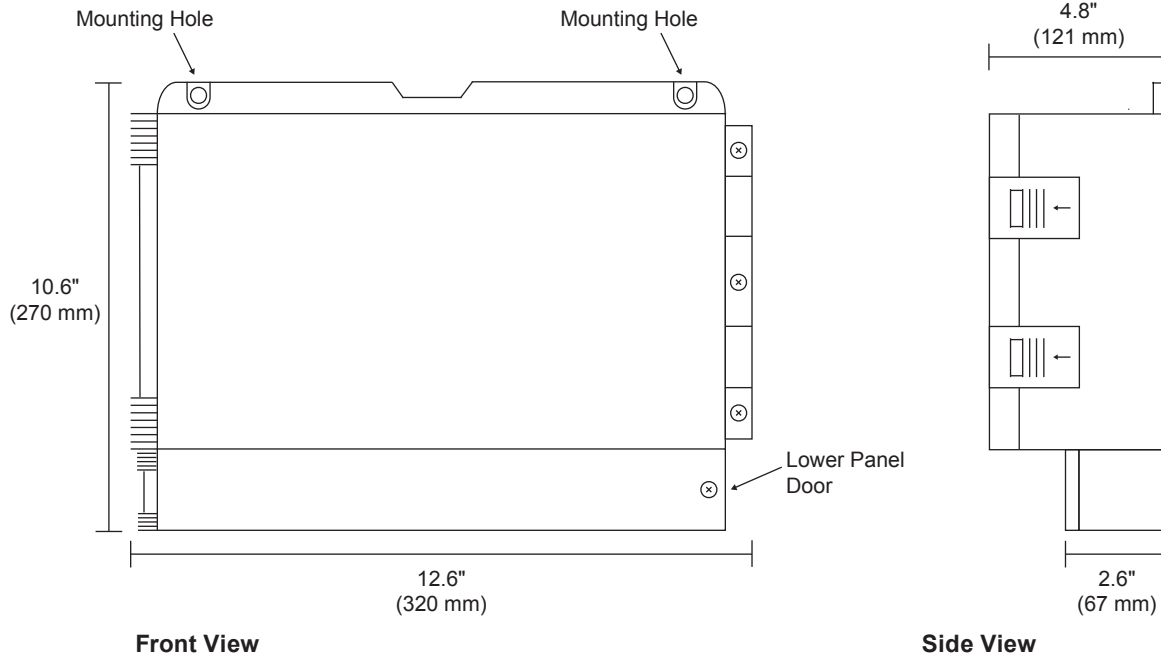

Wall Mounting Holes Location

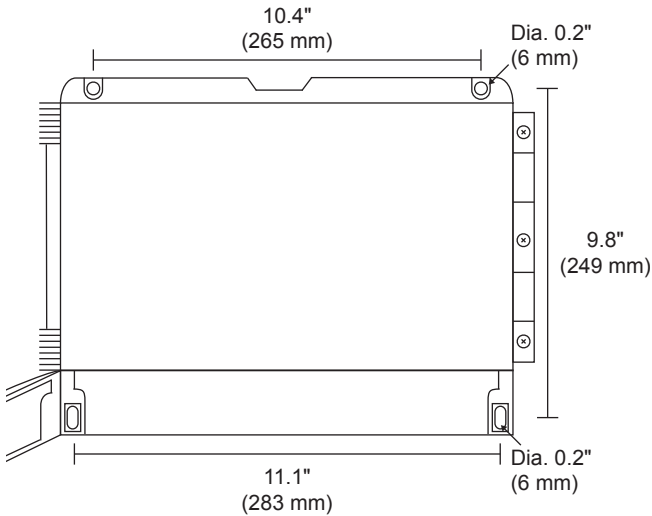

Conduit Holes Location

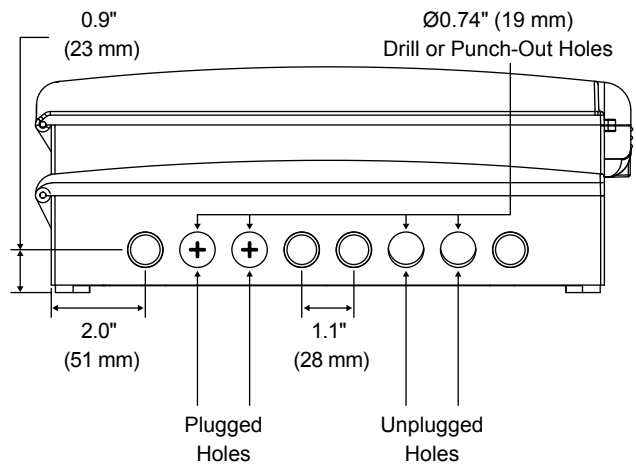

Bottom View



Download free 3-D CAD files of these instruments to simplify your drawings!

predig.com/documentation-cad

CONNECTIONS

Connectors Labeling

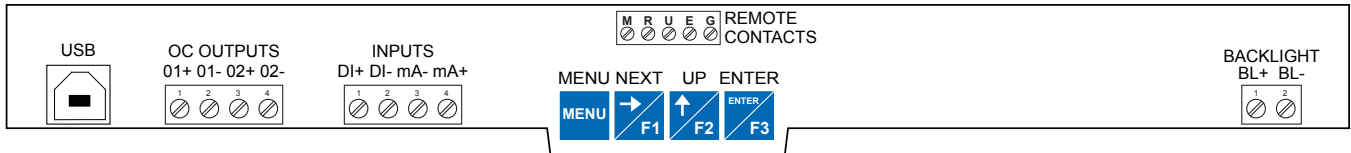

-LNN Base Meter (2 Open Collectors Standard)

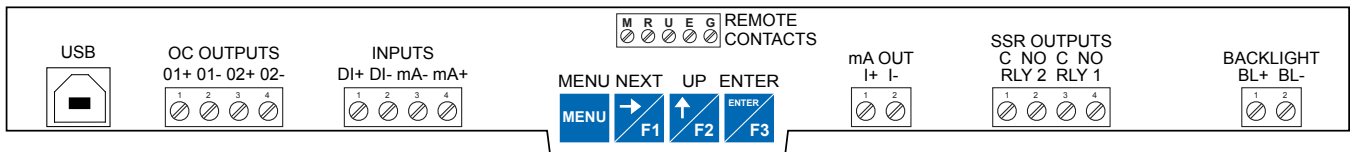

-L5N Option (2 Solid-State Relays and 4-20 mA Output)

USB Connection Location

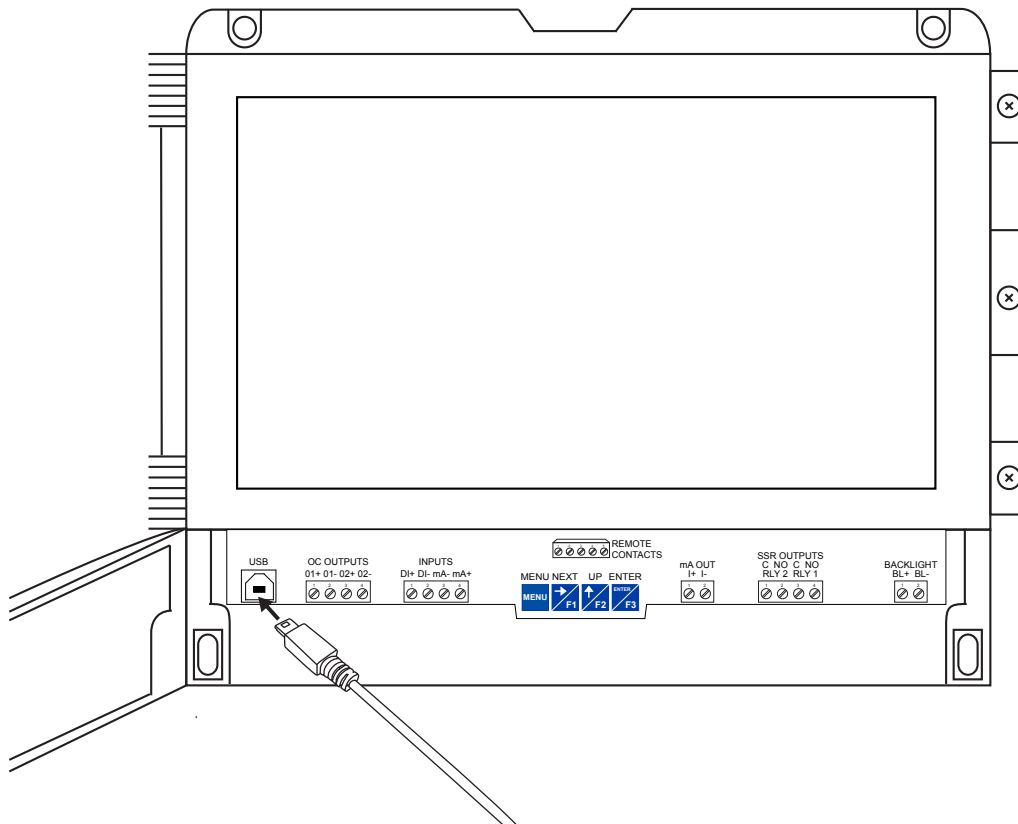

USB cable plug is located inside the lower panel door

WIRING DIAGRAMS

For existing applications, one of the great benefits of loop-powered meters is that they get their power directly from the 4-20 mA loop and thus require no additional wiring. All a user has to do is break the existing loop and wire in the meter.

WARNING

- See Control Drawing [LIM4-6600-2](#) for information on hazardous area wiring.

Safe Area Input Loop (4-20 mA) Connections

The following figures show a 4-20 mA loop connected to the meter. The first figure shows the connection without the backlight and the second shows the connection with the backlight. The meter is powered by the 4-20 mA current loop.

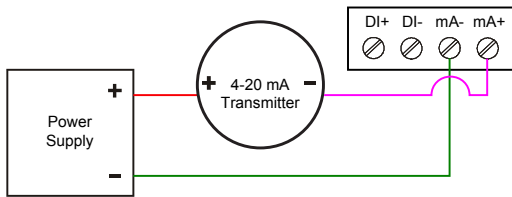

4-20 mA Input Connection without Backlight

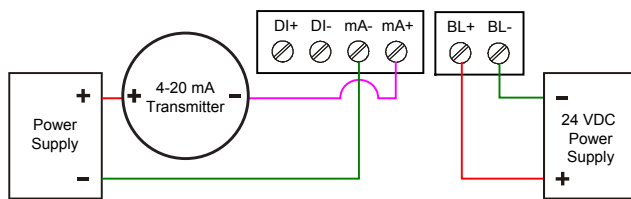

4-20 mA Input Connection with Backlight

Safe Area Digital Input Connections

A digital input is standard on the meter. This digital input is connected with a normally open contact across DI+ and DI-, or with an active low signal applied to DI+ and DI-.

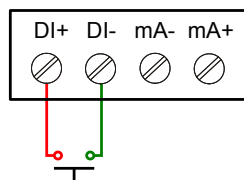

Safe Area 4-20 mA Output Connections

Connections for the 4-20 mA transmitter output are made to the connector terminals labeled mA OUT. The 4-20 mA output must be powered from an external power supply.

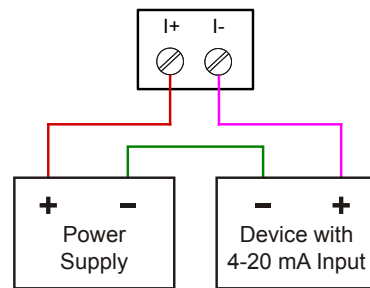

Safe Area Solid-State Relay Connections

Relay connections are made to a four-terminal connector. Each relay's C terminal is common only to the normally open (NO) contact of the corresponding relay.

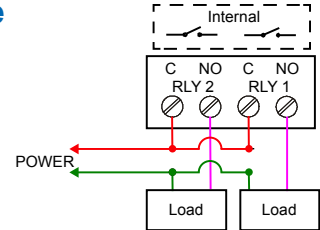

Safe Area Open Collector Outputs

Open collector output 1 and 2 connections are made to terminals labeled O1+ and O1-, and O2+ and O2-. Connect the alarm or pulse input device as shown below.

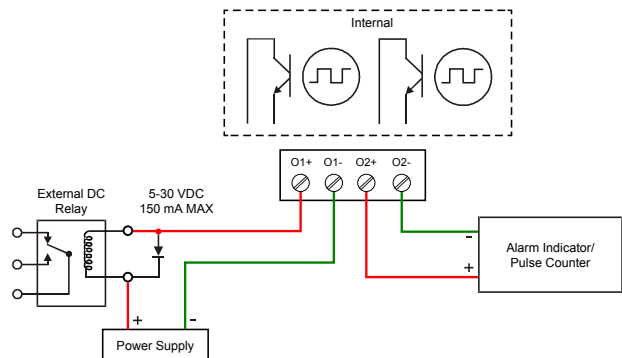

SPECIFICATIONS

Except where noted all specifications apply to operation at +25°C.

Display

Display	Dual-line LCD with backlight. Both lines 14-segment alphanumeric. Top: 2.8" (71 mm) 5 digits Bottom: 1.5" (39 mm) 8 characters Display may be programmed to turn red and flash a user-defined message on alarm condition.
Top Display	5 digits (-9999 to 99999) or 5 characters (all capital & most lower-case letters)
Bottom Display	8 digits (-9,999,999 to 99,999,999; separated by commas) or 8 characters (all capital & most lower-case letters)
Backlight Power Requirement	24 VDC @ 46 mA, typical
Bargraph	20 segments, numeric percent indication at top
Decimal Point	Up to four decimal places on top display and up to seven decimal places on bottom display
Commas	Commas to indicate 1000s (e.g. 88,987,628) on bottom display only
Dual-Scale Feature	The input can be displayed in different scales on the top and bottom displays. For instance, the top display could display the flow in GPM and the bottom display could display that same input in CFM.
Alarm Indication	Programmable: red backlight, flashing display, Bargraph segment flashes on alarm. Backlight requires external 24 VDC.
Custom Alarm Messages	Programmable for each relay/open collector: 8 characters maximum; displayed every 10 sec for 1 sec on bottom display. May be turned off.
Display Update Rate	Ambient > -10°C: 1 Update/Second Ambient = -20°C: 1 Update/2 Seconds From -20°C to -40°C the update rate slows down 1 second for every -2°C (e.g. at -24°C, 1 update/4 seconds).
Overrange	Top: 99999; Bottom: 99,999,999 (flashing)
Underrange	Top: -99999; Bottom: -9,999,999 (flashing)

General

Programming Method	Buttons behind lower panel door & Free PC-based USB programming software
Enclosure & Materials	Material: High impact Polycarbonate with UV stabilizer enclosure, UL 94V-0 Rating: NEMA 4X / IP65 Gasket: Polyurethane Color: gray Includes four PG11 through-hole conduit openings, with two factory installed PG11, IP68, black nylon threaded hole plugs with backing nuts.

Environmental	Operating temperature range: -40 to 75°C (-40 to 167°F) Storage temperature range: -40 to 85°C (-40 to 185°F) Relative humidity: 0 to 90% non-condensing; Printed circuit boards are conformally coated.
Noise Filter	Averages the input signal over a period of time between 1 and 16 seconds to dampen the effects of a noisy signal that causes a jumpy display.
Filter Bypass	0.0 to 99.9% of full scale. Input signal changes greater than bypass value are displayed immediately.
Recalibration	Recalibration is recommended at least every 12 months.
Max/Min Display	Max/min readings reached by the process are stored until reset by the user or until power to the meter is turned off.
Tare	If the totalizer is disabled, the Tare function zeros out the meter to remove the weight of a container. Tare function can be assigned to a function key or the digital input.
Password	There are three separate passwords available that can be set independently of each other: Main, Total, and Grand Total. The Main password prevents access to the meter Programming Mode. Total and Grand Total passwords prevent resetting the total and grand total, respectively.
Non-Volatile Memory	Total and Grand Total values, and all programmed settings are stored in non-volatile memory for a minimum of ten years if power is lost.
Normal Mode Rejection	64 dB at 50/60 Hz
Connections	Removable screw terminals accept 12 to 22 AWG wire. Remote contacts accept 16 to 30 AWG wire.
Tightening Torque	Screw terminal connectors: 4.5 lb-in (0.5 Nm) Mounting screws: 8.0 lb-in max. (0.9 Nm) Remote contacts: 2.5 lb-in (0.28 Nm)
Overall Dimensions	10.6" x 12.6" x 4.8" (270 mm x 320 mm x 121 mm) (H x W x D)
Weight	5.5 lbs (2.5 kg)
Warranty	3 years parts and labor. See Warranty Information and Terms & Conditions on www.predig.com for complete details.

Input

Input	4-20 mA
Accuracy	±0.02% of span ±1 count Square root and programmable exponent: 10-100% FS
Voltage Drop	2.1 V maximum
Equivalent Resistance	105 Ω @ 20 mA
Input Overload	Over current protection to 1 A maximum Over voltage protection to 30 VDC max (between mA+ and mA-/BL-)
Temperature Drift	25 PPM/°C from -40 to 75°C ambient
Function	Linear (2-32 points), square root, or programmable exponent PV2: Linear (2-32 points) or round horizontal tank (If total is disabled and PV2 is enabled)
Low-Flow Cutoff	0.1 to 999,999 or disable. Point below at which the display always shows zero.
HART Transparency	The meter does not interfere with existing HART communications; it displays the 4-20 mA primary variable and it allows the HART communications to pass through without interruption. The meter is not affected if a HART communicator is connected to the loop. The meter does not display secondary HART variables.

Rate/Totalizer

Rate Display	Top display: -9999 to 99999; Bottom display: -9,999,999 to 99,999,999 (with commas)
Total & Grand Total Display	Top display: 0 to 999999; Bottom display: 0 to 99,999,999 (with commas)
13-Digit Total & Grand Total	Up to 9,999,999,999,999 using both lines with 13-digit total feature enabled.
Total Decimal Point	Up to four decimal places on top, up to seven decimal places on bottom. Total decimal point is independent of rate decimal point.
Totalizer	Calculates total based on rate and rate units to display total in engineering units. A custom factor must be programmed if using custom defined units.
Time Base	Seconds, Minutes, Hours, Days
Totalizer Rollover	Totalizer rolls over when display exceeds 99,999,999 (9,999,999,999,999 if 13-digit limit enabled). Relay status reflects display.
Total & Grand Total Reset	Via front panel button, external contact closure on digital input, or MeterView XL.
Total & Grand Total Reset Passwords	Total and grand total passwords may be entered to prevent resetting the total or grand total unless a password is entered.
Non-Resettable Grand Total	Grand total reset may be disabled through the meter interface. Grand total reset may be permanently disabled by selecting YES at the PERMLDCK menu.

CAUTION

- Once the Grand Total has been programmed as “non-resettable” the feature cannot be disabled.

Non-Volatile Memory	Total and Grand Total values are stored in non-volatile memory for a minimum of ten years if power is lost.
----------------------------	---

Batch Control

Methods	Automatic or Manual, count up or count down
Manual Batch Start	Pressing F1 function key starts the batch
Manual Batch Pause/Stop	Pressing F3 once pauses the batch, pressing it twice cancels the batch
Automatic Batching	The Loop Leader+ can be used as an automatic batch controller where batches run continuously without operator input
Batching Relay Operation	Single or dual-relay batching with optional preclose for two-stage operation
Batch Preset	Set via F2 function key anywhere between 0.0001 to 99,999 based on batch total decimal point. If batch total is assigned to bottom, the preset can be up to 8 digits.
Batch Preclose	For two-stage batch application, a preclose value can be set to close the main flow line.
Automatic Batch Restart Delay	1 to 9,999 seconds. The batch will automatically restart after completion of the last batch.

Common Open Collector & Relay Specifications

Number	Two open collectors & two relays
High or Low Alarm	User programmable for high or low alarm
Alarm Deadband	0-100% FS, user programmable
Output Assignment	Alarm, Timer, Stopwatch, or Disable
Alarm Output Source	Assign to rate, total, grand total, or digital input
On & Off Time Delay	0 to 9,999 seconds
Fail-Safe Operation	Independent for each open collector and relay. Fail-safe on, the output is on under normal conditions. Fail-safe off, the output is on under alarm conditions.
Alarm Operation	Automatic, automatic with manual override, latching (manual reset anytime), latching with reset after cleared (manual reset only after alarm has cleared)
Alarm Indication	Programmable: red backlight, flashing display, Bargraph segment flashes on alarm. Backlight requires external 24 VDC.
Custom Alarm Messages	Programmable for each relay/open collector: 8 characters maximum; displayed every 10 sec for 1 sec on bottom display. May be turned off.
Alarm Acknowledge	Front panel ACK button or external digital input resets output and screen indication.
Auto Initialization	When power is applied to the meter, open collectors and relays will reflect the state of the input to the meter.
Timer Output	One-shot or Continuous Off Time Delay: 1 sec to 99:59:59 (hrs:min:sec) On Time: 1 sec to 99:59:59 (hrs:min:sec)
Stopwatch	Output turns on when started and off when stopped.

Open Collector Outputs

Rating	Isolated open collector, sinking NPN 5-30 VDC @ 150 mA maximum
Output Assignment	Pulse, Alarm, Timer, Stopwatch on/off, or Disable
Pulse Output Source	Pulse output based on Rate, Total, Grand Total, or Test Frequency, Alarm, Timer, Total Reset, Stopwatch on/off, or Disable
Pulse Output Factor	0.000001 to 999,999.9
Pulse Width	0.5 ms @ 1 kHz; 500 ms @ 1 Hz; 50% duty cycle
Pulse Output Frequency	1,000 Hz maximum
Quadrature Pulse Output	Available for Output 2 (90° behind Output 1) 500 Hz maximum
Alarm Output Source	Assign to Rate, Total, Grand Total or Digital Input

Solid-State Relays

Rating	250 VAC/VDC @ 1 A resistive 75 VA; 250VAC; 0.6 A pilot duty (inductive) 25 VA; 250VDC; 0.6 A pilot duty (inductive)
Noise Suppression	Metal oxide varistors across outputs
Relay Assignment	Alarm, Sample, Timer, Batch, Stopwatch on/off, or Disable
Alarm Output Source	Assign to Rate, Total, Grand Total, or Digital Input
Relay Runtime	Meter will keep track of how long each relay has operated and display this information.
Relay Cycles	Meter will keep track of how many times the relays have cycled and display this information.

4-20 mA Transmitter Output (Passive)

Accuracy	±0.05% FS ±0.001mA
Output Source	Rate, total, re-transmit; reverse scaling allowed
Scaling Range	1.00 to 23.0 mA
Disable	High impedance state, less than 1 mA
Calibration	Factory calibrated 4.00 to 20.00 mA
Underrange	1.0 mA, 3.5 mA, or 3.8 mA (If input < 3.5 mA); or Off; user selectable
Overrange	20.5 mA, 20.8 mA, or 23.0 mA (If input > 20.5 mA); or Off; user selectable
Isolation	500 V input-to-output
Temperature Drift	0.5 µA/°C max from -40 to 75°C ambient
External Loop Power Supply	7.0 VDC to 30.0 VDC maximum
Output Loop Resistance	10-750 Ω @ 24 VDC; 10-1100 Ω @ 30 VDC

On-Board Digital Input

Function	Remote operation of front-panel buttons, acknowledge/reset relays, reset total, reset max/min values, etc.
Contacts	2.1 VDC on contact. Connect normally open contacts across DI+ and DI-
Logic Levels	Logic High: 2.4 to 30 VDC (max) Logic Low: 0 to 0.9 VDC

Remote Contacts

Function	Terminals provided for remote operation of all four programming / operation buttons (use PDA2364-MRUE control station).
Remote Buttons	Menu, Right, Up, Enter
Remote Function Keys	F1 / Reset* F2 / Max* F3 / Ack* *Defaults

WARNING

- **DO NOT** connect anything else, other than normally open switch contacts, to the Remote Contacts terminals.

MeterView XL

Availability	Free download from www.predig.com
System Requirements	Microsoft® Windows® 7 & 10
Communications	USB 2.0 (Standard USB A to Micro USB B) Cable provided
Configuration	Configure all parameters on the meter. Configure meters one at a time.
Configuration Files	Generate with or without meter connected; Save to file for later use.
USB Power Connection	Meter is powered by USB connection during programming, if 4-20 mA loop is not connected.

WARNING

- The meter should only be connected to a computer while it is located in a safe area.
- Compatibility** Programs created for Loop Leader and Loop Leader+ may be run on either meter. Programs created for VantageView+ and ProtEX+ can be run on either meter. No other program sharing is permissible.

General Compliance Information

Electromagnetic Compatibility

EMC Emissions	<ul style="list-style-type: none"> CFR 47 FCC Part 15 Subpart B Class A emissions requirements (USA) AS/NZS CISPR 11 Class A ISM emissions requirements (Australia) EN 55011 Group 1 Class A ISM emissions requirements (EU) ICES-001 Issue 4 ISM emissions requirements (Canada)
----------------------	---

EMC Emissions and Immunity	EN 61326-1 EMC requirements for Electrical equipment for measurement, control, and laboratory use – industrial use
-----------------------------------	---

Compliance Information (Select Models)

Hazardous Area Approvals

ATEX	Ⓜ II 1 G D Ex ia IIC T4 Ga EX ia IIIC T200°C Da -40°C ≤ Ta ≤ 75°C Certificate number: CML 18ATEX2091X
IECEX	Ex ia IIC T4 Ga EX ia IIIC T200°C Da -40°C ≤ Ta ≤ 75°C Certificate number: IECEX CML 18.0051X

ORDERING INFORMATION

General Purpose Instruments

PD4-6624 Flow Rate/Totalizer with Bargraph Models	
Model	Description
PD4-6624-LNN	Large Display Loop-Powered Rate/Totalizer, General Purpose, No Options
PD4-6624-L5N	Large Display Loop-Powered Rate/Totalizer, General Purpose, Two Solid-State Relays and 4-20 mA Analog Output

Hazardous Area Instruments

PD4-6628 Flow Rate/Totalizer with Bargraph Models	
Model	Description
PD4-6628-LNN	Large Display Loop-Powered Rate/Totalizer, Hazardous Area, No Options
PD4-6628-L5N	Large Display Loop-Powered Rate/Totalizer, Hazardous Area, Two Solid-State Relays and 4-20 mA Analog Output

Notes:

- All models come standard with two open collector outputs and contacts for remote operation.
- Electrical safety and hazardous area approvals for hazardous area instruments only.

Accessories

General Accessories	
Model	Description
PD659-1MA-1MA	Signal Isolator with One 4-20 mA Input and One 4-20 mA Output
PD659-1MA-2MA	Signal Splitter with One 4-20 mA Input and Two 4-20 mA Outputs
PD659-1V-1MA	Signal Conditioner with One 0-10 VDC Input and One 4-20 mA Output
PD659-1MA-1V	Signal Conditioner with One 4-20 mA Input and One 0-10 VDC Output
PD9501	Multi-Function Calibrator
PD9502	Low-Cost Signal Generator
PDA1002	6" DIN Rail Mounting Kit
PDA1024-01	24 VDC Power Supply for DIN Rail
PDA6260	2" Pipe Mounting Kit for PD4

PDA2360 Series Control Stations	
Model	Description
PDA2360-E	Emergency Button
PDA2361-A	Ack Button
PDA2361-B	Blank Button
PDA2361-R	Reset Button
PDA2361-T	Tare Button
PDA2361-S	Stop Button
PDA2361-Q	Silence Button
PDA2362-AR	Ack and Reset Buttons
PDA2362-BB	Two Blank Buttons
PDA2364-MRUE	Menu, Right, Up, Enter Buttons
PDA2364-MSBS	Menu, Start, Batch, Stop Buttons

PDA-LH Light/Horn	
Model	Description
PDA-LHR	Red Light / Horn
PDA-LHG	Green Light / Horn
PDA-LHY	Yellow Light / Horn
PDA-LHB	Blue Light / Horn
PDA-LHW	White Light / Horn
PDA-LH5C	Light / Horn with User Choice of Red, Green, Yellow, Blue or White Light
PDA-LH3LC-RYG	Light / Horn with Red, Yellow, Green Light Layers

PDA-BUTTON Momentary Pushbutton	
Model	Description
PDA-BUTTON1R	NEMA 4X Red Pushbutton
PDA-BUTTON1G	NEMA 4X Green Pushbutton
PDA-BUTTON1B	NEMA 4X Black Pushbutton

MOD-PD2LH Light/Horn & Button	
Model	Description
MOD-PD2LHRB1	Red Light / Horn / 1 Reset Button Mounted and Wired to Loop Leader+
MOD-PD2LHGB1	Green Light / Horn / 1 Reset Button Mounted and Wired to Loop Leader+
MOD-PD2LHYB1	Yellow Light / Horn / 1 Reset Button Mounted and Wired to Loop Leader+
MOD-PD2LHBB1	Blue Light / Horn / 1 Reset Button Mounted and Wired to Loop Leader+
MOD-PD2LHWB1	White Light / Horn / 1 Reset Button Mounted and Wired to Loop Leader+
MOD-PD2LH5CB1	Light / Horn with User Choice of Red, Green, Yellow, Blue or White Light, Reset Button, Mounted and Wired to Loop Leader+
MOD-PD2LH3CB1-RYG	Light / Horn with Red, Yellow, Green Light Layers, Reset Button, Mounted and Wired to Loop Leader+

Notes

- Specify MOD-PD2LH model as a separate item on the order for the Loop Leader+ to order the Light / Horn accessory installed and wired. Meter is sold separately.

Your Local Distributor is:

Disclaimer

The information contained in this document is subject to change without notice. Precision Digital Corporation makes no representations or warranties with respect to the contents hereof, and specifically disclaims any implied warranties of merchantability or fitness for a particular purpose.

©2022 Precision Digital Corporation. All rights reserved.

⚠ WARNING
Cancer and Reproductive Harm - www.P65Warnings.ca.gov

LDS4-6624_A 12/22