

PD6900 ProtEX+ and VantageView+ Loop-Powered Meters

Data Sheet



ProtEX+
Aluminum Enclosure



ProtEX+
Stainless Steel Enclosure



VantageView+
Plastic Enclosure



IECEX C E

VantageView+ C E

- Fully-Approved Explosion-Proof & Intrinsically Safe Loop-Powered Meters (ProtEX+)
- Loop-Powered Field-Mount Meters (VantageView+)
- 4-20 mA Input Displayed with $\pm 0.02\%$ of Full-Scale Accuracy
- 1.5 Volt Drop (4.7 Volt Drop with Backlight)
- 0.7" (17.0 mm) 5 Digits 7-Segment, FT-IN & Fractions Top Display (PD6907)
- 0.7" (17.0 mm) 5 Alphanumeric Characters Top Display (PD6908)
- 0.4" (10.2 mm) 8 Alphanumeric Characters Bottom Display
- Displays Level in Feet & Inches up to 999 Feet, 11 & 15/16 Inches (PD6907)
- 20-Segment Bargraph Standard
- CapTouch Through-Window Button Programming with Normal and Delayed Modes
- Loop-Powered Backlight with Red Backlight for Alarm Conditions
- (2) Open Collector Outputs Standard; Assignable to Pulse, Alarm, Timer, or Stopwatch
- (2) Optional Loop-Powered Solid-State Relays; Assignable to Alarm, Control, Timer, or Stopwatch
- Stopwatch & Timer Functions to Drive Relays & Open Collectors
- Optional Isolated 4-20 mA Analog Output
- Relay Pump Alternation Based on Level and Runtime
- Round Horizontal Tank Function; Just Enter Diameter & Length
- 32-Point Linearization, Square Root Extraction and Programmable Exponent Function
- Free PC-Based MeterView XL USB Programming Software
- Operating Temperature Range: -40 to 75°C (-40 to 167°F)
- Installation Temperature Range: -55 to 75°C (-67 to 167°F) (ProtEX+)
- Conformal Coated PCBs for Dust & Humidity Protection
- CSA Certified for Explosion-Proof / Dust-Ignition Proof / Flame-Proof (ProtEX+)
- ATEX and IECEx Certified as Intrinsically Safe and Explosion-Proof (ProtEX+)
- Explosion-Proof, IP68, NEMA 4X Die-Cast Aluminum & Stainless Steel Enclosures (ProtEX+)
- Plastic NEMA 4X, IP66 Enclosure (VantageView+)
- 3-Year Warranty

Watch the Loop-Powered
Meters Video



Click or scan

VIDEO



The Most Comprehensive Line of Loop-Powered Indicators on the Market

Precision Digital is broadening its line of loop-powered indicators to include three new product lines:

- PD6900 ProtEX+ Explosion-Proof Meters
- PD6900 VantageView+ General Purpose Field-Mount Meters
- PD4 Loop Leader+ Large Display Field-Mount Loop-Powered Meters

Learn all about these new series and see why Precision Digital now has the most complete line of loop-powered meters on the market!



Watch the Loop-Powered Meters Video
Click or scan

TABLE OF CONTENTS

OVERVIEW 3

DISPLAY FEATURES 5

CAPTUCH THROUGH-WINDOW BUTTONS 9

OUTPUTS 10

PUMP CONTROL 11

INPUT SIGNAL CONDITIONING 13

PHYSICAL FEATURES 14

OPERATIONAL FEATURES 17

METERVIEW XL PROGRAMMING SOFTWARE 19

ACCESSORIES 21

DIMENSIONS 25

CONNECTIONS 26

WIRING DIAGRAMS 28

SPECIFICATIONS 30

ORDERING INFORMATION 33

WHY USE LOOP-POWERED METERS?

The most basic decision a user wishing to display a 4-20 mA signal on a digital display has to make is: should the meter be powered by line voltage or should it be powered by the 4-20 mA loop? The meters in this data sheet are powered by the 4-20 mA loop. The three main benefits of this are:

- No additional power required
- Easy wiring
- Additional digital displays can easily be added in the same loop

The diagram on the right illustrates how a loop-powered meter is wired. Notice there are only two connections made to the meter.

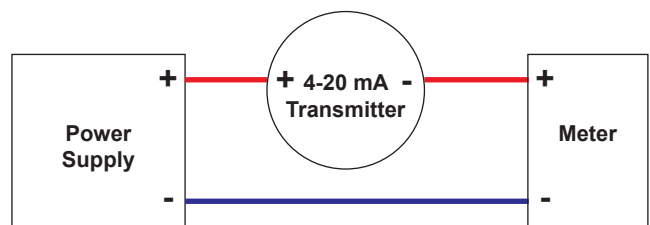

For more information on loop-powered meters, check out these white papers:

[Fundamentals of Loop-Powered Devices](#)

[Loop-Powered vs Line-Powered Meters](#)

OVERVIEW

ProtEX+ Series

Front







PD6907-HA-AL
Feet & Inches Display
Aluminum



PD6908-HA-AL
Decimal Display
Aluminum



PD6907-HA-SS
Feet & Inches Display
Stainless Steel



PD6908-HA-SS
Decimal Display
Stainless Steel

Connections

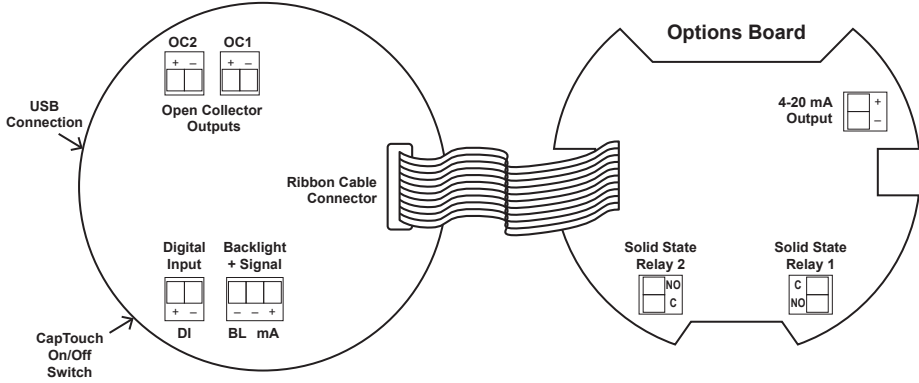

Connections for -L5N Option

Options Board

4-20 mA Output



Solid State Relay 2



Solid State Relay 1



Standard

- (2) Open Collector Outputs Standard (150 mA max); Assignable to Pulse, Alarm, Timer, or Stopwatch
- Digital Input for Remote Operation of a Single Task

Options

- (2) Loop-Powered Solid-State Relays; Assignable to Alarm, Control, Timer, or Stopwatch
- Isolated 4-20 mA Analog Output

Hazardous Area Loop-Powered Indicators with Advanced Display and Control Features

The ProtEX+ loop-powered explosion-proof & intrinsically safe meters can be installed virtually anywhere to provide convenient and informative display of any 4-20 mA signal. They can operate down to -40°C and be installed in areas that get as cold as -55°C, however the display will cease functioning. One of the most convenient features is the dual-line display, typically used to display the process variable on the 5-character alphanumeric top display and the units of measure or tag on the 8-character alphanumeric bottom display. Feet and inches models display level in feet and inches on the top display while the 8-digit alphanumeric bottom line may be used to display a tag or custom message. Further enhancing the display on these instruments is a 20-segment bargraph.

The ProtEX+ Series is CSA Certified for Explosion-Proof / Dust-Ignition Proof / Flame-Proof and ATEX and IECEx Certified as Intrinsically Safe and Explosion-Proof.

Four CapTouch through-glass buttons are available to operate the instrument without removing the cover. Free, PC-based, MeterView XL software that connects to the meter via a micro USB cable is available for programming and setup of the meters.

All models come equipped with two open collector outputs and a digital input. There are also models available with two solid-state relays and isolated 4-20 mA analog output options.

VantageView+ Series

Front





PD6907-GP-PL
Feet & Inches Display
Plastic



PD6908-GP-PL
Decimal Display
Plastic

Connections

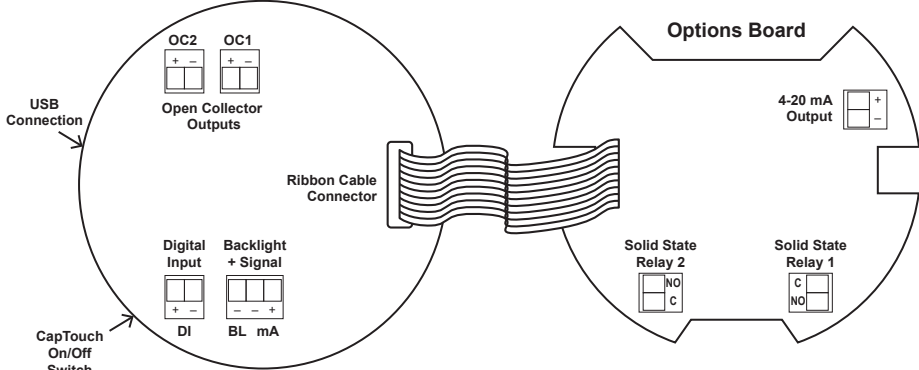

Connections for -L5N Option

Options Board

- 4-20 mA Output
- Solid State Relay 2
- Solid State Relay 1

Standard

- (2) Open Collector Outputs Standard; Assignable to Pulse, Alarm, Timer, or Stopwatch
- Digital Input for Remote Operation of a Single Task

Options

- (2) Loop-Powered Solid-State Relays; Assignable to Alarm, Control, Timer, or Stopwatch
- Isolated 4-20 mA Analog Output

General Purpose Loop-Powered Indicators with Advanced Display and Control Features

The VantageView+ loop-powered meters can be installed in a variety of harsh operating environments to provide convenient and informative display of any 4-20 mA signal. One of the most convenient features is the dual-line display, typically used to display the process variable on the 5-character alphanumeric top display and the units of measure or tag on the 8-character alphanumeric bottom display. Feet and inches models display level in feet and inches on the top display while the 8-digit alphanumeric bottom line may be used to display a tag or custom message.

Further enhancing the display on these instruments is a 20-segment bargraph.

Four CapTouch through-window buttons are available to operate the instrument without removing the cover. Free, PC-based, MeterView XL software that connects to the meter via a micro USB cable is available for programming and setup of the meters.

All models come equipped with two open collector outputs and a digital input. There are also models available with two solid-state relays and isolated 4-20 mA analog output options. The open collector outputs are useful for alarm indication. The digital input can be used to acknowledge the relays, to start/stop a timer/stopwatch, and more. The relays can be programmed for alarm indication, on/off control, or pump alternation.

DISPLAY FEATURES

PD6908 Process Meter with Decimal Display

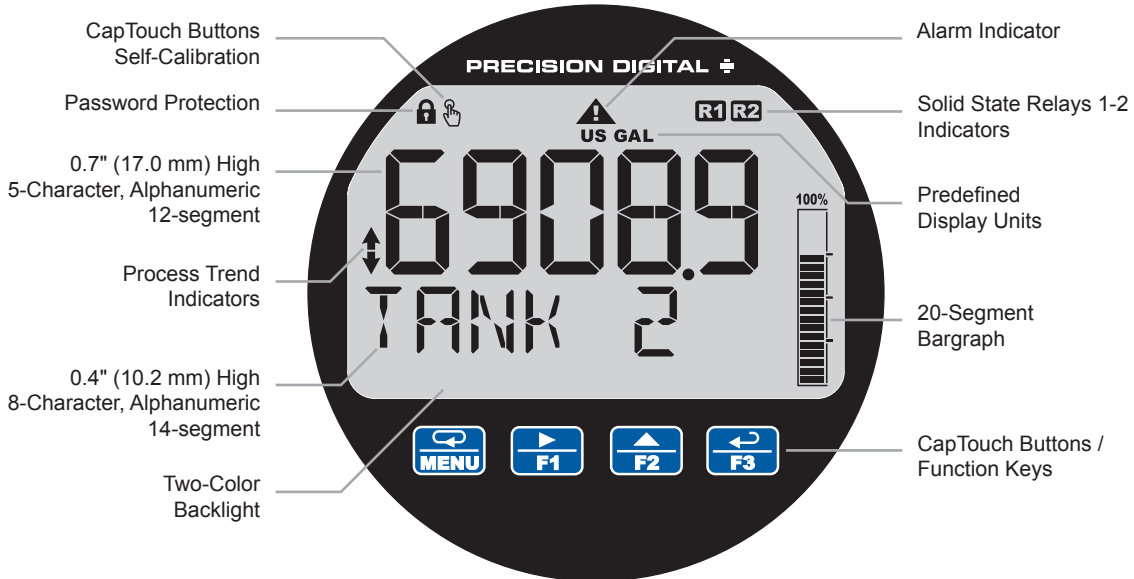

14-Segment Characters on Bottom Display Provide Clearer Readings of Units or Tags

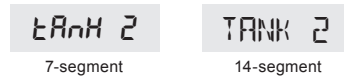

PD6907 Feet & Inches Meter with Bargraph

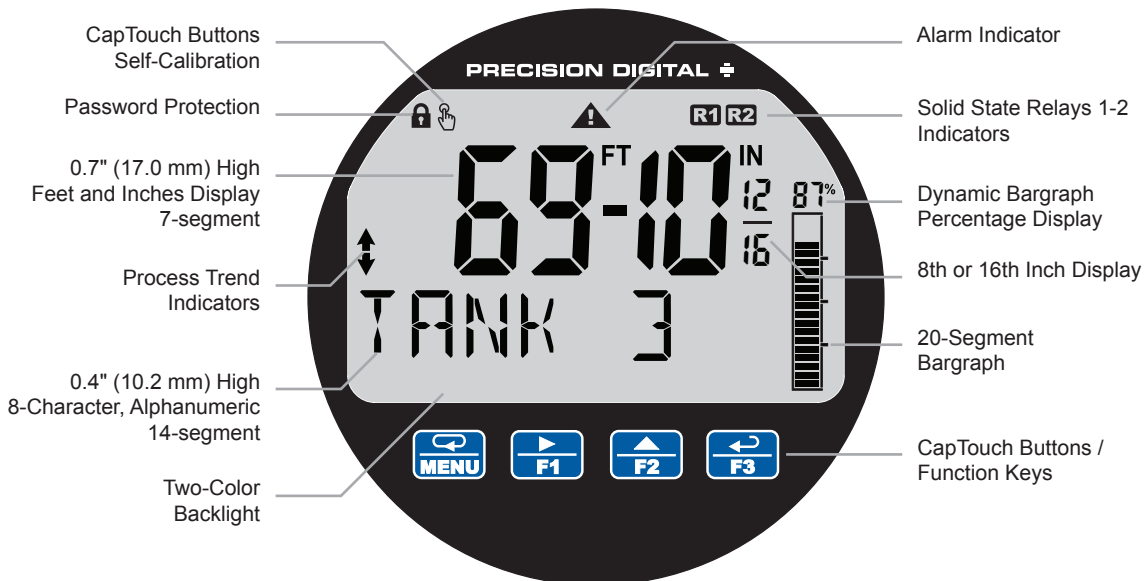

14-Segment Characters on Bottom Display Provide Clearer Readings of Units or Tags



Dual-Line Display with PV/Units/Tag/ Bargraph

One of the most common configurations of these instruments is displaying the process variable on the top line and units and a tag toggling on the bottom line with a bargraph for additional clarity.

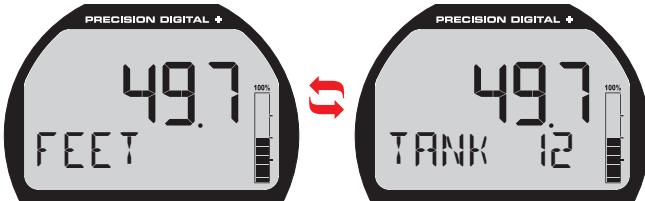

PV on the top line, units and tag toggling on the bottom line

The 20-segment bargraph helps users get a quick understanding of where their process is at. On PD6907 models the bargraph also includes a numeric value of the percentage the bargraph represents.

14-Segment Characters

Notice how much better letters like “T”, “N” and “K” appear as 14-segment characters on the bottom display vs. 7-segment characters found on other meters.



7-Segment



14-Segment

Dual-Scale Display Feature

Users can use the meter’s dual-scale feature when they want to show the same input in two different scales. For instance, the following example shows an application where the meter displays the input in feet and gallons.

Display Feet & Gallons and Toggle Between Units

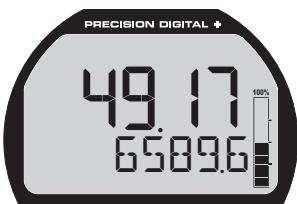

Feet Value on Top
Gallons Value on Bottom

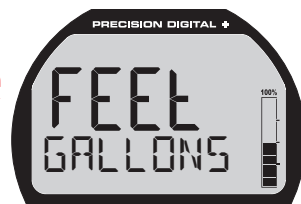

Height Units on Top
Volume Units on Bottom

Backlight Turns Red on Alarm

The loop-powered backlight is standard on all ProtEX+ and VantageView+ meters. It provides optimum visibility in any lighting condition and it can be programmed to turn red for alarm conditions. The backlight may be enabled or disabled using the *Backlight* menu. The backlight is enabled by default (input must be wired appropriately for the loop-powered backlight to function).

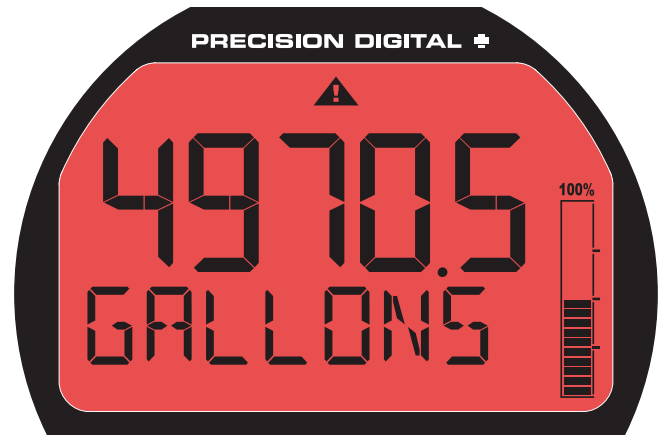

Backlight for Visibility in Any Lighting Condition and Red Backlight for Alarm Indications

Feet & Inches Display with Bargraph

There are models available for users that prefer to see their level displayed in feet & inches instead of decimal format. These versions can display level to 999FT 11IN & 15/16 on the top line. The bottom line can toggle between a tag and units or if dual scale mode is used, can display the input in a different scale such as volume.

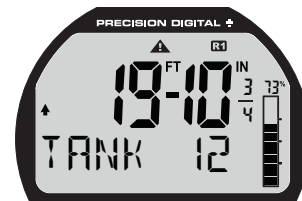

Level in Feet & Inches with Tag and Bargraph

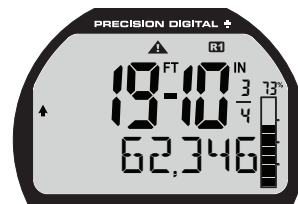

Same Meter with Bottom Line Toggling Between Tag, Volume (62,346), and Units (Gallons)

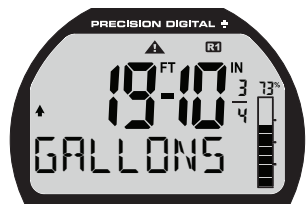

Max/Min Display

The max & min readings (peak & valley) reached by the process can be displayed either continuously or momentarily.

- Display momentarily by pressing the F1 function key (default) or assigning to any of the other function keys or to the digital input in the User menu. Press Enter to lock/unlock max/min display.
- Display continuously by assigning either display line to max/min through the Display menu.

Any of the F1-F3 function keys (buttons) and the digital input can be programmed to reset the max & min readings.

Top Display: Process Value
Bottom Display: Max & Min

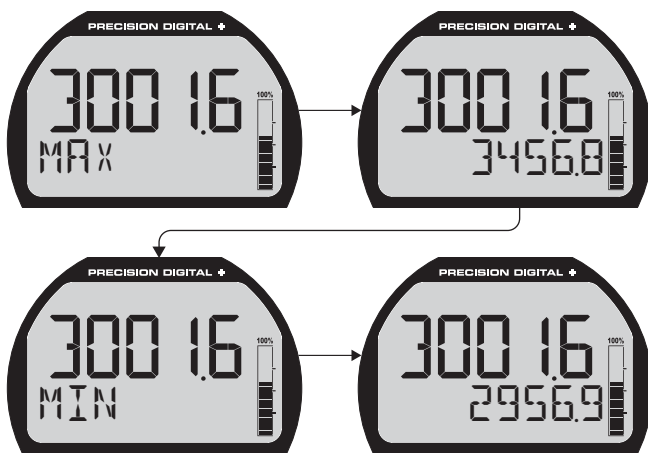

Change Between Units without Needing to Re-Scale the Meter

It is possible to change the display units within the selected unit class without the need to re-scale the meter. When selecting a new unit from within the DISPLAY menu (e.g. changing from gallons (GAL) to liters (L)), the meter will automatically convert the display values to display the new unit. If entering a custom unit (CUSTOM), a custom conversion factor will need to be entered.

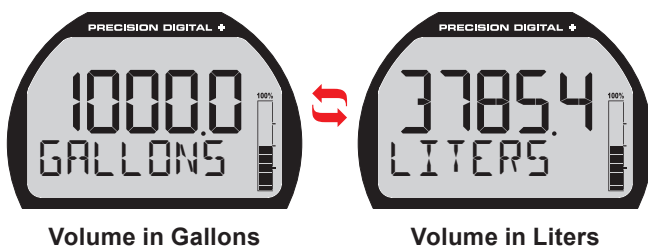

Bargraph Provides Quick Understanding

The 20-segment bargraph helps users get a quick understanding of where their process is at. The bargraph can be programmed to represent the percent of PV1 or PV2 or it can be scaled to any range within the scale.

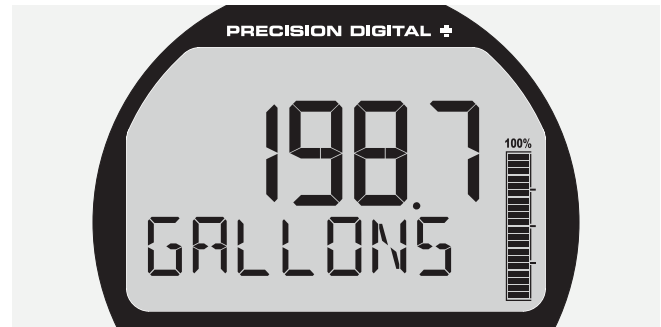

Bargraph indicating a 200 gallon tank is just about full

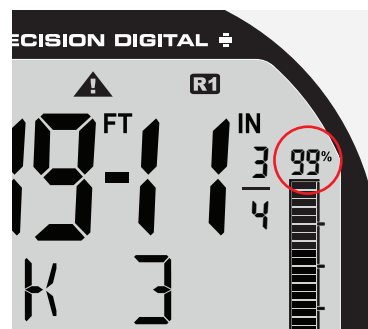

On PD6907 models, the bargraph also includes a dynamic numeric value of the percentage the bargraph represents.

Predefined and Custom Units

The meter has six available preprogrammed unit classes, volume, height, temperature, pressure, weight, and rate. When the desired unit class or unit of measure within a class is not available, a custom unit may be programmed by using the (CUSTOM) menu.

Tare

The tare function zeroes out the display. In the case of scale weight, tare is used to eliminate container weight and provide net weight readings. The captured tare may be reset manually with any function key or digital input.

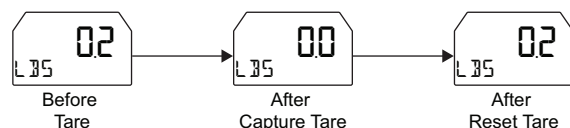

CAPTOUCH THROUGH-WINDOW BUTTONS

All PD6900 meters are equipped with four capacitive sensors that operate as through-window buttons so that they can be operated without removing the cover (and exposing the electronics) in a hazardous area. CapTouch buttons are designed to work under any lighting condition and to protect against false triggering. They can be turned off for security via a switch on the display module.

To actuate a button, press one finger to the window directly over the marked button area. When the cover is removed, the CapTouch buttons can be used after the meter completes a self-calibrating routine (⚡ flashes). The sensors are disabled when more than one button is pressed, and they will automatically re-enable after a few seconds (⚡ off).



CapTouch Buttons Operation Modes

The CapTouch buttons have two modes of operation: *Normal* and *Delayed*.

Normal

Normal is the factory default setting. This mode is recommended for programming the meter or when immediate operation of the buttons is needed.

Delayed

Use the Delayed mode to prevent accidental trigger of the buttons. In the Delayed mode, the buttons enter into a low sensitivity state (sleep) and they ignore quick button presses after 20 seconds of inactivity. To wake up the buttons, press and hold any button for more than 2 seconds, the buttons respond normally.

Turning Off CapTouch Buttons

The CapTouch buttons can be turned off for security by moving the slide switch located on the display module to the Off position.



OUTPUTS

PD6900 meters come with two open collector outputs as standard and two solid-state relays and 4-20 mA output as options. The open collector outputs and relays generally operate in the same manner, with the major exception being the open collectors are not available for pump alternation and the relays are not available with pulse features. The open collectors and relays can be controlled either automatically or manually. The alarm status (with a unique flashing red message for each of the two relays and open collectors) will show on the display even with no output wired.

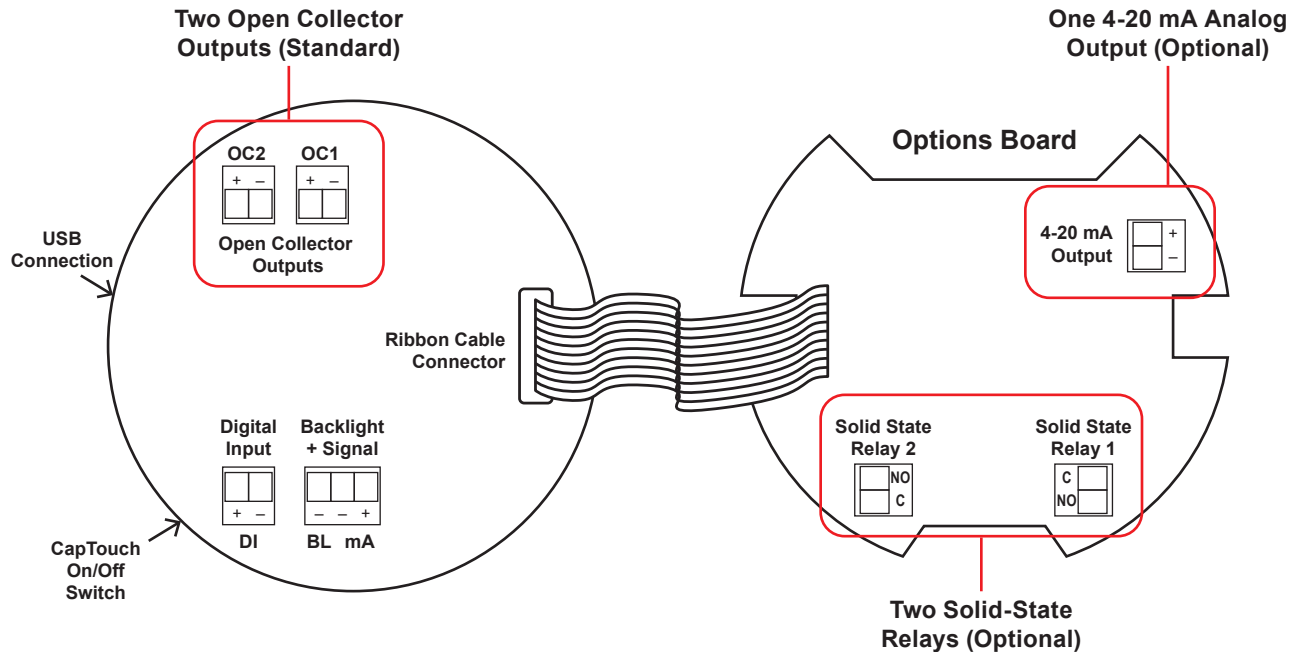

Two Open Collector Outputs

The meter is equipped with two NPN open collector outputs that may be set up for pulse outputs, alarms, timed pulses, stopwatch on/off, or disabled. Pulse outputs can be set to transmit the PV value (PV1 or PV2 if meter is in dual-scale mode). Output 2 may be used to generate a quadrature output based on the other open collector output. An output test mode is also selectable to generate pulses at a constant programmable frequency.

Two Optional Solid-State Relays

The meter is optionally equipped with two solid-state relays that may be set up for alarms, timer, stopwatch on/off, or pump alternation. The relays are rated at 250 VAC/DC @ 0.5 A for resistive loads and 38 VA @ 0.3 A, 250 VAC/DC max (Safe Area only) for inductive loads. Alarms are available based on the PV value or the digital input.

Optional Isolated 4-20 mA Output

The isolated analog output signal can be configured to represent the process variable (PV1, PV2, or retransmit). While the output is nominally 4-20 mA, the signal will accurately accommodate under- and over-ranges from 1 to 23 mA. The output can be reverse scaled such that the meter's high calibration value outputs 4 mA and the meter's low calibration outputs 20 mA.

Loop-Powered Relay Alarm Trip for General Purpose & Hazardous Areas

The two solid-state relays can be used as a loop-powered relay alarm trip in both general purpose and hazardous areas. The meter's two relays can be programmed for two different kinds of latching operation: Reset via momentary contact closure at any time or reset via momentary contact closure only after the alarm has cleared. And the meter's display can be programmed to turn red and flash a unique custom alarm message for each relay – something not found on most loop-powered alarm trips.

Resetting the Open Collectors and Relays

The open collectors and relays (alarms) may be programmed to reset in the following ways:

- **Automatic (RST):** Alarm will reset automatically once the alarm condition has cleared.
- **Automatic/Manual (RST/MAN):** Alarm will reset automatically once the alarm condition has cleared but can also be reset using the Enter button (or whichever function key is set to acknowledge) at any time.
- **Latching (LATCH):** Alarm must be reset manually and can be done so at any time. Press the Enter (ACK) button at any time to clear the alarm.
- **Latching with Reset after Cleared (L-CLEAR):** Alarm must be reset manually and can only be done so after the alarm condition has cleared. Press the Enter (ACK) button after the alarm condition has cleared to reset the alarm.

Timer Function

Timers are used in everyday life; one of the most common examples is the microwave oven. Industrial timers are used in process control applications where certain events or actions need to be controlled by time. Examples include automatic batch control applications, where the relay needs to be energized for a specific length of time.

The timer function is available on the open collector and relay outputs; which means that you can have up to four timers per meter. The start and stop actions can be triggered from the setup menu or by the function keys and digital input. The meter can be setup to display the off/on timer count down.

There are two modes of operation:

- **Continuous Timer (Interval)**
At the start of the timer the output is off and turns on after the Off Delay elapses. The output remains on for the duration of the On Time. The cycle repeats until the user stops the timer either from the menu or a function key.
- **One-Shot Timer**
At the start of the timer the output is off and turns on after the Off Delay elapses. The output remains on for the duration of the On Time. The timer stops and the cycle does not repeat.

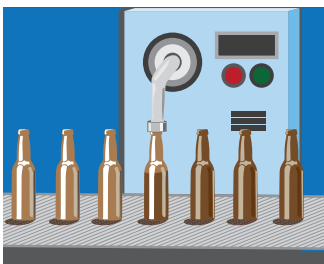

1. A sensor detects the bottle is in place and triggers the digital input to start the timer
2. The timer output controls the filling pump
3. The On Time is set according to the time needed to fill the bottle

Loop-Powered Isolator for General Purpose & Hazardous Areas

The ProtEX+ can be used as a loop-powered isolator for the 4-20 mA signal in both general purpose and hazardous areas with the added benefit of a digital readout to display the process variable.

PUMP CONTROL

PD6900 meters, when ordered with the two solid-state relays, have several features that make them ideal for simple duplex pump control. The relays can be programmed to alternate the pumps based on level and runtime thus ensuring even wear on both pumps. If the level remains constant (within on/off points), alternation is based on runtime. If the level cycles the on/off points, alternation is based on level and runtime. If the runtime is set to 0, alternation is based on level. The meter also keeps track of runtime for both pumps and the number of times they have cycled.

Display Pump Runtime & Cycle Count

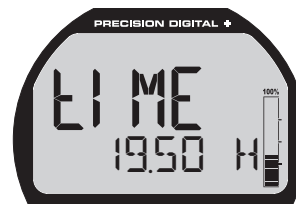

The meter can display pump runtime for both pumps

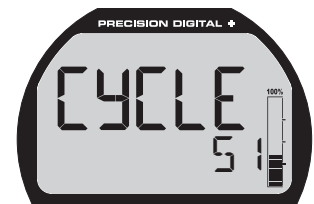

The meter can display the number of times the relays have cycled

In addition to the two solid-state relays for controlling pumps, the meter's two open collectors could be used to indicate high or low level alarm conditions.

Pump Alternation Application

The PD6900 can be used as a pump controller to alternate two pumps and provide high and low level alarm indication. The pumps can be programmed to alternate on level and runtime and the meter can display the pump runtimes and the number of times they have cycled. A ProtEX+ with the -L2N option can be used as an intrinsically safe pump controller.

Pump Control with Alternation & Alarm Example

The following is a typical application where the relays and open collectors are used for pump alternation and high/low level alarm.

Relay	On Point	Off Point	Function
1	7000	2000	Controls backup pump
2	6000	2000	Controls main pump

OC	On Point	Off Point	Function
1	7000	6500	Trips high alarm
2	1000	1500	Trips low alarm

1

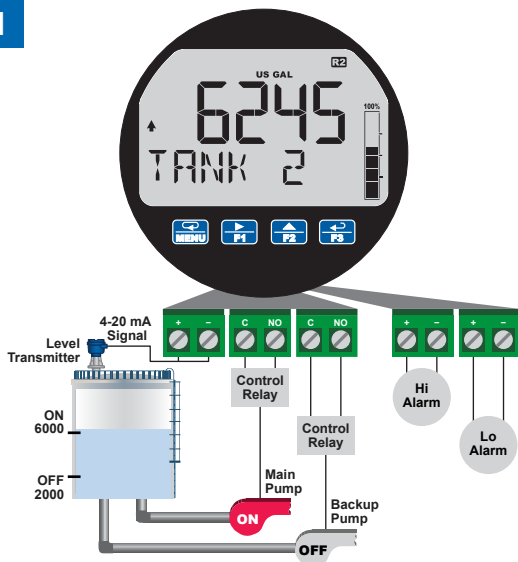

2

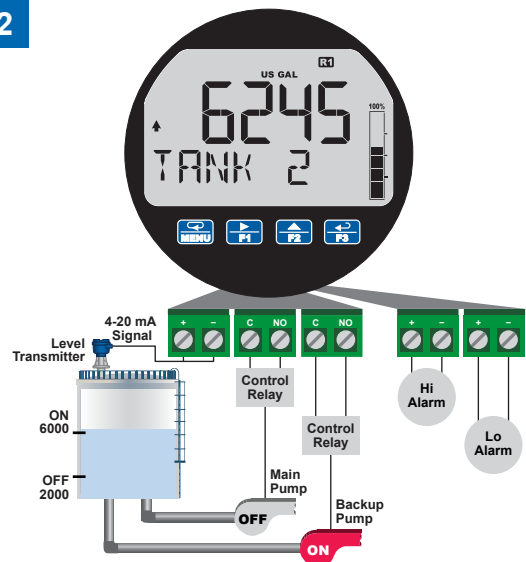

Relay #2 turns the main pump on at 6000 gallons and turns it off at 2000 gallons. lights up to show relay 2 is energized. The indicates level is rising.

With the Pump Alternation feature activated, the next time the level reaches 6000 gallons, relay #1 transfers and starts the backup pump. lights up to show relay 1 is on.

3

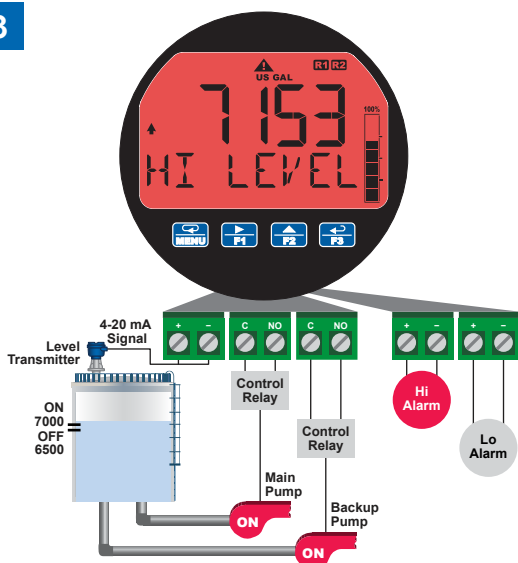

If the backup pump is not able to keep up, and the level reaches 7000 gallons, relay #2 transfers and starts the main pump as well. Open collector #1 trips the High Level Alarm, the display turns red and flashes "Hi Level" message, and indicates an alarm condition. The High Level Alarm resets at 6500 gallons.

4

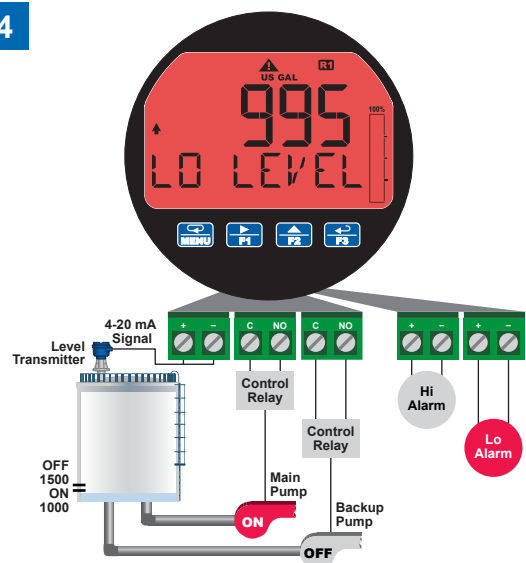

Once the level has dropped below the reset points, both relays will turn off. If the Main Pump fails to turn off, open collector #2 trips the Low Level Alarm at 1000 gallons to warn against the pump running dry. The Low Level Alarm resets at 1500 gallons.

INPUT SIGNAL CONDITIONING

To satisfy applications that require scaling in ways other than the usual 2-point linear method, the meter can also be scaled for square root (DP flow), programmable exponent (open channel flow) or round horizontal tank volume calculation.

For existing processes that require these linearization capabilities, one of the great benefits of loop-powered meters is that they get their power directly from the 4-20 mA loop and thus require no additional wiring. All a user has to do is break the existing loop and wire in the meter. For this reason, loop-powered meters are very easy to add to existing applications such as DP flow, open channel flow, or round horizontal tank volume calculation.

Round Horizontal Tank Linearization

This function automatically calculates the volume in a round horizontal tank with flat ends.

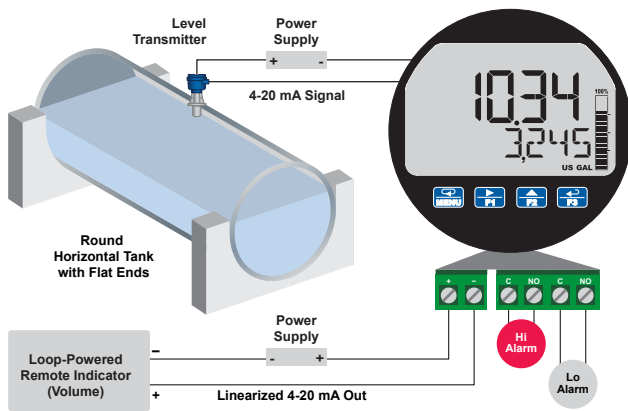

Programmable Exponent Linearization

The programmable exponent can be used to linearize the signal from level transmitters in open-channel flow applications using weirs and flumes.

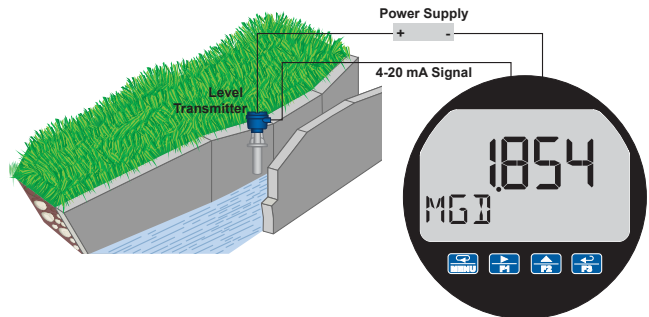

Square Root Linearization

The square root function can be used to linearize the signal from a differential pressure transmitter and display flow rate in engineering units. The meters in this data sheet will display flow rate only. To display both flow rate and total use the PD6928.

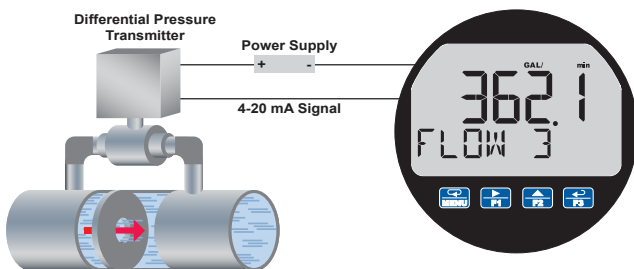

Multi-Point Linearization

Meters are set up at the factory for linear function with 2-point linearization. Up to 32 linearization points can be selected for the scaled value under the linear function. Multi-point linearization can be used to linearize the input so the meter can display volume from non-linear tanks or to convert level to flow using weirs and flumes with complex equations.

MeterView XL makes it easy to program up to 32 points.

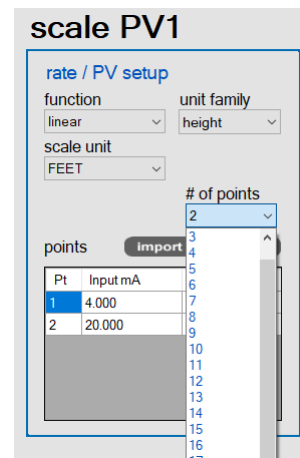

PHYSICAL FEATURES

ProtEX+ Aluminum & Stainless Steel Enclosures



VantageView+ Plastic Enclosure



NEMA 4X Enclosures

Both ProtEX+ and VantageView+ enclosures provide serious protection from the elements, high impact, corrosion, and dust. The ProtEX+ is NEMA 4X/IP68 rated, and VantageView+ is NEMA 4X/IP66. In addition, the ProtEX+ enclosure provides protection against electrical interference and its extensive worldwide agency approvals allow it to be installed virtually anywhere.



Easy Pipe Mounting

Both ProtEX+ and VantageView+ come with a built-in flange. This allows easy mounting to walls or pipes using either a [PDA6846](#) Zinc Plated Steel or a [PDA6846-SS](#) Stainless Steel 2" U-Bolt Kit. A slot on the back of the enclosure makes it easy to center the unit on a pipe.

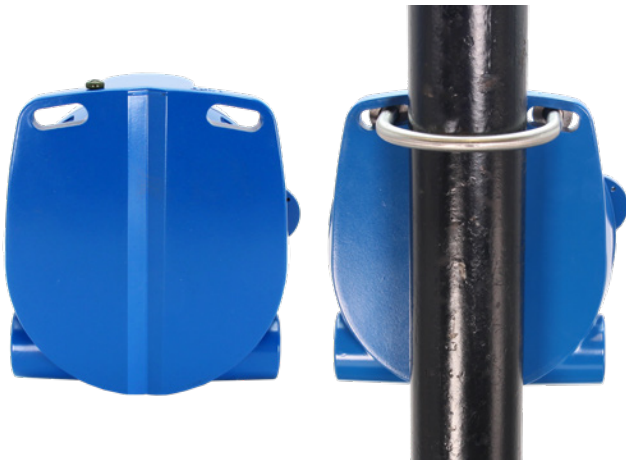

Stainless Steel Tag Attaching Loop

The enclosure is equipped with a loop at the top to easily attach a PDA-SSTAG stainless steel tag.



Tamper-Proof Capability

The instrument can be made tamper-proof by inserting a wire through the built-in loop on the base of the enclosure and a hole in the lid of the enclosure and securing this wire with a lead seal.



Rotatable Display Module

The display module can be rotated in 90° increments providing added mounting flexibility. Plus the various conduit connections allow a variety of installation options.



Wide Viewing Angle

The window and display module have been optimized to provide a wide viewing angle of approximately ±40°; nearly twice that of the competition.



Easy Wiring & Service

Both ProtEX+ and VantageView+ have been designed for easy wiring and servicing. All connections are made to removable screw terminal blocks. There are no exposed printed circuit boards. The display module snaps into the built-in rails on the enclosure ensuring a secure and perfect fit every time. No tools are needed to install or remove it. The options module is screwed into the base of the enclosure. Both modules completely encase the printed circuit boards.



Options Board (Left) and Display Module (Right)

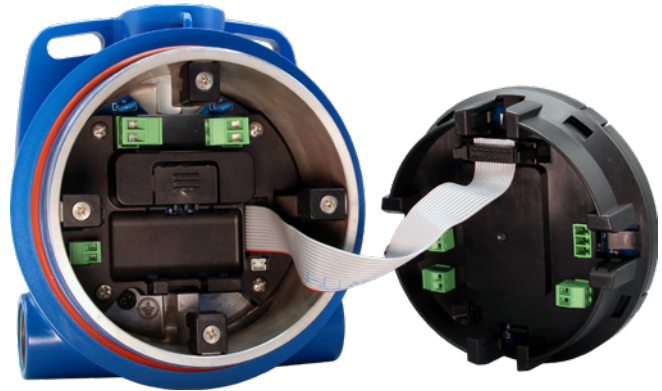

Options Board Connected to Display Module

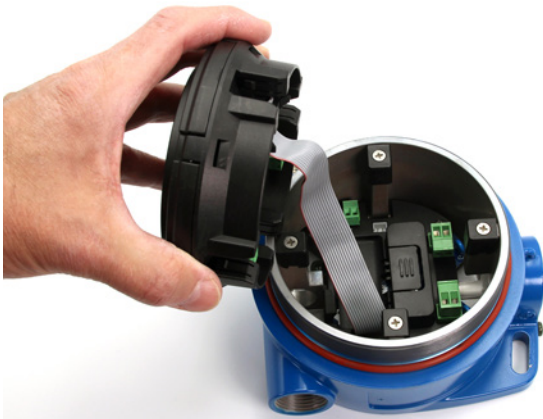

Options Board Mounted on the Bottom of Enclosure



Display Module Mounted on Built-In Rails

USB Port for Easy Connection to Free MeterView XL Software



Two Threaded Conduit Openings

The ProtEX+ comes with two 3/4" NPT threaded conduit openings as standard. It also available with M20 conduit openings as an option. The VantageView+ comes with three 3/4" NPT threaded conduit openings and two conduit plugs included.

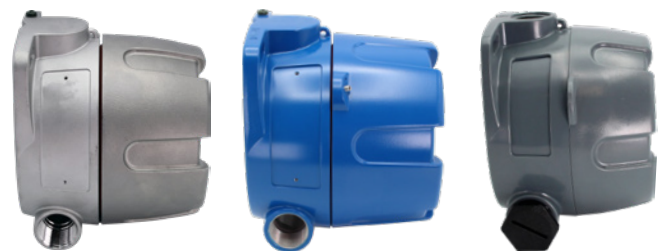



OPERATIONAL FEATURES

There are two ways the user can interact with the ProtEX+ and VantageView+ to perform a variety of useful functions: programmable function keys and the digital input.

Programmable Function Keys

The three CapTouch buttons labeled F1, F2, and F3 can be programmed as function keys to perform a variety of meter functions simply by pressing on the window over the button. These include operation of the tare function, resetting the tare, resetting the meter's relays or open collectors, starting and stopping timers, and displaying max/min values. The default settings for the function keys are:

Button	Description (Default Settings)
 F1	Press to display max/min readings.
 F2	Press to reset max/min readings.
 F3	Press to acknowledge all manually resettable relays or open collectors. Press to lock/unlock the display value after pressing the F1 key.

For a complete list of Function Keys settings, see *Function Keys & Digital Input Available Settings* on the next page.

On-Board Digital Input

A digital input is standard on both ProtEX+ and VantageView+ meters. This digital input is programmed identically to the function keys. The input is triggered with a contact closure between DI+ and DI-, or with an active low signal. For a complete list of Digital Input settings, see *Function Keys & Digital Input Available Settings* on the next page.

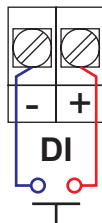

Remote Operation of VantageView+

The VantageView+ digital input can be connected to a [PDA2360](#) single button remote control station as illustrated below and be programmed to perform various functions. Common uses for this digital input would be for resetting the meter's relays or open collectors, starting and stopping timers, and displaying max/min values. For a complete list of Digital Input settings, see *Function Keys & Digital Input Available Settings* on the next page.

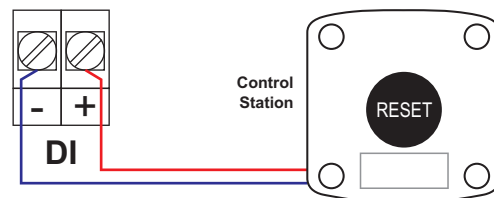

Available Single Button Control Stations



PDA2360-E



PDA2361-A



PDA2361-B



PDA2361-R



PDA2361-T



PDA2361-S



PDA2361-Q

WARNING

- Control Stations do not carry hazardous area approvals and are thus not suitable for location in hazardous areas.

Function Keys & Digital Input Available Settings

The following table describes the actions that the ProtEX+ and VantageView+ function keys and digital input can perform.

Display	Description
DISP FN	Set the function key or digital input to display a value
DISPLAY	Cycle max, min, and PV(s)
DISP PV	Display the PV
PCT PV	Display the PV's percentage of max (20 mA)
UNITS	Display the PV's units
TAG	Display the PV's tag
DISPMIN	Display the PV's minimum
DISPMAX	Display the PV's maximum
MIN MAX	Display the PV's minimum and maximum value
mA IN	Display the mA input value
mAOUT	Display the mA output value
MENU FN	Set the function key or digital input to access a menu
RLYINFO	Go to relay information menu (INFO)
MANCTRL	Go to output control menu (CONTROL)
TIMR OC1	Open collector 1 timer
TIMR OC2	Open collector 2 timer
TIMER R1	Relay 1 timer
TIMER R2	Relay 2 timer
TIMERFN	Set the function key or digital input to start or stop a timer
STARTALL	Start all timers
STOPALL	Stop all timers
SSTPALL	Start or stop all timers
OC1	Start/stop open collector 1 timer
OC2	Start/stop open collector 2 timer
RLY1	Start/stop relay 1 timer
RLY2	Start/stop relay 2 timer
START	Start the selected timer output
STOP	Stop the selected timer output
STR--STP	Start or stop the selected timer output

Display	Description
ALARMFN	Set the function key or digital input to acknowledge an alarm
ACK	Acknowledge all active alarms
SETPOINT	Set all output set point
SETPT,OC1	Set open collector 1 set point
SETPT,OC2	Set open collector 2 set point
SETPT,R1	Set relay 1 set point
SETPT,R2	Set relay 2 set point
SWATCHFN	Set the function key or digital input to activate stopwatch
START	Start the stopwatch
STOP	Pause/Stop the stopwatch
STR--STP	Start or stop the stopwatch
TAREFN	Set the function key or digital input to tare the display value
TARE	Tare the display value
RST TARE	Reset the display value
HOLD FN	Set the function key or digital input to hold an output
HOLD,OUT	Hold all outputs
HL,UNHL	Hold or un-hold all outputs
OC 1+2	Hold/un-hold open collector outputs
RLY 1+2	Hold/un-hold relay outputs
mAOUT	Hold/un-hold 4-20 mA output
HOLD	Hold selected output
HL,UNHL	Hold or un-hold selected output
DISABLE	Disable the function key or digital input
RST FN	Set the function key or digital input to reset a value
RESET	Reset min, max, or max/min PV value
R MINMAX	Reset max and min PV value

METERVIEW XL PROGRAMMING SOFTWARE

Free, PC-based, MeterView XL software that connects to the meter via a micro USB cable is available for programming and setup of the meters. This software greatly simplifies the programming process and also allows the user to save configuration files for later use. The meter will also be powered by the USB connection so no additional power is needed during programming.

For more information visit
www.predig.com/meterviewxl

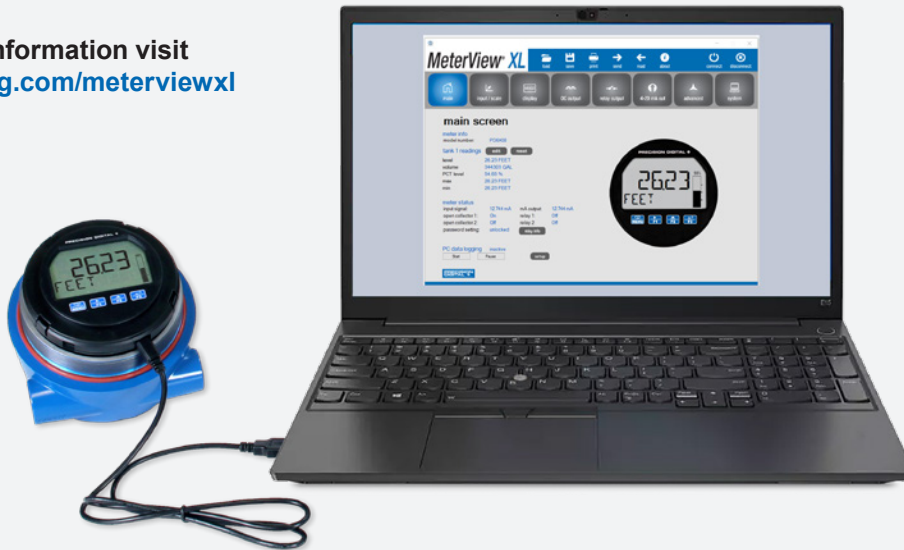

WARNING

- The meter should only be connected to a computer while it is located in a safe area.

Main Screen

The main screen displays an image of the connected meter and includes various information about this meter, such as model number, readings, and status.

Input/Scale

The Input/Scale window is used to set the input, scale the input, and enable/disable the dual-scale feature.

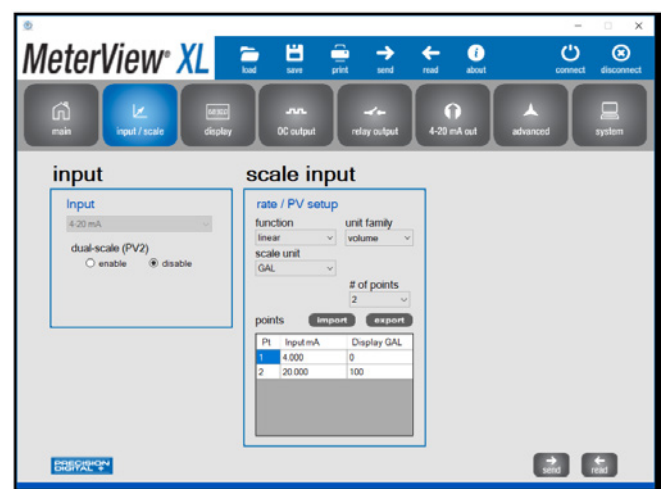
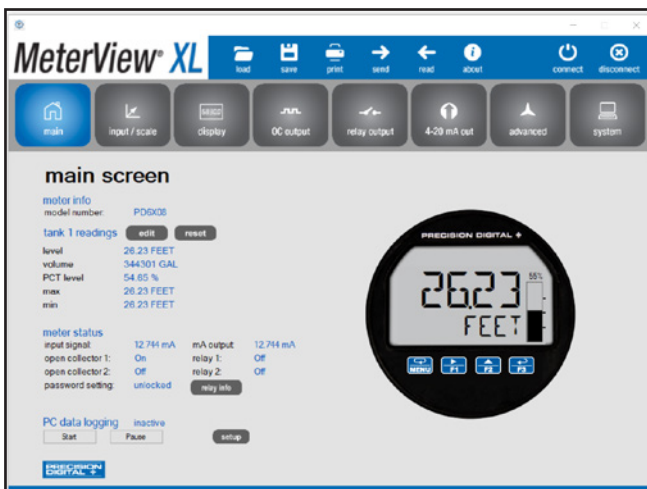

Relay Output

The Relay Output window is used to assign a specific task to the 2 relays such as alarm, sample, timer, stopwatch, or off. A custom message that flashes every 10 seconds can also be added.

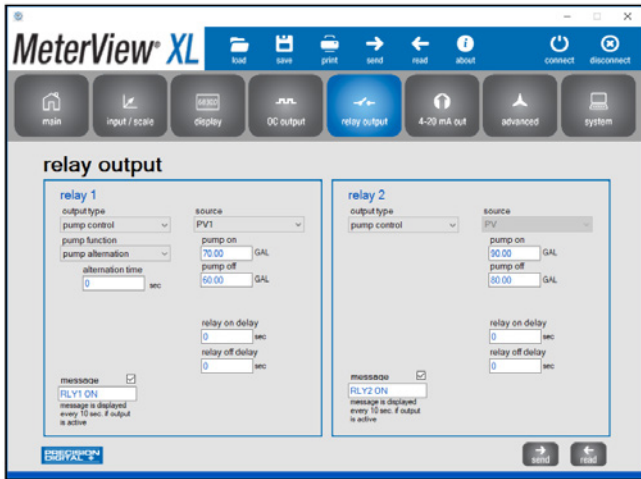

4-20 mA Output

The 4-20 mA Output window is used to program the isolated 4-20 mA output's source, range, and under and over range values.

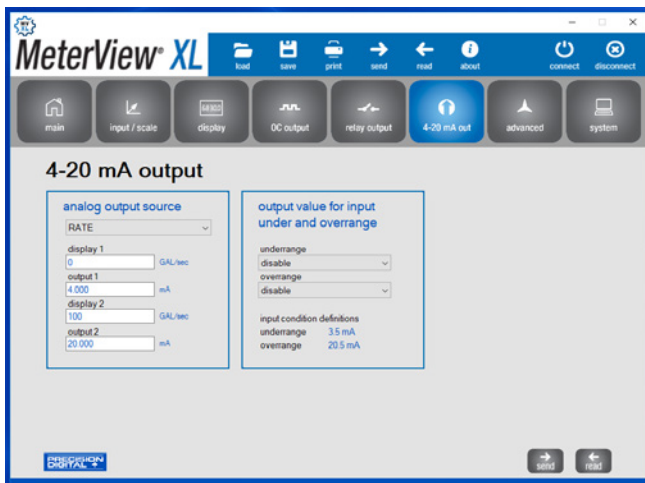

Data Logging

MeterView XL software, when connected to the meter, can generate a log file such as the following example.

Date & Time	PV1	units	PV1 percent units
2/22/2021 12:31	0.017	FEET	0.43 %
2/22/2021 12:32	0.125	FEET	3.13 %
2/22/2021 12:32	0.231	FEET	5.78 %
2/22/2021 12:32	0.34	FEET	8.51 %
2/22/2021 12:32	0.446	FEET	11.15 %
2/22/2021 12:33	0.552	FEET	13.8 %
2/22/2021 12:33	0.659	FEET	16.47 %
2/22/2021 12:33	0.765	FEET	19.12 %
2/22/2021 12:33	0.871	FEET	21.78 %
2/22/2021 12:34	0.98	FEET	24.5 %
2/22/2021 12:34	1.086	FEET	27.14 %
2/22/2021 12:34	1.192	FEET	29.8 %
2/22/2021 12:35	1.299	FEET	32.48 %
2/22/2021 12:35	1.406	FEET	35.14 %
2/22/2021 12:35	1.51	FEET	37.76 %
2/22/2021 12:35	1.616	FEET	40.41 %
2/22/2021 12:36	1.726	FEET	43.15 %
2/22/2021 12:36	1.83	FEET	45.76 %
2/22/2021 12:36	1.937	FEET	48.42 %
2/22/2021 12:36	2.042	FEET	51.05 %
2/22/2021 12:37	2.148	FEET	53.71 %
2/22/2021 12:37	2.257	FEET	56.43 %
2/22/2021 12:37	2.364	FEET	59.1 %
2/22/2021 12:38	2.47	FEET	61.75 %
2/22/2021 12:38	2.579	FEET	64.48 %
2/22/2021 12:38	2.681	FEET	67.03 %
2/22/2021 12:38	2.788	FEET	69.71 %

Configuration Files

A configuration file can be generated with or without a meter connected to the PC. This makes it possible to prepare meter configurations prior to having the meter in hand. Meter configurations can be saved and re-loaded into other meters. Meter configurations can also be printed.

ACCESSORIES

PDA6846 2" U-Bolt Kits



The PDA6846 U-Bolt Kits provide a convenient way to mount the meter to 1.5" or 2" pipes. They are available in steel and stainless steel.

Model	Description
PDA6846	2" Zinc Plated Steel U-Bolt Kit with One U-Bolt
PDA6846-SS	2" Stainless Steel U-Bolt Kit with One U-Bolt

PDA-SSTAG Stainless Steel Tag



The PDA-SSTAG is a laser etched stainless steel tag that can be customized with three lines of text. Each tag comes with a stainless steel wire and lead seal for easy mounting wherever you need.

Model	Description
PDA-SSTAG	Stainless Steel Tag

24 VDC Transmitter Power Supply



The [PDA1024-01](#) 24 VDC power supply can be used for a variety of functions like powering 4-20 mA transmitters. It can be mounted on a [PDA1002](#) DIN rail.

Model	Description
PDA1024-01	24 VDC Transmitter Power Supply
PDA1002	6" DIN Rail Mounting Kit

Specifications

Input Voltage	85-264 VAC; 120-370 VDC
Output Voltage	21.6-29 VDC; 1.5 A rated current.
Input Frequency	47-63 Hz
AC Current	115 VAC: 0.88 A; 230 VAC: 0.48 A
Connections	Screw terminals
Overload Protection	105-160% rated output power. Constant current limiting, recovers automatically after fault condition is removed
Operating Temperature	-30 to 60°C (-22 to 140°F)
Vibration	10-500 Hz, 2G 10 min./1 cycle, period for 60 min. each along X, Y, Z axes
Safety Standards	UL 508 Listed and UL Recognized Component
Dimensions	1.40" x 3.50" x 2.10" (35 mm x 90 mm x 54.5 mm) (W x H x D)
Warranty	1 year parts & labor

WARNING

- PDA1024-01 does not carry hazardous area approvals and is thus not suitable for location in hazardous areas. The use of additional protective devices may allow it to be installed in a safe area and connected to a device in a hazardous area. User should consult a professional engineer to determine suitability of these products for their specific application.

Plugs



PDAPLUG75 3/4" NPT 316 stainless steel stopping plug with approvals is available for ProtEX+ meters. PDAPLUG75P 3/4" NPT plastic conduit plug is available for VantageView+ meters.

Model	Description
PDAPLUG75	3/4" NPT 316 Stainless Steel Stopping Plug with Approvals for ProtEX+
PDAPLUG75P	3/4" NPT Plastic Conduit Plug for VantageView+

Reducers



The following reducers are available for ProtEX+ meter.

Model	Description
PDAREDUCER-75M-50F	M-3/4" NPT to F-1/2" NPT Reducer with Approvals
PDAREDUCER-75M-M20F	M-3/4" NPT to F-M20 Reducer with Approvals

Plastic Control Stations

The PDA2360 series of plastic control stations provide a convenient way to remotely control devices. The VantageView+ digital input can be wired to any of the following control stations to perform a single task.

Model	Description
PDA2360-E	Emergency Button
PDA2361-A	Ack Button
PDA2361-B	Blank Button
PDA2361-R	Reset Button
PDA2361-T	Tare Button
PDA2361-S	Stop Button
PDA2361-Q	Silence Button

Notes:

- Control stations can be connected directly to the meter's Digital Input terminals labeled DI+ and DI-.



PDA2360-E



PDA2361-A



PDA2361-B



PDA2361-R



PDA2361-T



PDA2361-S



PDA2361-Q

⚠ WARNING

- Control Stations do not carry hazardous area approvals and are thus not suitable for location in hazardous areas. The use of additional protective devices may allow them to be installed in a safe area and connected to a device in a hazardous area. User should consult a professional engineer to determine suitability of these products for their specific application.

PD9501 Multi-Function Calibrator



This PD9501 Multi-Function Calibrator has a variety of signal measurement and output functions, including voltage, current, thermocouple, and RTD.

Model	Description
PD9501	Multi-Function Calibrator

Signal Splitter & Conditioner Accessories



The PD659 series includes DIN rail mountable models for signal isolation, splitting and conditioning of 4-20 mA and 0-10 VDC signals.

Model	Description
PD659-1MA-1MA	Signal Isolator with One 4-20 mA Input and One 4-20 mA Output
PD659-1MA-2MA	Signal Splitter with One 4-20 mA Input and Two 4-20 mA Outputs
PD659-1V-1MA	Signal Conditioner with One 0-10 VDC Input and One 4-20 mA Output
PD659-1MA-1V	Signal Conditioner with One 4-20 mA Input and One 0-10 VDC Output

PD9502 Low-Cost Signal Generator



The PD9502 is a low-cost, compact, simple to use 4-20 mA or 0-10 VDC signal generator. It can easily be set for 0-20 mA, 4-20 mA, 0-10 V or 2-10 V ranges. Signal adjustment is made with a one-turn knob. A wall plug is provided with the instrument. Optional USB power bank is available.

Model	Description
PD9502	Low-Cost Signal Generator
PDA1001	USB Power Bank

WARNING

- These accessories do not carry hazardous area approvals and are thus not suitable for location in hazardous areas. The use of additional protective devices may allow them to be installed in a safe area and connected to a device in a hazardous area. User should consult a professional engineer to determine suitability of these products for their specific application.

Complete Product Line of Loop-Powered Meters

WITH ALL THE SAME FEATURES & FUNCTIONALITY



2 Open Collector
Outputs



2 Solid-State
Relays



4-20 mA
Output



Two-Color
Backlight

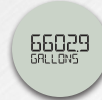

Dual-Line
Displays



Pump
Control



Batch
Control



Ex CE IECEx

LARGE DISPLAY ❖

PD4 Loop Leader+ Series

- NEMA 4X, IP65 Rated Wall-Mount Enclosures
- Large 5-Digit, 2.8" High Top Display
- Safe Area and I.S. Models
- ATEX and IECEx Certified



Ex CE IECEx

EXPLOSION-PROOF ❖

PD6900 ProtEX+ Series

- NEMA 4X, IP68 Rated Aluminum and Stainless Steel Enclosures
- CapTouch Through-Glass Buttons
- Explosion-Proof & I.S.
- CSA, ATEX, and IECEx Certified



UL LISTED Ex CE IECEx

1/8 DIN PANEL MOUNT ❖

PD6600 Loop Leader Series

- NEMA 4X, IP65 Rated Front 1/8 DIN Panel Mount Meters
- General Purpose and I.S. and N.I. Models
- UL, C-UL, and CE Approved

VantageView+ CE

FIELD-MOUNT ❖

PD6900 VantageView+ Series

- NEMA 4X, IP66 Rated Plastic Enclosure
- CapTouch Through-Window Buttons
- General Purpose



MeterView XL Software Programs All These Products

Go to PREDIG.COM for details

DIMENSIONS

ProtEX+

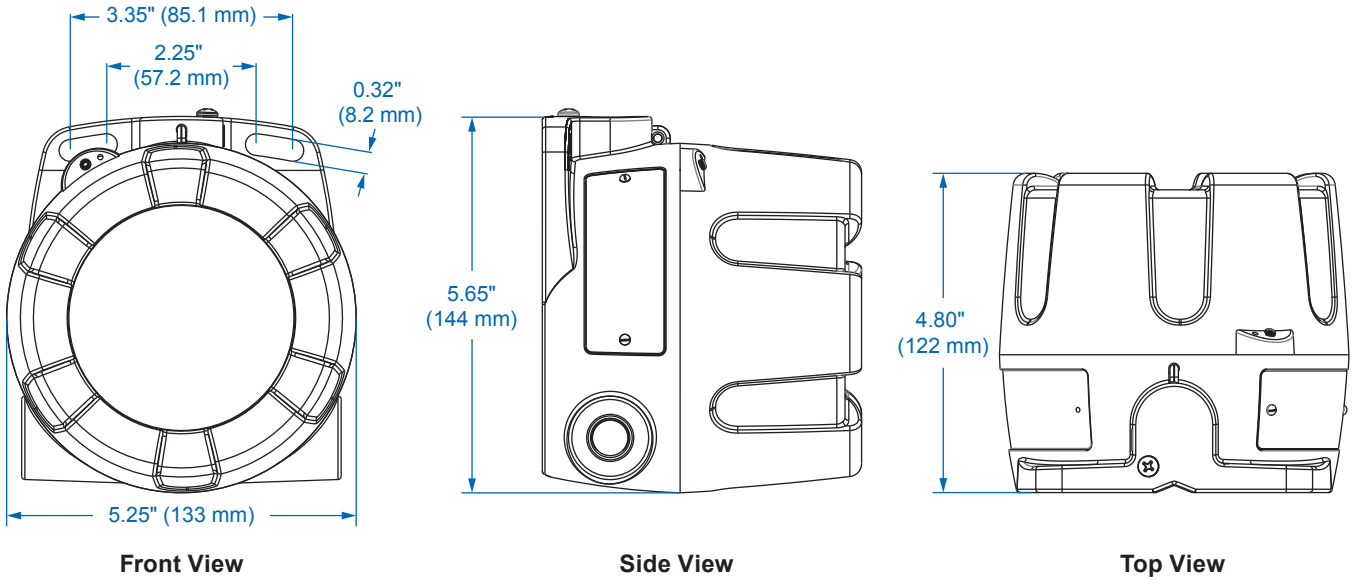

VantageView+

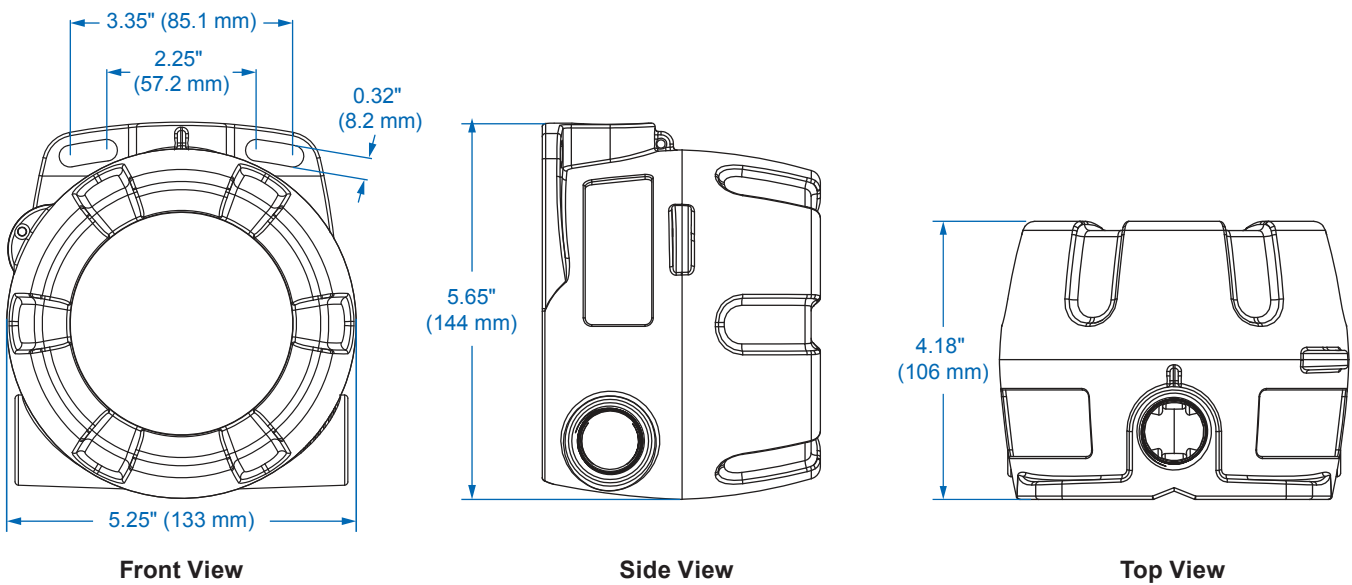

Download free 3-D CAD files of these instruments to simplify your drawings!

predig.com/documentation-cad

CONNECTIONS

Connectors Labeling

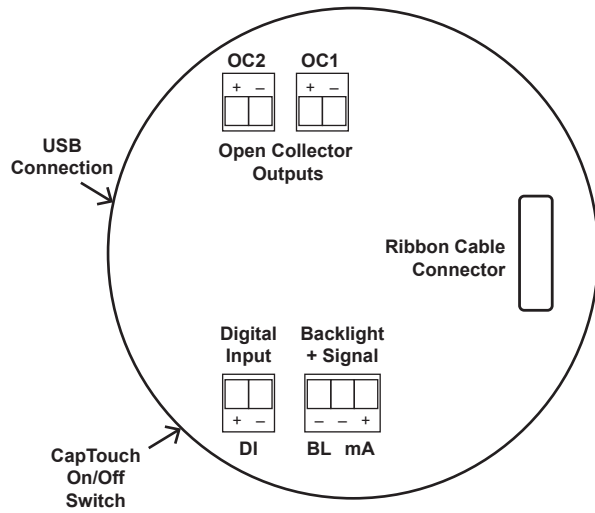

-LNN Base Meter (2 Open Collectors Standard)

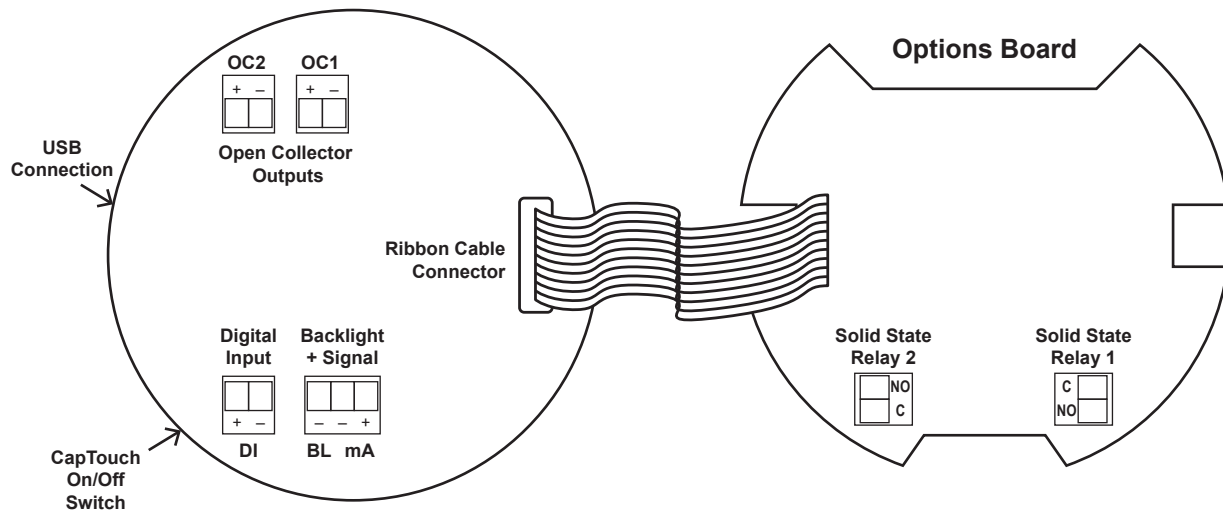

-L2N Option (2 Solid-State Relays)

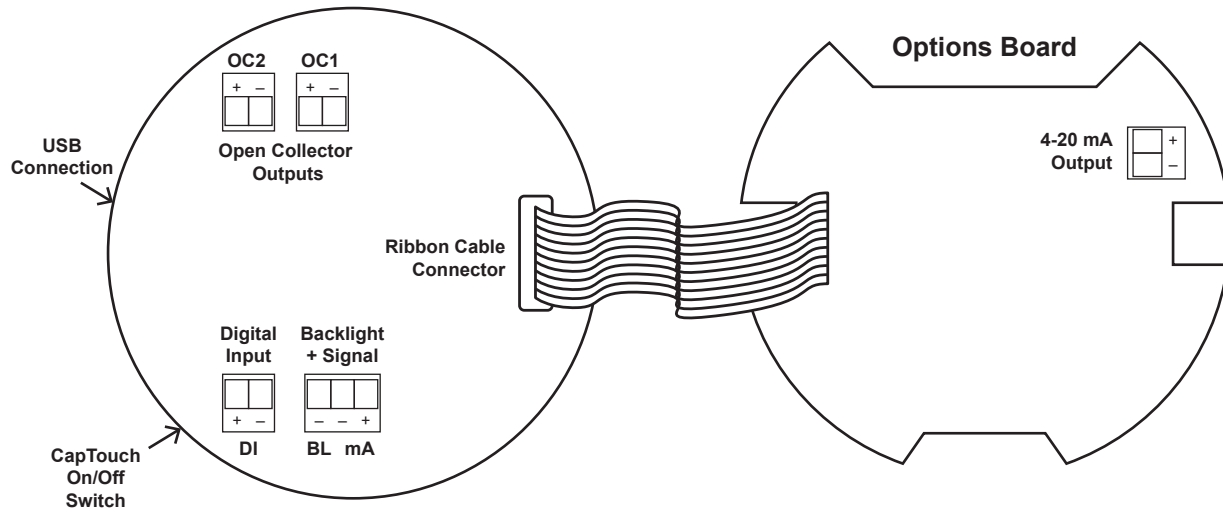

-L3N Option (4-20 mA Output)

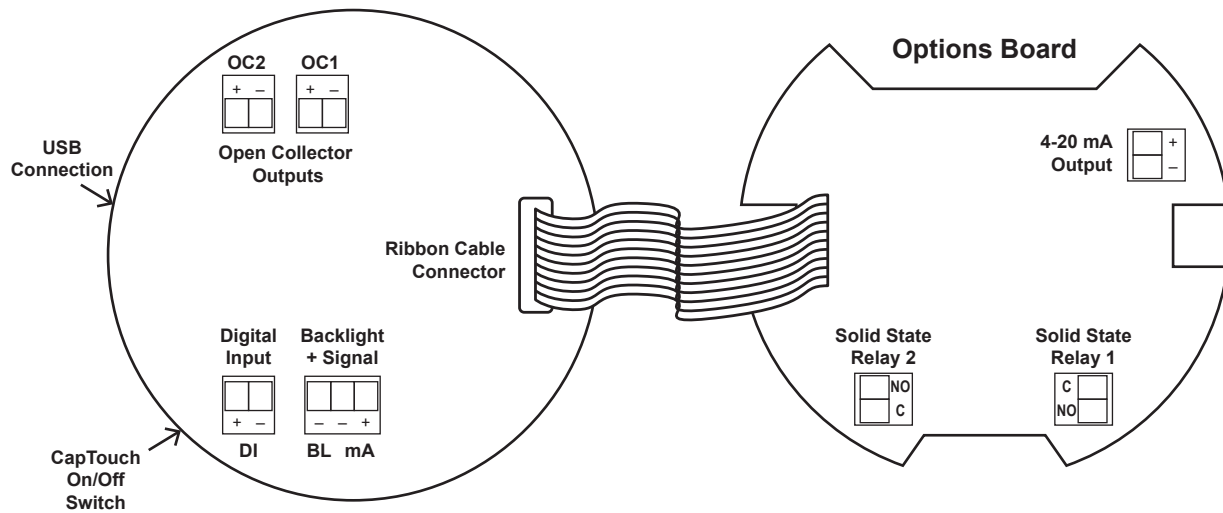

-L5N Option (2 Solid-State Relays and 4-20 mA Output)

WIRING DIAGRAMS

For existing applications, one of the great benefits of loop-powered meters is that they get their power directly from the 4-20 mA loop and thus require no additional wiring. All a user has to do is break the existing loop and wire in the meter.

⚠ WARNING

- See Control Drawing [LIM6908-2](#) for information on hazardous area wiring.

Input Loop (4-20 mA) Connections

The following figures show a 4-20 mA loop connected to the meter. The first figure shows the connection without the backlight and the second shows the connection with the backlight. The meter is powered by the 4-20 mA current loop.

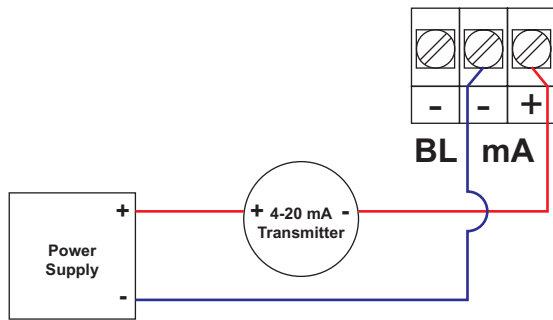

4-20 mA Input Connection without Backlight

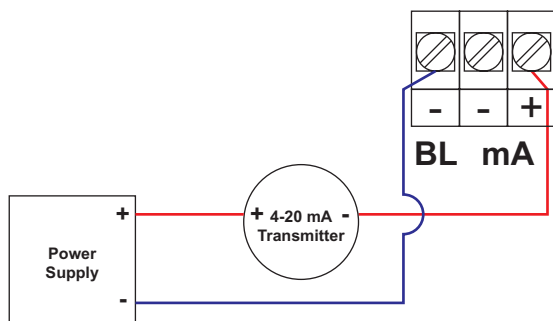

4-20 mA Input Connection with Backlight

Digital Input Connections

A digital input is standard on the meter. This digital input is connected with a normally open contact across DI+ and DI-, or with an active low signal applied to DI+ and DI-.

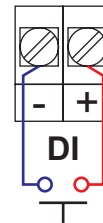

4-20 mA Output Connections

Connections for the 4-20 mA transmitter output are made to the connector terminals labeled mA OUT. The 4-20 mA output must be powered from an external power supply.

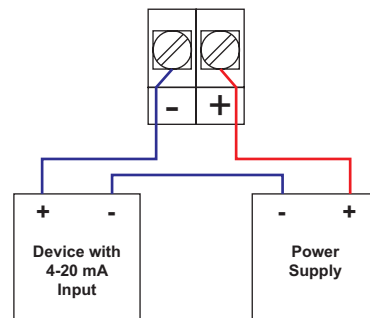

Solid-State Relay Connections

Relay connections are made to two-terminal connectors. Each relay's C terminal is common only to the normally open (NO) contact of the corresponding relay.

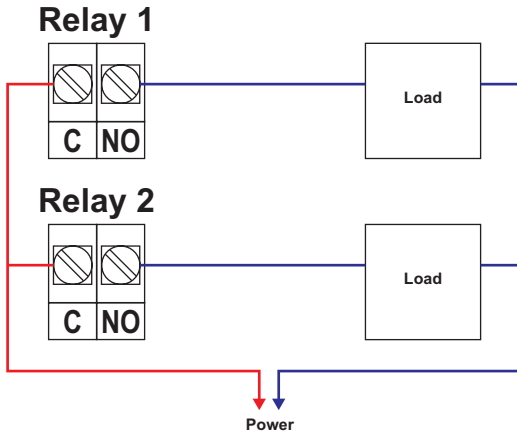

Open Collector Outputs

Open collector output 1 and 2 connections are made to terminals labeled O1+ and O1-, and O2+ and O2-. Connect the alarm or pulse input device as shown below.

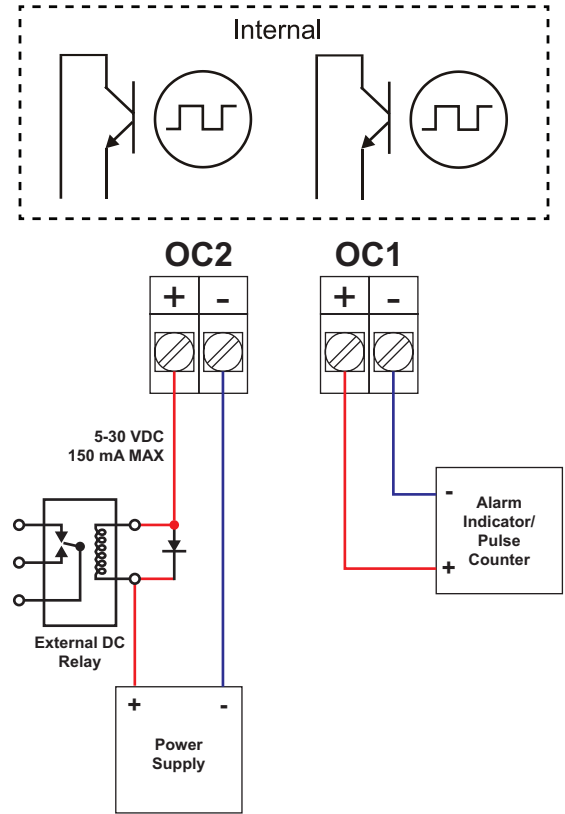

SPECIFICATIONS

Except where noted all specifications apply to operation at +25°C.

Display

PD6907	Dual-line LCD with backlight. Top: 0.7" (17.8 mm) 5 digits, 7-segment, FT-IN & fractions. Bottom: 0.4" (10.2 mm), 8 alphanumeric 14-segment characters. Display may be programmed to turn red and flash a user-defined message on alarm condition.
PD6908	Dual-line LCD with backlight. Both lines alphanumeric. Top: 0.7" (17.8 mm) 5 digits, 12-segment Bottom: 0.4" (10.2 mm) 8 characters, 14-segment Display may be programmed to turn red and flash a user-defined message on alarm condition.
Backlight	Powered by 4-20 mA loop. Intensity varies with signal level.
Top Display	PD6907: FT - IN/*: Automatically reducing fractions to lowest denominator *FT-IN/16, FT-IN/8, FT-IN/4, FT-IN/2, FT-IN -99FT 11IN 15/16 to 999FT 11IN 15/16 PD6908: 5 digits (-9999 to 99999) or 5 characters (all capital & most lower-case letters)
Bottom Display	8 digits (-9,999,999 to 99,999,999; separated by commas) or 8 characters (all capital & most lower-case letters)
Bargraph	20 segments. Numeric percent indication at top (PD6907 only)
Decimal Point	Up to four decimal places on top display and up to seven decimal places on bottom display
Commas	Commas to indicate 1000s (e.g. 88,987,628) on bottom display only
Dual-Scale Feature	The input can be displayed in different scales on the top and bottom displays. For instance, the top display could display the input in height and the bottom display could display that same input in volume.
Alarm Indication	Programmable: loop-powered red backlight, flashing display, alarm symbol ▲, bargraph segment flashes on alarm.
Custom Alarm Messages	Programmable for each relay/open collector: 8 characters maximum; displayed every 10 sec for 1 sec on bottom display. May be turned off.
Display Update Rate	Ambient > -10°C: 1 Update/Second Ambient = -20°C: 1 Update/2 Seconds From -20°C to -40°C the update rate slows down 1 second for every -2°C (e.g. at -24°C, 1 update/4 seconds).
Overrange	PD6907: Top: 999 11 15/16 PD6908: Top: 99999 Bottom: 99,999,999 (flashing)
Underrange	PD6907: Top -99 11 15/16 PD6908: Top: -9999 Bottom: -9,999,999 (flashing)

General

Programming Method	Four CapTouch through-window buttons when cover is installed. The CapTouch buttons can be used with the cover removed. Free PC-based USB MeterView XL programming software.
Environmental	Operating temperature range: -40 to 75°C (-40 to 167°F) Storage temperature range: ProtEX+: -55 to 85°C (-67 to 185°F) VantageView+: -40 to 85°C (-40 to 185°F) Installation temperature range: ProtEX+: -55 to 75°C (-67 to 167°F) (The display ceases to function, however inputs and outputs continue to operate) VantageView+: -40 to 75°C (-40 to 167°F) Relative humidity: 0 to 90% non-condensing Printed circuit boards are conformally coated
Noise Filter	Averages the input signal over a period of time between 1 and 16 seconds to dampen the effects of a noisy signal that causes a jumpy display.
Filter Bypass	0.0 to 99.9% of full scale. Input signal changes greater than bypass value are displayed immediately.
Recalibration	Recalibration is recommended at least every 12 months.
Max/Min Display	Max/min readings reached by the process are stored until reset by the user or until power to the meter is turned off.
Tare	Tare function zeros out the meter to accommodate for weight of a container. Tare function can be assigned to a function key or the digital input.
Password	Programmable password restricts modification of programmed settings.
Non-Volatile Memory	All programmed settings are stored in non-volatile memory for a minimum of ten years if power is lost.
Normal Mode Rejection	64 dB at 50/60 Hz
Connections	Removable screw terminal blocks Display terminals: accept 16 to 30 AWG wire Relay terminals: accept 12 to 26 AWG wire 4-20 mA output: accept 16 to 30 AWG wire
Tightening Torque	Display terminals: 2.5 lb-in (0.28 Nm) Relay terminals: 4.5 lb-in (0.5 Nm) 4-20 mA output terminals: 2.5 lb-in (0.28 Nm)
Overall Dimensions	ProtEX+: 5.25" x 5.65" x 4.80" (133 x 144 x 122 mm) (W x H x D) VantageView+: 5.25" x 5.65" x 4.18" (133 x 144 x 106 mm) (W x H x D)
Weight	ProtEX+: Aluminum: 5.1 lbs (2.3 kg); Stainless Steel: 9.4 lbs (4.3 kg) VantageView+: 1.9 lbs (0.9 kg)
Warranty	3 years parts and labor. See Warranty Information and Terms & Conditions on www.predig.com for complete details.

Enclosure

Material	ProtEX+ -AL Models: ASTM A413 LM6 die-cast aluminum, copper-free, enamel coated ProtEX+ -SS Models: ASTM A743 CF8M investment-cast 316 stainless steel VantageView+ -PL Models: Polycarbonate plastic with UV stabilizer
Gasket	ProtEX+ Models: Fluoroelastomer VantageView+ Models: Buna-N
Rating	-AL/-SS: NEMA 4X, IP68 Explosion-proof -PL: NEMA 4X, IP66 plastic, UL 94V-0
Color	-AL: Blue; -SS: Silver; -PL: Grey
Window	-AL/-SS: Borosilicate glass -PL: Clear polycarbonate with UV stabilizer
Conduits	-AL/-SS: Two ¾" NPT threaded conduit openings. M20 conduits are available. See Ordering Information for details. -PL: Three ¾" NPT threaded conduit openings
Conduit Stopping Plug	-AL/-SS: Sold separately -PL: Two ¾" NPT plastic conduit plugs with 1.29" wrenching flats and a screwdriver slot are included
Flange	Built-in flange for wall and pipe mounting.
Tamper-Proof Seal	Cover may be secured with tamper-proof seal.
Instrument Tag Loop	Built-in loop for securing stainless steel tag
ATEX & IECEx (ProtEX+ enclosure only)	Flameproof Ⓜ II 2GD Ex db IIC Gb Ex tb IIIC Db IP66/IP68 Tamb: -55°C to +85°C Certificate No.: Sira 19ATEX1252U Certificate No.: IECEx SIR 19.0075U
CSA (ProtEX+ enclosure only)	Class I, Division 1, Groups A, B, C, D Class II, Division 1, Group E, F, G Class III Ex db IIC Gb Ex tb IIIC Db Class I, Zone 1, AEx db IIC Gb Zone 21, AEx tb IIIC Db IP66/IP68/TYPE 4X Tamb: -55°C to +85°C Certificate No.: 80011200
UL (ProtEX+ enclosure only)	Class I, Division 1, Groups A, B, C, D Class II, Division 1, Groups E, F, G Class III Class I, Zone 1, AEx db IIC Gb Zone 21, AEx tb IIIC Ex db IIC Gb Ex tb IIIC Db IP66/IP68/TYPE 4X Tamb: -55°C to +85°C Certificate Number: E518920

Note: The above approvals are for the enclosure only. See *Compliance Information* for approvals on the entire instrument.

Input

Input	4-20 mA
Accuracy	±0.02% of span ±1 count PD6908: Square root and programmable exponent: 10-100% FS
Voltage Drop	Without Backlight: 1.5 V maximum, With backlight: 4.7 V maximum
Equivalent Resistance	With backlight off: 75 Ω @ 20 mA With backlight on: 235 Ω @ 20 mA
Input Overload	Over current protection to 1 A maximum Over voltage protection to 30 VDC max (between mA+ and mA-/BL-)
Temperature Drift	25 PPM/°C from -40 to 75°C ambient
Function	PD6908: PV1: Linear (2-32 points), square root, or programmable exponent PV2: Linear (2-32 points) or Round Horizontal Tank PD6907: PV1: Linear (2-32 points) PV2: Linear (2-32 points) or Round Horizontal Tank
Low-Flow / Low-Height Cutoff	Point below at which the display always shows zero. PD6908: 0.1 to 999,999 or disable. PD6907: 1/16 to 999FT 11IN 15/16 or disable.
HART Transparency	The meter does not interfere with existing HART communications; it displays the 4-20 mA primary variable and it allows the HART communications to pass through without interruption. The meter is not affected if a HART communicator is connected to the loop. The meter does not display secondary HART variables.

MeterView XL

Availability	Free download from www.predig.com
System Requirements	Microsoft® Windows® 7 & 10
Communications	USB 2.0 (Standard USB A to Micro USB B) Cable provided
Configuration	Configure all parameters on the meter. Configure meters one at a time.
Configuration Files	Generate with or without meter connected; Save to file for later use.
USB Power Connection	Meter is powered by USB connection during programming, if 4-20 mA loop is not connected.

WARNING

- The meter should only be connected to a computer while it is located in a safe area.

Compatibility	Programs created for Loop Leader and Loop Leader+ may be run on either meter. Programs created for VantageView+ and ProtEX+ can be run on either meter. No other program sharing is permissible.
----------------------	--

Common Open Collector & Relay Specifications

Number	Two open collectors & two relays
High or Low Alarm	User programmable for high or low alarm
Alarm Deadband	0-100% FS, user programmable
Output Assignment	Alarm, Timer, Stopwatch, or Disable
Alarm Output Source	Assign to PV (PV1, PV2) or Digital Input
On & Off Time Delay	0 to 9,999 seconds
Fail-Safe Operation	Independent for each open collector and relay. Fail-safe on, the output is on under normal conditions. Fail-safe off, the output is on under alarm conditions.
Alarm Operation	Automatic, automatic with manual override, latching (manual reset anytime), latching with reset after cleared (manual reset only after alarm has cleared)
Alarm Indication	Programmable: loop-powered red backlight, flashing display, alarm symbol ▲, bargraph segment flashes on alarm.
Custom Alarm Messages	Programmable for each relay/open collector: 8 characters maximum; displayed every 10 sec for 1 sec on bottom display. May be turned off.
Alarm Acknowledge	CapTouch ACK button or external digital input resets output and screen indication.
Auto Initialization	When power is applied to the meter, open collectors and relays will reflect the state of the input to the meter.
Timer Output	One-shot or Continuous Off Time Delay: 1 sec to 99:59:59 (hrs:min:sec) On Time: 1 sec to 99:59:59 (hrs:min:sec)
Stopwatch	Output turns on when started and off when stopped.

Open Collector Outputs

Rating	Isolated open collector, sinking NPN 5-30 VDC @ 150 mA maximum
Output Assignment	Pulse, Alarm, Timer, Stopwatch on/off, or Disable
Pulse Output Source	PV (PV1, PV2) or Test Frequency
Pulse Output Factor	0.000001 to 999,999.9
Pulse Width	0.5 ms @ 1 kHz; 500 ms @ 1 Hz; 50% duty cycle
Pulse Output Frequency	1,000 Hz maximum
Quadrature Pulse Output	Available for Output 2 (90° behind Output 1) 500 Hz maximum
Alarm Output Source	Assign to PV (PV1, PV2) or Digital Input

Solid-State Relays

Rating	250 VAC/VDC @ 0.5 A resistive 38 VA; 250 VAC; 0.3 A pilot duty (inductive) 13 VA; 250 VDC; 0.3 A pilot duty (inductive)
Noise Suppression	Metal oxide varistors across outputs
Relay Assignment	Pump Alternation, Alarm, Timer, Stopwatch on/off, or Disable
Alarm Output Source	Assign to PV (PV1, PV2) or Digital Input
Pump Alternation	Relays may be programmed to alternate with each pump cycle with an elapsed time override where the pumps will alternate regardless of level. Pump alternation time can be programmed for 0 to 999:59 (hrs:min)
Relay (Pump) Runtime	Meter will keep track of how long each relay (pump) has operated and display this information
Relay (Pump) Cycles	Meter will keep track of how many times the relays (pumps) have cycled and display this information

4-20 mA Transmitter Output (Passive)

Accuracy	±0.05% FS ±0.001mA
Output Source	PV1, PV2, re-transmit; reverse scaling allowed
Scaling Range	1.00 to 23.0 mA
Disable	High impedance state, less than 1 mA
Calibration	Factory calibrated 4.00 to 20.00 mA
Underrange	1.0 mA, 3.5 mA, or 3.8 mA (If input < 3.5 mA); or Off ; user selectable
Overrange	20.5 mA, 20.8 mA, or 23.0 mA (If input > 20.5 mA); or Off ; user selectable
Isolation	500 V input-to-output
Temperature Drift	0.5 µA/°C max from -40 to 75°C ambient
External Loop Power Supply	7.0 VDC to 30.0 VDC maximum
Output Loop Resistance	10-750 Ω @ 24 VDC; 10-1100 Ω @ 30 VDC

On-Board Digital Input

Function	Remote acknowledge/reset relays, reset max/min values, etc.
Contacts	2.1 VDC on contact. Connect normally open contacts across DI+ and DI-
Logic Levels	Logic High: 2.4 to 30 VDC (max) Logic Low: 0 to 0.9 VDC

General Compliance Information

Electromagnetic Compatibility

EMC Emissions	<ul style="list-style-type: none"> CFR 47 FCC Part 15 Subpart B Class A emissions requirements (USA) ICES-003 Information Technology emissions requirements (Canada) AS/NZS CISPR 11 Group 1 Class A ISM emissions requirements (Australia/New Zealand) EN 55011 Group 1 Class A ISM emissions requirements (EU) EN 61000-6-4 Emissions requirements for Heavy Industrial Environments - Generic
----------------------	---

EMC Emissions and Immunity	EN 61326-1 EMC requirements for Electrical equipment for measurement, control, and laboratory use – industrial use
-----------------------------------	--

Compliance Information (ProtEX+ Only)

Hazardous Area Approvals

CSA	Explosion-proof for use in: Class I, Division 1, Groups B, C and D Dust-ignition proof for use in: Class II/III, Division 1, Groups E, F and G; T6 Flame-proof for use in: Zone 1, Ex d IIC T6 Ta = -55 to 75°C. Enclosure: Type 4X & IP66/IP68. Certificate number: 2325749
------------	--

ATEX	Intrinsically safe for use in: Ⓜ II 1 G D Ex ia IIC T4 Ga Ex ia IIIC T200°C Da Ta = -55 to 75°C Enclosure: Type 4X & IP66/IP68 Install per Control Drawing DW2636 (contained within LIM6908-2) Certificate number: CML 18ATEX2089X
-------------	---

Explosion-proof for use in: Ⓜ II 2 G D Ex db IIC T6 Gb Ex tb IIIC T85°C Db IP68 Ta = -55 to 75°C Certificate number: Sira 10ATEX1116X
--

IECEX	Intrinsically safe for use in: Ex ia IIC T4 Ga Ex ia IIIC T200°C Da Ta = -55 to 75°C Enclosure: Type 4X & IP66/IP68 Install per Control Drawing DW2636 (contained within LIM6908-2) Certificate number: IECEX CML 18.0050X
--------------	--

Explosion-proof for use in: Ex db IIC T6 Gb Ex tb IIIC T85°C Db IP68 Ta = -55 to 75°C Certificate number: IECEX SIR 10.0056X
--

ORDERING INFORMATION

General Purpose Instruments

VantageView+ PD6907 • Feet & Inches Plastic Enclosure	
Model	Description
PD6907-GP-PL-LNN	Loop-Powered Field-Mount Feet & Inches Meter, No Options
PD6907-GP-PL-L2N	Loop-Powered Field-Mount Feet & Inches Meter, Two Solid-State Relays
PD6907-GP-PL-L3N	Loop-Powered Field-Mount Feet & Inches Meter, 4-20 mA Analog Output
PD6907-GP-PL-L5N	Loop-Powered Field-Mount Feet & Inches Meter, Two Solid-State Relays & 4-20 mA Analog Output

VantageView+ PD6908 • Decimal Models Plastic Enclosure	
Model	Description
PD6908-GP-PL-LNN	Loop-Powered Field-Mount Process Meter, No Options
PD6908-GP-PL-L2N	Loop-Powered Field-Mount Process Meter, Two Solid-State Relays
PD6908-GP-PL-L3N	Loop-Powered Field-Mount Process Meter, 4-20 mA Analog Output
PD6908-GP-PL-L5N	Loop-Powered Field-Mount Process Meter, Two Solid-State Relays & 4-20 mA Analog Output

Notes:

- All VantageView+ models come with bargraph, two open collector outputs, and one digital input standard.
- The VantageView+ comes standard with three 3/4" NPT conduit openings and two plastic plugs.

Hazardous Area Instruments

ProtEX+ PD6907 • Feet & Inches Aluminum Enclosure	
Model	Description
PD6907-HA-AL-LNN	Loop-Powered Explosion-Proof & Intrinsically Safe Feet & Inches Meter, No Options
PD6907-HA-AL-L2N	Loop-Powered Explosion-Proof & Intrinsically Safe Feet & Inches Meter, Two Solid-State Relays
PD6907-HA-AL-L3N	Loop-Powered Explosion-Proof & Intrinsically Safe Feet & Inches Meter, 4-20 mA Analog Output
PD6907-HA-AL-L5N	Loop-Powered Explosion-Proof & Intrinsically Safe Feet & Inches Meter, Two Solid-State Relays & 4-20 mA Analog Output

Notes:

- All ProtEX+ models come with bargraph, two open collector outputs, and one digital input standard.
- The ProtEX+ comes standard with two 3/4" NPT conduit holes. To order models with M20 conduit holes instead, add -21 at the end of the part number (e.g. PD6907-HA-AL-LNN-21).

ProtEX+ PD6907 • Feet & Inches Stainless Steel Enclosure	
Model	Description
PD6907-HA-SS-LNN	Loop-Powered Explosion-Proof & Intrinsically Safe Feet & Inches Meter, No Options
PD6907-HA-SS-L2N	Loop-Powered Explosion-Proof & Intrinsically Safe Feet & Inches Meter, Two Solid-State Relays
PD6907-HA-SS-L3N	Loop-Powered Explosion-Proof & Intrinsically Safe Feet & Inches Meter, 4-20 mA Analog Output
PD6907-HA-SS-L5N	Loop-Powered Explosion-Proof & Intrinsically Safe Feet & Inches Meter, Two Solid-State Relays & 4-20 mA Analog Output

ProtEX+ PD6908 • Decimal Models Aluminum Enclosure	
Model	Description
PD6908-HA-AL-LNN	Loop-Powered Explosion-Proof & Intrinsically Safe Process Meter, No Options
PD6908-HA-AL-L2N	Loop-Powered Explosion-Proof & Intrinsically Safe Process Meter, Two Solid-State Relays
PD6908-HA-AL-L3N	Loop-Powered Explosion-Proof & Intrinsically Safe Process Meter, 4-20 mA Analog Output
PD6908-HA-AL-L5N	Loop-Powered Explosion-Proof & Intrinsically Safe Process Meter, Two Solid-State Relays & 4-20 mA Analog Output

ProtEX+ PD6908 • Decimal Models Stainless Steel Enclosure	
Model	Description
PD6908-HA-SS-LNN	Loop-Powered Explosion-Proof & Intrinsically Safe Process Meter, No Options
PD6908-HA-SS-L2N	Loop-Powered Explosion-Proof & Intrinsically Safe Process Meter, Two Solid-State Relays
PD6908-HA-SS-L3N	Loop-Powered Explosion-Proof & Intrinsically Safe Process Meter, 4-20 mA Analog Output
PD6908-HA-SS-L5N	Loop-Powered Explosion-Proof & Intrinsically Safe Process Meter, Two Solid-State Relays & 4-20 mA Analog Output

Notes:

- All ProtEX+ models come with bargraph, two open collector outputs, and one digital input standard.
- The ProtEX+ comes standard with two 3/4" NPT conduit holes. To order models with M20 conduit holes instead, add -21 at the end of the part number (e.g. PD6908-HA-SS-LNN-21).

Accessories

General Accessories	
Model	Description
PD659-1MA-1MA	Signal Isolator with One 4-20 mA Input and One 4-20 mA Output
PD659-1MA-2MA	Signal Splitter with One 4-20 mA Input and Two 4-20 mA Outputs
PD659-1V-1MA	Signal Conditioner with One 0-10 VDC Input and One 4-20 mA Output
PD659-1MA-1V	Signal Conditioner with One 4-20 mA Input and One 0-10 VDC Output
PD9501	Multi-Function Calibrator
PD9502	Low-Cost Signal Generator
PDA1002	6" DIN Rail Mounting Kit
PDA1024-01	24 VDC Power Supply for DIN Rail
PDAPLUG75	3/4" NPT 316 SS Conduit Plug with Approvals
PDAPLUG75P	3/4" NPT Plastic Conduit Plug
PDAREDUCTER-75M-50F	M-3/4" NPT to F-1/2" NPT Reducer with Approvals
PDAREDUCTER-75M-M20F	M-3/4" NPT to F-M20 Reducer with Approvals
PDA-SSTAG	Stainless Steel Tag

PDA2360 Series Control Stations	
Model	Description
PDA2360-E	Emergency Button
PDA2361-A	Ack Button
PDA2361-B	Blank Button
PDA2361-R	Reset Button
PDA2361-T	Tare Button
PDA2361-S	Stop Button
PDA2361-Q	Silence Button

Note:

- Unless otherwise specified, the above accessories do not carry hazardous area approvals and are thus not suitable for location in hazardous areas.

Pipe Mounting Kits	
Model	Description
PDA6846	2" Zinc Plated Steel U-Bolt Kit with One U-Bolt
PDA6846-SS	2" Stainless Steel U-Bolt Kit with One U-Bolt

⚠ WARNING

Cancer and Reproductive Harm - www.P65Warnings.ca.gov

Disclaimer

The information contained in this document is subject to change without notice. Precision Digital Corporation makes no representations or warranties with respect to the contents hereof, and specifically disclaims any implied warranties of merchantability or fitness for a particular purpose.

©2023 Precision Digital Corporation. All rights reserved.

LDS6908_B 02/23