

# Helping deliver an efficient and secure process

## Eurotherm EPC3000 programmable controllers

Maintain the high standards of production quality and ease your cybersecurity worries



### Product at a glance

The EPC3000 range of programmable single loop process and temperature controllers maximizes efficiency and repeatability and is certified for cybersecurity communications robustness.

The controllers combine industry leading control and measurement performance with simplicity of use while remaining highly flexible.

A simple "Quick Start" configuration code, enables fast commissioning "Out of the Box" using just the instrument HMI. For applications requiring additional processing, user function block wiring provides a full range of math, logic, totalizer and specialized functions.

A highly visible three-color display with natural language status and alarm indications is easy and clear for operators to use.

EPC3000 is highly durable, with a battery-free design and extended service life.

#### Accuracy and repeatability

Process inputs are fast and accurate, with exceptional thermal stability, aiding precise and consistent control over long periods without calibration drift. Recalibration and user calibration correction functions are available to further improve accuracy.

The industry leading Eurotherm PID algorithm delivers fast reacting and repeatable control and has been enhanced for EPC3000 to further reduce overshoot. Rapid rise to operating temperature and low oscillation aids high process throughput at low scrap rates. Different PID settings may be applied in different process operating regions for optimum performance.

#### Connectivity and cybersecurity

The EPC3000 Ethernet enabled controller range is Eurotherm's first to be designed and certified to meet the stringent cybersecurity requirements of **Achilles® Communications Robustness Testing Level 1**. Ethernet communications are supported via a standard RJ45 connector, providing fast access to process and diagnostic information as well as connectivity to external PLC or plant SCADA.

Modbus RTU serial communications is also supported.

A free PC based backup and configuration tool uses a USB connection, powering the instrument from the USB interface for convenient desktop configuration.

- Precision furnace control
- Atmosphere control
- Industrial ovens
- Crystal growing
- Composite materials processing
- Heat exchangers
- Automotive paint drying
- Baking ovens
- Precision single loop controller with cybersecurity function
- Precise (0.1%) universal inputs with 50ms sample rate
- Thermocouples, resistance thermometer, mA, mV, volts, zirconia
- Exceptional thermal stability
- Fast PID response with minimal overshoot and oscillation
- Multi-programmer function with up to 10 programs of 24 steps
- Direct Ethernet RJ45 Connection certified to Achilles® CRT Level 1
- High visibility customizable display
- Quick code setup with application templates
- User function block wiring including math, logic and totalizer
- Extensive range of international approvals

# Specification

General	
Controller function	Single loop panel mount PID controller range with autotune, on/off, valve positioning (no slidewire required). Zirconia probe atmosphere control. Single loop profile/program up to 10 profiles of 24 segments. Mains and 24VDC options.
Measurement inputs	1 or 2 inputs. Accuracy $\pm 0.1\%$ reading (refer to detailed specification).
PID control	2 PID sets are available (Separate proportional band for heat and cool). Enhanced Autotuning control with cutback to minimize overshoot and oscillation. Fast reacting precision control to setpoint changes or after process disturbances. Enhanced valve positioning (unbounded) algorithm. Gain scheduling allows PID selection for a wide range of operating situations, including deviation from setpoint, absolute temperature, output level and others. AC supply voltage monitoring for feedforward. PV and SP feedforward functions.
Program/profiler	Up to 10 profiles of 24 steps. Options for 1x8, 1x24 and 10x24. Holdback ("guaranteed soak"), event outputs, time to target, ramp rate, dwell, step and call segment types. Communications compatible with Eurotherm 2400 programmer. Additional timer functions available.
User function block wiring	Optional totalizer, math, logic and multiplexing, BCD conversion, counter/timer and many other special function blocks available including zirconia and switchover.
Additional functions	Digital and analog retransmission functions. CT Input - Monitor partial load failure, load short and open circuit; Dual input functions including switchover, redundant sensor, average, min, max, Zirconia. 6 Freely configurable alarms with manual, automatic, non-latching and event types plus alarm delay function and blocking. Alarms may be inhibited in standby. 5 Recipes with 40 freely selectable parameters switchable from front panel or digital input. Scrolling parameter help and user messages displayed on event. USB backup lead and free configuration software.
Backup and configuration tools	Free Eurotherm iTools software for backup and configuration. USB Backup lead available for convenient desktop configuration and back up; powers the instrument with or without a sleeve. iTools also connects using Ethernet and serial Modbus RTU.
Ethernet	Certified to Achilles® communications robustness testing level 1.

## 3008/3004 Isolation

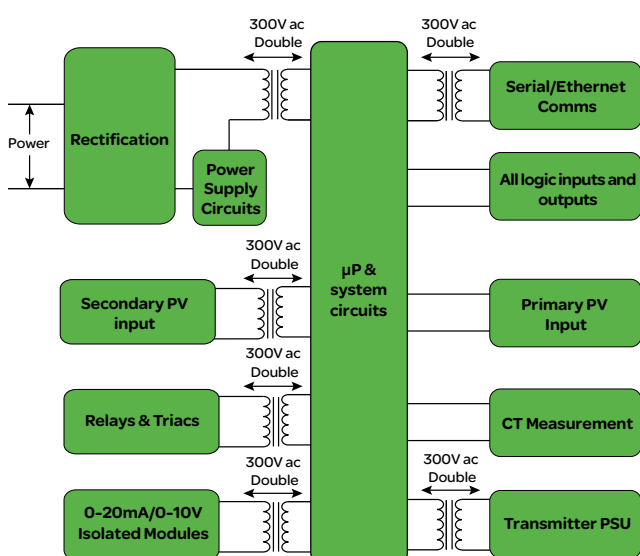

## 3016 Isolation

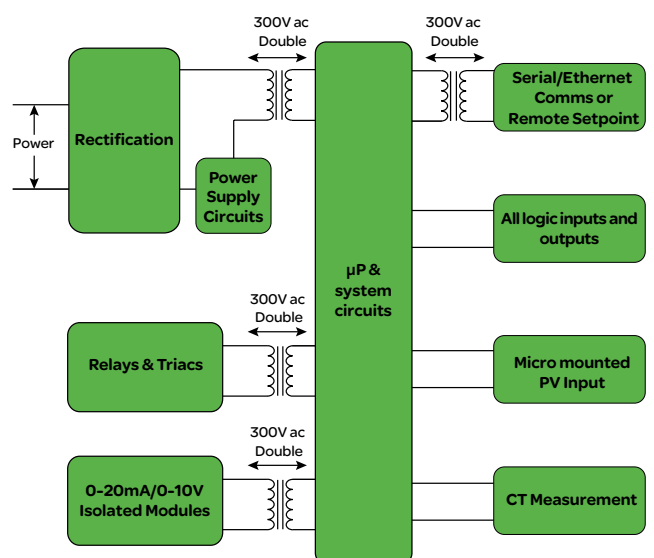

Environmental specifications, standards approvals and certifications	
Operating temperature	0 to 55°C
Storage temperature	-20 to +70°C
Operating/storage humidity	5% to 90% RH non condensing
Atmosphere	Non-corrosive, non-explosive
Altitude	<2000 Meters
Vibration and Shock	EN61131-2 (5 to 11.9Hz @ 7mm peak to peak displacement, 11.9-150Hz @ 2g, 0.5 octave min.) EN60068-2-6 Test FC, Vibration. EN60068-2-27 Test Ea and guidance, Shock.
Front of panel sealing protection	Standard bezel: EN60529 IP65, UL50E Type 12 (equivalent to NEMA12) Washdown bezel: EN60529 IP66, UL50E Type 4X (indoor use) (equivalent to NEMA4X)
Rear of panel protection	EN60529 IP10
Flammability of plastic materials	UL746C-V0
Electromagnetic compatibility (EMC)	Emissions
	Immunity
Approvals and certification	Europe
	USA, Canada
	Russia
	China
	Global
Electrical safety	EN61010-1 (installation category II, pollution degree 2)

## Mechanical Details

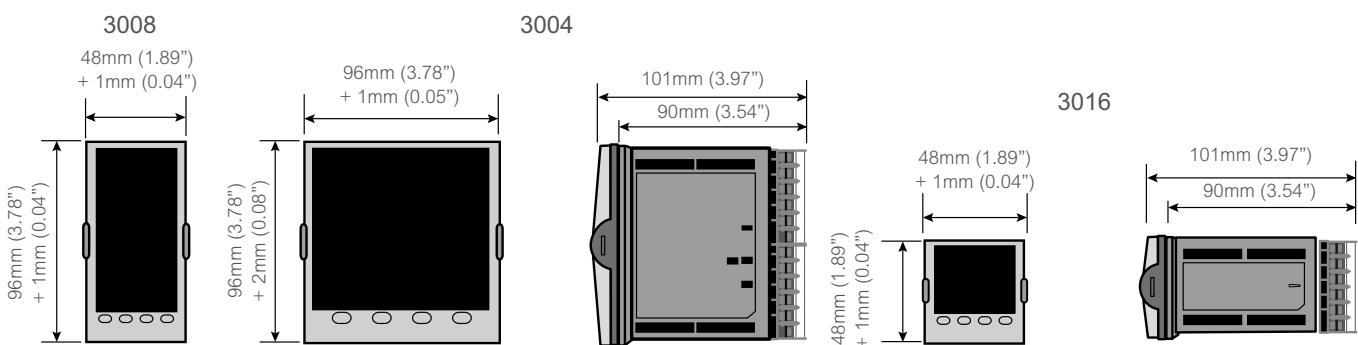

Panel cut out and weight			
	3008	3004	3016
Panel dimension	92mm (-0.0 +0.8) x 45mm (-0.0 +0.6)	92mm (-0.0 +0.8) x 92mm (-0.0 +0.8)	45mm (-0.0 +0.6) x 45mm (-0.0 +0.6)
	3.62" (-0.0 +0.03") x 1.77" (-0.0 +0.02)	3.62" (-0.0 +0.03") x 3.62" (-0.0 +0.03)	1.77" (-0.0 +0.02") x 1.77" (-0.0 +0.02)
Weight	350g	420g	250g
	12.34oz	14.81oz	8.81oz

## Inputs and outputs

### I/O and communication types

I/O and comms	3016	3008/3004
Analog inputs	1 universal input 20Hz 1 auxilliary input 4-20mA, 0-10V 4Hz (option)	1 or 2 (option) universal input 20Hz
Optional I/O modules: Form A relay output Logic I/O DC analog output TRIAC output	Up to 2, freely selectable:	Up to 3, freely selectable:
Form C relay output	1	1
Contact closure logic input	1 (option)	2
Logic I/O (open collector)	–	4 or 8 (option)
Current transformer	1 (option)	1
24V transmitter PSU	–	1
Communications	1 of the following options: RS485, RS422, RS232, Modbus RTU slave (EI Bisynch available with serial comms), Ethernet TCP.	2 of the following options: RS485 Modbus (or EI Bisynch) and Ethernet Modbus TCP (option).

### I/O specifications

Universal process inputs	
Input types	Thermocouples, PT100/PT1000 RTD, 4-20mA, 0-20mA, 10V, 2V, 0.8V, 80mV, 40mV, zirconia (oxygen probe), pyrometers. For other input types, contact your Eurotherm supplier for advice.  Accuracy $\pm 0.1\%$ reading. When subject to the necessary field calibration, 3000 series controllers manufactured by Eurotherm are suitable for use in Nadcap applications in all furnace classes as defined in AMS2750E clause 3.3.1.
Sample time	Process Inputs 50ms (20Hz). Thermocouple 62.5ms (16Hz). RTD. Automatic cycle time selection 100ms (10Hz).
Mains rejection	Series mode rejection 48-62Hz >80dB. Common mode rejection >150dB
Sensor break	AC sensor break. Break detected within 3 seconds worst case.
Input filtering	OFF to 60 seconds filter time constant.
User calibration	User 2 point input adjust (offset/gradient), transducer scaling.
Thermocouple	K, J, N, R, S, B, L, T as standard, plus 2 downloadable custom curves  Linearization accuracy CJ calibration accuracy: $< \pm 1.0^\circ\text{C}$ at $25^\circ\text{C}$ ambient CJ ambient rejection ratio: better than 40:1 from $25^\circ\text{C}$ ambient CJ automatic (internal), variable (external fixed 0, 45, $50^\circ\text{C}$ ) CJ external (measured) for 3004/3008 only

## Inputs and outputs

Input Ranges		40mV	80mV	0.8V	2V	10V	RTD (PT100/ PT1000)	mA
Range	Min	-40mV	-80mV	-800mV	-2V	-10V	0Ω (-200°C)	-32mA
	Max	+40mV	+80mV	+800mV	+2V	+10V	400Ω /4000Ω (850°C)	+32mA
Thermal stability from 25°C ambient		±0.4µV/°C ±13ppm/°C	±0.4µV/°C ±13ppm/°C	±0.4µV/°C ±13ppm/°C	±0.4µV/°C ±13ppm/°C	±0.8µV/°C ±70ppm/°C	±0.01°C/°C ±25ppm/°C	±0.16µA/°C ±113ppm/°C
Resolution		1.0µV unfiltered	1.6µV	16µV	41µV	250µV	0.05 °C	0.6µA
Electrical noise (peak to peak with 1.6s input filter)		0.8µV	3.2µV	32µV	82µV	250µV	0.05°C	1.3µA
Linearity accuracy (best fit straight line)		0.003%	0.003%	0.003%	0.003%	0.007%	0.033%	0.003%
Calibration accuracy @25°C ambient		±4.6µV ±0.053%	±7.5µV ±0.052%	±75µV ±0.052%	±420µV ±0.044%	±1.5mV ±0.063%	±0.31°C ±0.023%	±3µA ±1.052%
Input resistance		100MΩ	100MΩ	100MΩ	100MΩ	57kΩ	–	2.49Ω (1% Shunt)
Bulb current		–	–	–	–	–	190µA/ 180µA	–

### Remote setpoint auxiliary analog input (3016 Only)

Range	0 to 10V and 4 to 20mA. Max ranges -1V to 11V and 3.36mA to 20.96mA
Accuracy	<±0.25% of reading ± 1LSD, 14 Bits
Sample rate	4Hz (250ms)
Functions	Remote setpoint input Auxiliary analog input
Thermal stability	100ppm (typical) < 150ppm (worst case)
Mains rejection	Common Mode 48-62Hz > 120db, Series Mode > 90db
Input impedance	Voltage 223kΩ. Current 2.49Ω

### Current transformer input

Input range	0-50mA RMS, 48-62Hz 10Ω burden resistor fitted inside module
Measurement scaling	10, 25, 50 or 100 Amps
Calibration accuracy	<1% of reading (typical) <4% of reading (worst case)
Input functions	Partial load failure. SSR open or short circuit. Other functions including power usage totalization available using soft wiring.

### Contact closure logic inputs

Thresholds	Open > 600Ω, Closed < 300Ω
Input functions	Auto/Manual select, SP2 select, Integral hold, Control inhibit, Program run functions, Keylock, Recipe select, PID select, BCD bit, Autotune enable, Standby, PV select plus other functions available using soft wiring.

## Inputs and outputs

Logic I/O modules	
Output rating	ON 12V DC 44mA max. Minimum control cycle time 50ms (auto)
Output functions	Time proportioned heat, time proportioned cool. SSR drive alarm and event outputs, interlock outputs, other functions available using soft wiring.
Contact closure (input)	Open > 500Ω, Closed < 150Ω
Input functions	Auto/Manual select, SP2 select, Integral hold, Control inhibit, Program run functions, Keylock, Recipe select, PID select, BCD bit, Autotune enable, Standby, PV select plus other functions available using soft wiring.

Logic I/O open collector type (3004/3008 only)	
External DC PSU	15V to 35V DC
Output limit	Maximum current sinking 40mA
Output functions	Alarm and event outputs, interlock outputs, other functions available using soft wiring. Cannot be used as a control output.
Voltage sensing input	OFF < 1V, ON > 4V. Max 35V, Min -1V
Contact closure input	OFF > 28KΩ, ON < 100Ω
Input functions	Auto/Manual select, SP2 select, Integral hold, Control inhibit, Program run functions, Keylock, Recipe select, PID select, BCD bit, Autotune enable, Standby, PV select plus other functions available using soft wiring.

Relays (Form A modules and form C built in)	
Types	Form A (normally open) Form C (changeover)
Output functions	Time proportioned heat, time proportioned cool. SSR Drive. Direct valve raise/lower. Alarm and event outputs, interlock outputs, other functions available using soft wiring.
Rating	Min 100mA @ 12V, Max 2A @ 264V AC resistive. External snubber recommended.

TRIAC module	
Rating	Min 40mA, 30V RMS, Max 0.75A @ 264V AC resistive.
Output functions	Time proportioned heat, Time proportioned cool. SSR drive alarm and event outputs, interlock outputs, other functions available using soft wiring.
Surge rating	Max current surge 30A (<10ms) Max continuous operating voltage 540V peak, 385V RMS. Max surge voltage 800V peak, 565V RMS (< 10ms).

Isolated DC analog output module		
	Current output	Voltage output
Range	0-20mA	0-10V
Load resistance	<550Ω	>450Ω
Calibration accuracy	< ±(0.5% of reading + 100uA offset)	< ±(0.5% of reading + 50mV offset)
Resolution	13.5 bits resolution	13.5 bits resolution
Output functions	SCR/Power control drive. Proportional valve. Retransmission to chart recorder or other instrumentation. Other functions using soft wiring.	

## Power, communications and operator interface

### Power and transmitter PSU

Power supply, AC supply measurement and transmitter power supply	
Instrument supply voltage	100-230Vac +/- 15%, 48 to 62Hz or 24Vac +10/-15%, 48 to 62Hz 24Vdc +20/-15%, max 5% ripple voltage.
PSU rating	EPC3016 6W EPC3008/3004 9W
Power supply measurement	Only available in 100-230Vac powered instruments. Measures direct from power supply (no additional connections). Uncalibrated. Electrical noise 0.5V filtered, used by the PID function for power feedforward.
Transmitter PSU	24Vdc. 2 to 28mA load. Isolated from system (300V AC double isolation) (3004/3008 only)

### Communications

Communications	
Ethernet	Shielded grounded RJ45 connection supporting 10/100BASE-T auto sensing. Fixed IP address or DHCP
Serial	RS485 Half duplex RS422/RS232 Full duplex Baud rates 9600, 19200 Modbus RTU 8 data bits, odd/even/no parity selectable EI-Bisynch 7 data bits even parity fixed

### Operator interface

Display and operation	
Type	High visibility LCD with backlight. Flat "washdown" membrane bezel with superior panel sealing, or sculpted bezel with fully tactile keys.
Keyboard	100,000 operations typical
Main PV	3016 4 digits, 3DP; 3008 4.5 digits, 4DP; 3004 5 digits, 4DP; green/red bicolor (red in alarm)
Second line (3004/3008 only)	5 character 16 segment text or numeric
Third line	16 segment scrolling text or numeric display
Text character sets	Roman, simplified cyrillic
Additional display functions	Program status "crowsfoot" indicator. Output indicators. Alarm indication. Units. Bar graph (3004/3008 only). Communications activity indicator.
HMI functions	Configurable display contents. Configurable scroll lists for operator/supervisor. Configurable scrolling event messages. Passcode level protection with lockout period. 2 Programmable function keys (3004/3008 only)

# Rear Terminals

3016

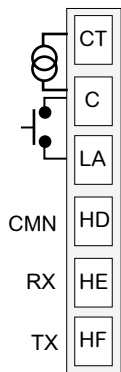
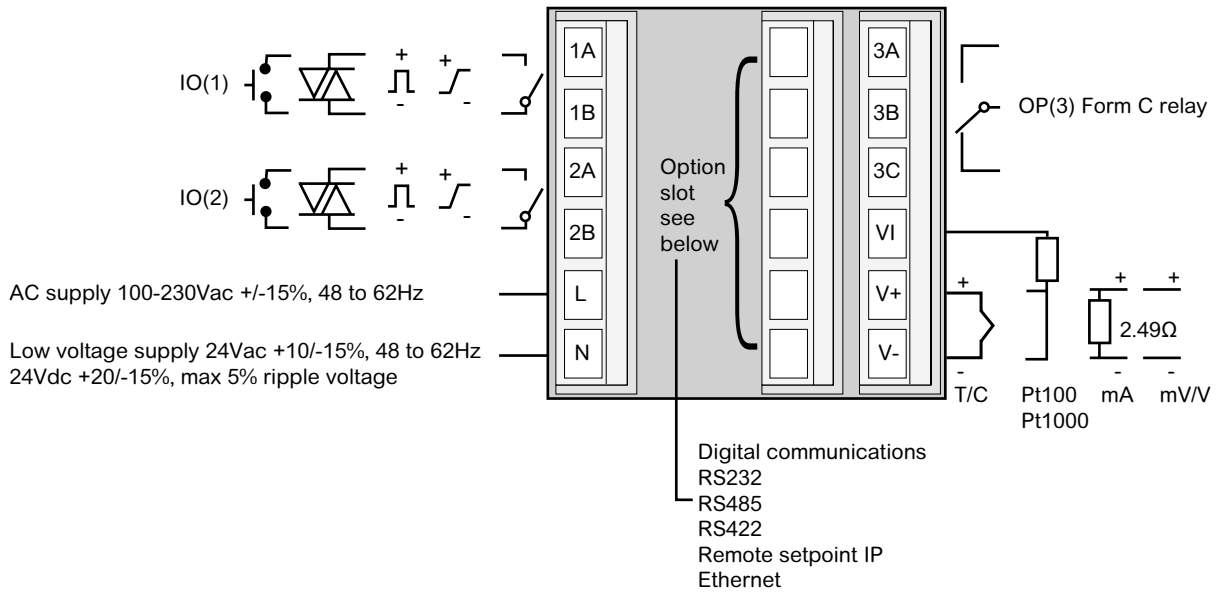

RS232  
CT INPUT  
DIGITAL INPUT

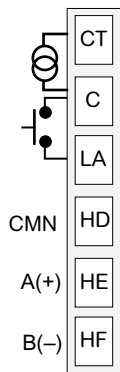

RS485  
CT INPUT  
DIGITAL INPUT

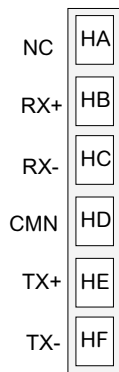

RS422

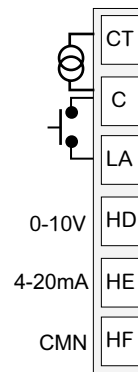

RSP INPUT  
CT INPUT  
DIGITAL INPUT

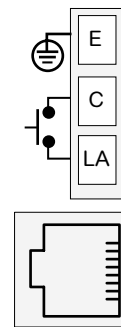

ETHERNET  
DIGITAL INPUT

### Key to symbols used in wiring diagrams

	Logic output (SSR drive)		Relay output		Contact input
	0-10V/0-20mA analog output		Triac output		Current transformer input



# Rear Terminals

3004 / 3008

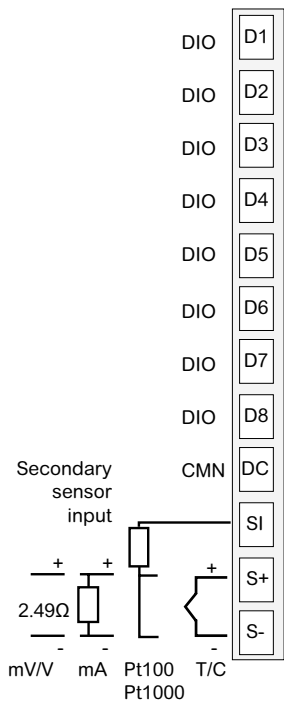
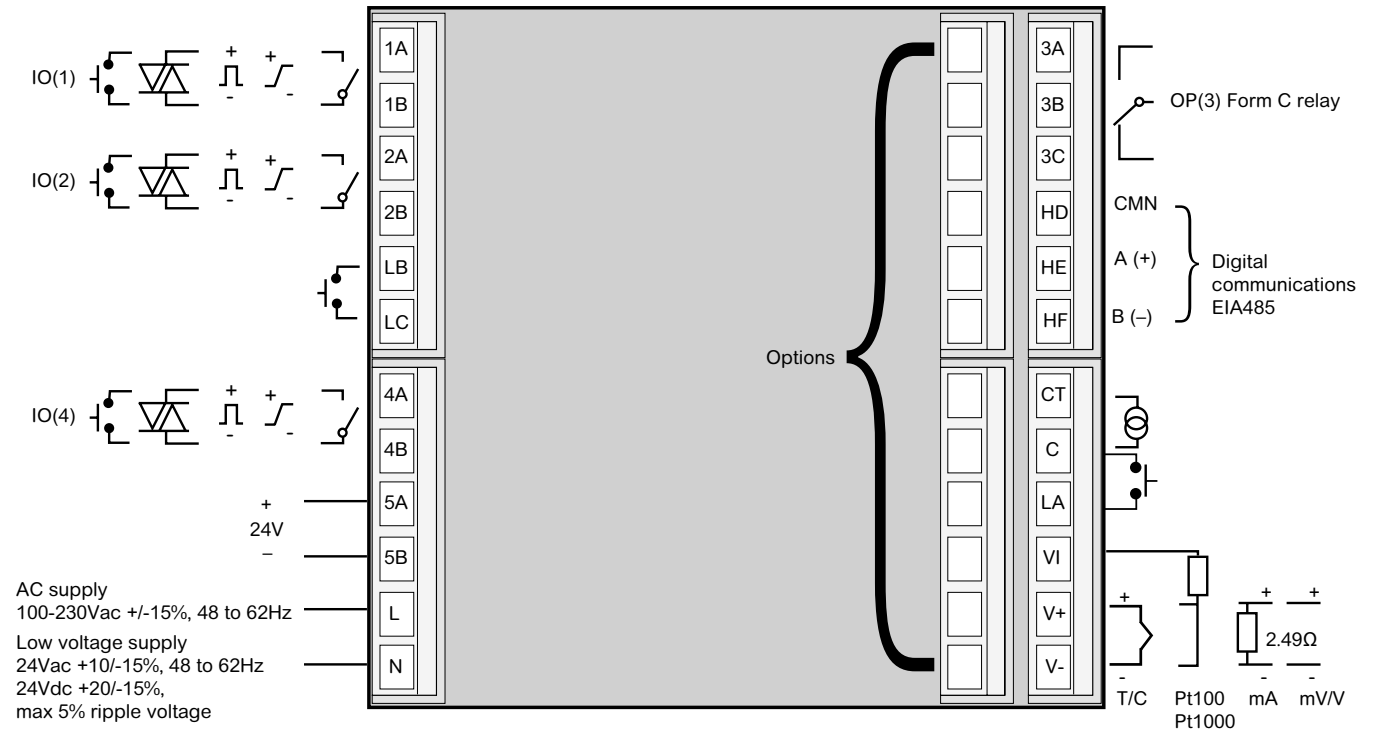

PV INPUT  
8 x DIGITAL IN / OUT

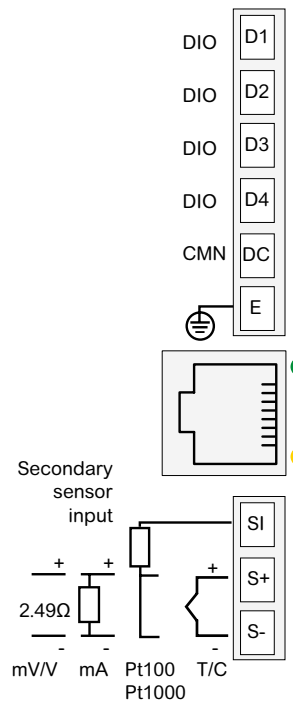

PV INPUT  
ETHERNET  
4 x DIGITAL IN / OUT

### Key to symbols used in wiring diagrams

	Logic output (SSR drive)		Relay output		Contact input
	0-10V/0-20mA analog output		Triac output		Current transformer input

## Order Codes EPC3016

	1	2	3	4	5	6	7	8	9	10	11	12
--	---	---	---	---	---	---	---	---	---	----	----	----

13	14	15
----	----	----

Note 1. Basic EPC3016 Model includes one Form C Relay

Model (see Note 1)	
EPC3016	1/16 DIN Controller

1 Type	
CC	Controller only
CP	1 x 8 Segment Basic Programmer
P1	1 x 24 Segment Advanced Programmer
P10	10 x 24 Segment Advanced Programmer

2 Supply Voltage	
VH	100 - 230Vac +/-15% (48 to 62Hz)
VL	24Vac +10%, -15% (48 to 62 Hz); 24Vdc +20, -15%; 5% ripple

3 I/O 1	
XX	Not Fitted
L2	Logic
R1	Relay Output (without snubber)
R2	Relay (supplied with external snubber)
D1	DC Output
T1	Triac (without snubber)
T2	Triac (supplied with snubber)

4 I/O 2	
XX	Not Fitted
L2	Logic
R1	Relay Output (without snubber)
R2	Relay (supplied with external snubber)
D1	DC Output
T1	Triac (without snubber)
T2	Triac (supplied with external snubber)

5 Future	
X	Not fitted

6 Future	
XX	Future

7 Serial Comms Protocol	
XX	MODBUS (Default)
EI	EI Bisynch

8 Ethernet, Comms & Remote SP	
XX	None (Default)
C1	CT Input, Dig In, and RS232
C2	CT Input, Dig In, and RS485 (3 wire)
C3	RS422 only (5 wire)
CR	CT Input, Dig In, RSP Input
CE	Digital Input, Ethernet

9 Future	
XX	Future

10 Tool Kit Blocks	
XX	None (Default 50 wires)
TK	Enabled (includes 200 wires)

11 Future	
XXX	Future

12 Bezel	
ST	Standard
WD	Washdown

13 Labels	
XXXX	None (Default)
Fnnnn	Custom Label

14 Specials	
XXXX	None (Default)

15 Future	
XX	Future

## Quick Start Codes EPC3016

	16	17	18	19	20	21	22	23	24	25	26	27
--	----	----	----	----	----	----	----	----	----	----	----	----

28
----

Note 1 Requires purchase of Communications Option (Field 8) with "Dig In"

16 Application	
X	None (Default)
1	Heat only
2	Heat/Cool
V	VPU

17 Input 1 Sensor Type	
X	Not required
M	Linear 0 to 80mVdc
V	Linear 0 to 10Vdc
2	Linear 0 to 20mA
4	Linear 4 to 20mA
B	Type B Thermocouple
J	Type J Thermocouple
K	Type K Thermocouple
L	Type L Thermocouple
N	Type N Thermocouple
R	Type R Thermocouple
S	Type S Thermocouple
T	Type T Thermocouple
P	PT100
W	PT1000

18 Input 1 Range	
X	Not required
F	Full range
1	0 to 100°C or 32 to 212°F or 273 to 373K
2	0 to 200°C or 32 to 392°F or 273 to 473K
3	0 to 400°C or 32 to 752°F or 273 to 673K
4	0 to 600°C or 32 to 1112°F or 273 to 873K
5	0 to 800°C or 32 to 1472°F or 273 to 1073K
6	0 to 1000°C or 32 to 1832°F or 273 to 1273K
7	0 to 1200°C or 32 to 2192°F or 273 to 1473K
8	0 to 1300°C or 32 to 2552°F or 273 to 1573K
9	0 to 1600°C or 32 to 2912°F or 273 to 1873K
A	0 to 1800°C or 32 to 3272°F or 273 to 2073K

19 Future	
XX	Future

20 Future	
XX	Future

21 CT Input Range	
X	Not Used
1	10A
2	25A
5	50A
6	100A
7	1000A

22 Digital Input A Function (see Note 1)	
X	Not Used
W	Alarm Acknowledge
M	Auto/Manual
R	Programmer Run/Hold
L	Keylock
K	Loop Track
P	Local Setpoint Select
T	Programmer Reset
U	Remote Setpoint Select
V	Recipe Select

23 Future	
XX	Future

24 Future	
XX	Future

25 Units	
X	Not used (Default)
C	Degrees Celsius (Default)
F	Degrees Fahrenheit
K	Kelvin

26 Future	
XX	Future

27 Warranty	
XX	Standard warranty

28 Certificate of Conformity	
XX	None required
CERT1	Supplied with Certificate of Conformity

## Order Codes EPC3008 / EPC3004

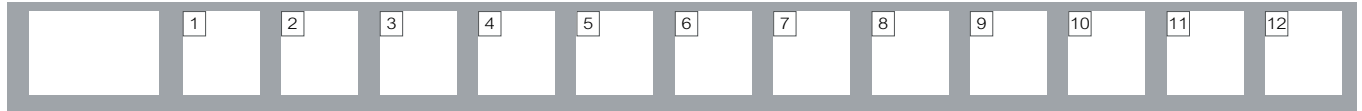

Note 1. Base EPC3008/4 Model includes RS485 Modbus RTU Slave communications, 1 Form C Relay, 2x Contact Closure Digital inputs, 1 Current Transformer Input, and 24V Transducer Power Supply

Note 2. Digital I/O on I8/IE cannot be used for PID control output

Model (see Note 1)	
EPC3008	1/8 DIN Controller
EPC3004	1/4 DIN Controller

1 Type	
CC	Controller only
CP	1 x 8 Segment Basic Programmer
P1	1 x 24 Segment Advanced Programmer
P10	10 x 24 Segment Advanced Programmer

2 Supply Voltage	
VH	100 - 230Vac +/-15% (48 to 62Hz)
VL	24Vac +10%, -15% (48 to 62 Hz); 24Vdc +20, -15%; 5% ripple

3 I/O 1	
XX	Not fitted
L2	Logic
R1	Relay Output (without snubber)
R2	Relay (supplied with external snubber)
D1	DC Output
T1	Triac (without snubber)
T2	Triac (supplied with external snubber)

4 I/O 2	
XX	Not Fitted
L2	Logic
R1	Relay Output (without snubber)
R2	Relay Output (supplied with external snubber)
D1	DC Output
T1	Triac (without snubber)
T2	Triac (supplied with external snubber)

5 I/O 4	
XX	Not Fitted
L2	Logic
R1	Relay Output (without snubber)
R2	Relay Output (supplied with external snubber)
D1	DC Output
T1	Triac (without snubber)
T2	Triac (supplied with external snubber)

6 Future	
XX	Future

7 RS485 Function	
XX	MODBUS (Default)
EI	EI Bisynch

8 Ethernet, 2nd Input & Option I/O	
XX	None (Default)
I8	Second PV Input; 8 Digital Input/Outputs:
IE (see Note 2)	Second PV Input; Ethernet (MODBUS TCP slave) + 4 x Digital I/O

9 Future	
XX	Future

10 Tool Kit Blocks	
XX	None (Default 50 wires)
TK	Enabled (includes 200 wires)

11 Future	
XXX	50 Wires (Default)

12 Bezel	
ST	Standard
WD	Washdown

13 Labels	
XXXX	None (Default)
Fnnnn	Custom Label

14 Specials	
XXXX	None (Default)

15 Future	
XX	Future

# Quick Start Codes EPC3008 / EPC3004

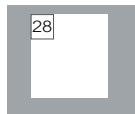
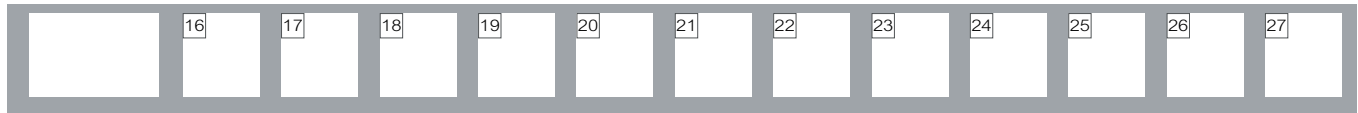

Note 1. Requires purchase of 2nd Input (Field 8)

Note 2. Requires purchase of Option I/O (Field 8)

16 Application	
X	None (Default)
1	Heat only
2	Heat/ Cool
V	VPU
C	Carbon Potential Controller (requires PV2 and Zirconia)
D	Dew Point Controller (requires PV2 and Zirconia)

17 Input 1 Sensor Type	
X	Not required
M	Linear 0 to 80mVdc
V	Linear 0 to 10Vdc
2	Linear 0 to 20mA
4	Linear 4 to 20mA
B	Type B Thermocouple
J	Type J Thermocouple
K	Type K Thermocouple
L	Type L Thermocouple
N	Type N Thermocouple
R	Type R Thermocouple
S	Type S Thermocouple
T	Type T Thermocouple
P	PT100
W	PT1000

18 Input 1 Range	
X	Not required
F	Full range
1	0 to 100°C or 32 to 212°F or 273 to 373K
2	0 to 200°C or 32 to 392°F or 273 to 473K
3	0 to 400°C or 32 to 752°F or 273 to 673K
4	0 to 600°C or 32 to 1112°F or 273 to 873K
5	0 to 800°C or 32 to 1472°F or 273 to 1073K
6	0 to 1000°C or 32 to 1832°F or 273 to 1273K
7	0 to 1200°C or 32 to 2192°F or 273 to 1473K
8	0 to 1300°C or 32 to 2552°F or 273 to 1573K
9	0 to 1600°C or 32 to 2912°F or 273 to 1873K
A	0 to 1800°C or 32 to 3272°F or 273 to 2073K

19 Input 2 Sensor Type (see Note 1)	
X	Not fitted
M	Linear 0 to 80mVdc
V	Linear 0 to 10Vdc
2	Linear 0 to 20mA
4	Linear 4 to 20mA
B	Type B Thermocouple
J	Type J Thermocouple
K	Type K Thermocouple
L	Type L Thermocouple
N	Type N Thermocouple
R	Type R Thermocouple
S	Type S Thermocouple
T	Type T Thermocouple
P	PT100
W	PT1000
Z	Zirconia (HiZ)

20 Input 2 Range (see Note 1)	
X	Not required
F	Full range
1	0 to 100°C or 32 to 212°F or 273 to 373K
2	0 to 200°C or 32 to 392°F or 273 to 473K
3	0 to 400°C or 32 to 752°F or 273 to 673K
4	0 to 600°C or 32 to 1112°F or 273 to 873K
5	0 to 800°C or 32 to 1472°F or 273 to 1073K
6	0 to 1000°C or 32 to 1832°F or 273 to 1273K
7	0 to 1200°C or 32 to 2192°F or 273 to 1473K
8	0 to 1300°C or 32 to 2552°F or 273 to 1573K
9	0 to 1600°C or 32 to 2912°F or 273 to 1873K
A	0 to 1800°C or 32 to 3272°F or 273 to 2073K

21 CT Input Range	
X	Not Used
1	10A
2	25A
5	50A
6	100A
7	1000A

22 Digital Input A Function	
X	Not Used
W	Alarm Acknowledge
M	Auto/Manual
R	Programmer Run/Hold
L	Keylock
K	Loop Track
P	Local Setpoint Select
T	Programmer Reset
U	Remote Setpoint Select
V	Recipe Select

23 Digital Input B Function	
X	Not Used
W	Alarm Acknowledge
M	Auto/Manual
R	Programmer Run/Hold
L	Keylock
K	Loop Track
P	Local Setpoint Select
T	Programmer Reset
U	Remote Setpoint Select
V	Recipe Select

24 Programmer I/O Configuration (see Note 2)	
X	Not Used/fitted
1	D1 to D8 Programmer Event Outputs 1 to 8
2	D1 to D4 = Programmer Event Outputs 1 to 4, D5 to D7 = BCD Inputs 1 to 3, D8 = Programmer Run/Hold. BCD Output to Program Number
3	D1 to D4 = Programmer Event outputs 1 to 4, D5 to D8 Programmer Run, Hold, Reset, Advance respectively
4	D1 to D4 = Programmer Event inputs 1 to 4, D5 to D7 Programmer Run/ Hold, Reset, Advance respectively, D8 Not Used. BCD Output to Program Number
5	D1 to D8 = BCD Inputs 1 to 8. BCD Output to Recipe Recall
6	D1 to D4 = BCD Inputs 1 to 4, D5 - D8 = Not used. BCD Output to Recipe Recall
7	D1 to D4 Programmer Run, Hold, Reset, Advance respectively, D5 - D8 = Not used
8	D1 to D3 Programmer Run, Hold, Reset respectively, D4 - D8 = Not Used
9	D1 to D4 = Programmer Event Outputs, D5 to D8 = Not Used

25 Units	
X	Not used (Default)
C	Degrees Celsius (Default)
F	Degrees Fahrenheit
K	Kelvin

26 Future	
XX	Future

27 Warranty	
XX	Standard warranty

28 Certificate of Conformity	
XX CERT1	None required Supplied with Certificate of Conformity

## Accessory Order Codes



Model	
EPCACC	EPC Accessories

1 Accessories	
RES2R9	2.49 Ohm Resistor
RES250	250 Ohm Resistor
RES500	500 Ohm Resistor
SNUBBER	RC SNUBBER
USBCONF	USB Backup lead
CTR10A	Current transformer 10A Primary
CTR25A	Current transformer 25A Primary
CTR50A	Current transformer 50A Primary
CTR100A	Current transformer 100A Primary
ITOOLS	Itools configuration Software